

# Solution Selection Guide

2015-2016



Automation Systems

Motion & Drives

Sensing

Control Components

Switching Components

Safety

**80+** years – founded in 1933

**\$7.5** billion annual sales (2014)

**210** locations worldwide

**36,842** employees

**40%** industrial automation

### Complete portfolio for machine automation

Sensing, Control Systems, Visualization, Drives, Robotics, Safety, Inspection, Measurement, Temperature, Switching and Control Components.

Input – Logic – Output – Safety

**7%** Annual Investment in Research & Development

Top 150 global patent assignee  
11,000+ issued and pending patents

Listed in Forbes Top 2000 largest companies in the world

Omron Corporation traded on NASDAQ: OMRNY

Top ranking in Dow Jones Sustainability Index

Thomson Reuters Top 100 Global Innovators

2013 THOMSON REUTERS

**TOP 100**  
GLOBAL INNOVATORS



Dow Jones  
Sustainability Indexes  
Member 2011/12

**NASDAQ**<sup>®</sup>

## Find Information Fast

Quick Links are unique codes assigned to Omron products listed in this guide.

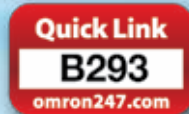

Enter Quick Link codes in the Search box on **Omron247.com** to access detailed information on products in this guide.

## Visit Omron247.com – Your single one-stop resource for:

- Technical product specifications
- 2D/3D CAD Library
- Industry solutions
- Training details
- Software downloads
- Latest product and company news
- Events calendar
- Career opportunities and more

## Find Automation Expertise – Local support and service

To find an authorized Omron Automation and Safety Distributor in your area simply use our Distributor Lookup on **Omron247.com**.

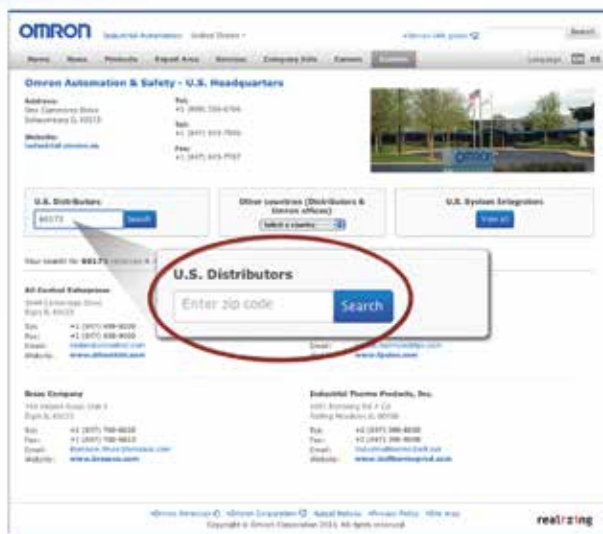

## Section Products

### Automation Systems

- A** Machine Automation Controllers
- B** Programmable Controllers
- C** Remote I/O
- D** Human Machine Interfaces
- E** Software

### Motion & Drives

- F** Motion Controllers
- G** Servo Systems
- H** AC Drives (Frequency Inverters)
- I** Robotics

### Sensing

- J** Photoelectric Sensors
- K** Fiber-optic Sensors
- L** Proximity Sensors
- M** Cordsets
- N** Photomicrosensors
- O** Limit Switches
- P** Vision Solutions
- Q** Measurement Sensors
- R** Rotary Encoders
- S** Auto Identification Systems

### Control Components

- T** Temperature Controllers
- U** Power Supplies
- V** Timers and Counters
- W** Digital Panel Meters
- X** Monitoring Products

### Switching Components

- Y** Electromechanical and Solid State Relays
- Z** Pushbutton, Indicators, Key Switches

### Safety

- AA** Light Curtains
- BB** Laser Scanners
- CC** Programmable Safety Controllers
- DD** Safety Mats, Edges and Bumpers
- EE** Safety Switches
- FF** E-stops & Rope Pull Switches
- GG** Safety Switches and Operator Controls
- HH** Safety Monitoring and Force-Guided Relays

### Index

- II** Part Number Index, NEMA and IP Ratings

# The widest range of expertly engineered automation products

Omron products are specifically designed for simple programming, operation and maintenance, as well as long service life so machine builders and end users benefit from a lower cost of ownership over a machine's life cycle.

## Automation Systems



## Motion & Drives



## Sensing

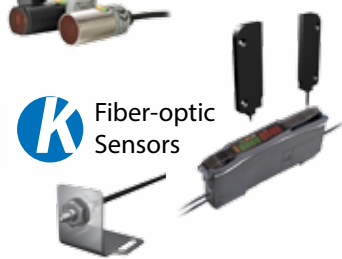



## Sensing

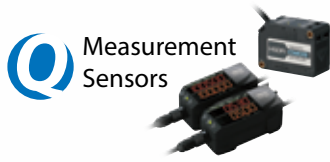

## Control Components



## Control Components



## Switching Components



## Safety

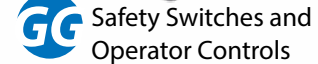
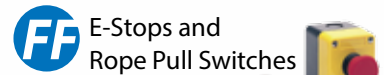
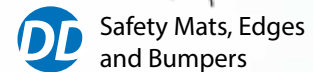

## What's the driving force behind the performance and profitability of your machines?

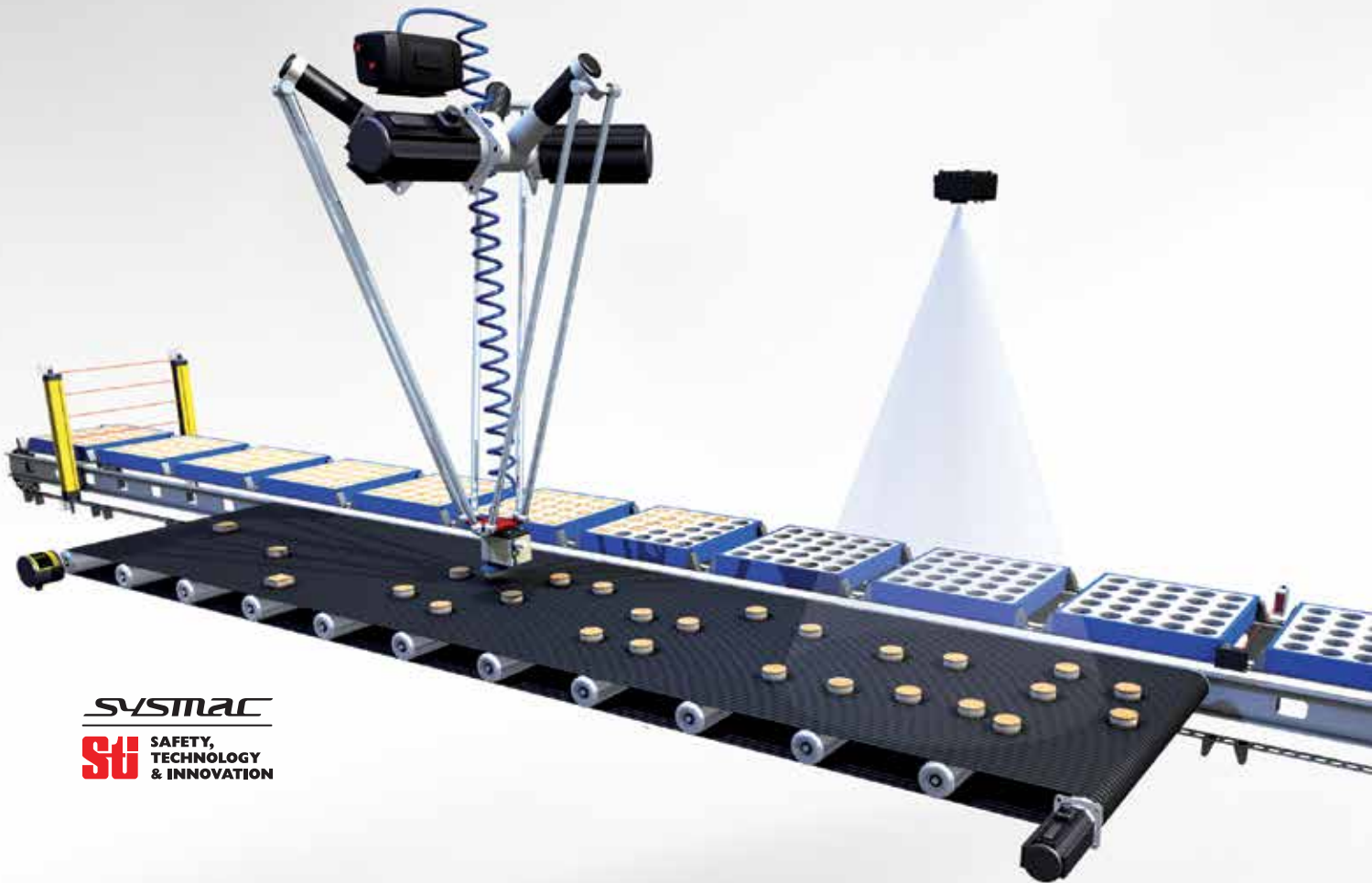

**SYSTMAC**  
**STI** SAFETY,  
TECHNOLOGY  
& INNOVATION

### *It should be your automation partner!*

At Omron, we deliver a comprehensive range of products and services designed to increase the speed, versatility, and safety of your machines.

Empower your production with highly advanced solutions that have the

proven reliability to maximize your customers' loyalty.

If you are developing a new machine or upgrading an existing model, look to Omron as your knowledgeable partner for superior automation.

**Visit us at [omron247.com](http://omron247.com) today!**

## SUPPORT FROM YOUR FIRST IDEA TO YOUR FINAL MACHINE

Let Omron introduce you to talented systems integrators, custom machine designers, field application engineers and technical support providers to help you design or retrofit your machine for greater productivity. When it is ready to deliver, we can assist with installation and commissioning. We are here to help you every step of the way.

### Area Technical Support Services

**U.S.: 800-556-6766**

**Canada: 886-986-6766**

**Mexico: 01-800-226-6766**

Our Technical Services group provides technical support, application assistance and product selection assistance. Troubleshooting support is free to our customers during normal business hours: from 8:00 AM to 8:00 PM EST.

### Application Engineering Services

**U.S.: 800-556-6766**

**Canada: 886-986-6766**

**Mexico: 01-800-226-6766**

Our knowledgeable staff can provide advanced support and engineering services at regular hourly rates. Some examples of advanced technical support services include:

- Code examples, application review, and troubleshooting
- Software installation and configuration
- Network configuration assistance
- Program conversion services

### After-Hours Technical Support

**U.S. and Canada: 800-367-4584**

After hours service is available for basic technical support for Omron products. A product support specialist will answer your call within 30 minutes to assist you. Contact Omron toll-free to schedule an onsite emergency service call.

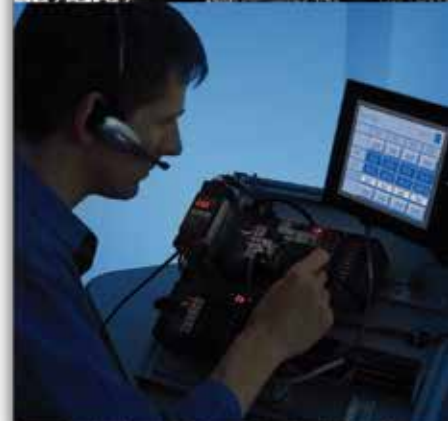

## Terms and Conditions of Sale

1. Offer; Acceptance. These terms and conditions (these "Terms") are deemed part of all quotes, agreements, purchase orders, acknowledgments, price lists, catalogs, manuals, brochures and other documents, whether electronic or in writing, relating to the sale of products or services (collectively, the "Products") by Omron Electronics LLC and its subsidiary companies ("Omron"). Omron objects to any terms or conditions proposed in Buyer's purchase order or other documents which are inconsistent with, or in addition to, these Terms.

2. Prices; Payment Terms. All prices stated are current, subject to change without notice by Omron. Omron reserves the right to increase or decrease prices on any unshipped portions of outstanding orders. Payments for Products are due net 30 days unless otherwise stated in the invoice.

3. Discounts. Cash discounts, if any, will apply only on the net amount of invoices sent to Buyer after deducting transportation charges, taxes and duties, and will be allowed only if (i) the invoice is paid according to Omron's payment terms and (ii) Buyer has no past due amounts.

4. Interest. Omron, at its option, may charge Buyer 1-1/2% interest per month or the maximum legal rate, whichever is less, on any balance not paid within the stated terms.

5. Orders. Omron will accept no order less than \$200 net billing.

6. Governmental Approvals. Buyer shall be responsible for, and shall bear all costs involved in, obtaining any government approvals required for the importation or sale of the Products.

7. Taxes. All taxes, duties and other governmental charges (other than general real property and income taxes), including any interest or penalties thereon, imposed directly or indirectly on Omron or required to be collected directly or indirectly by Omron for the manufacture, production, sale, delivery, importation, consumption or use of the Products sold hereunder (including customs duties and sales, excise, use, turnover and license taxes) shall be charged to and remitted by Buyer to Omron.

8. Financial. If the financial position of Buyer at any time becomes unsatisfactory to Omron, Omron reserves the right to stop shipments or require satisfactory security or payment in advance. If Buyer fails to make payment or otherwise comply with these Terms or any related agreement, Omron may (without liability and in addition to other remedies) cancel any unshipped portion of Products sold hereunder and stop any Products in transit until Buyer pays all amounts, including amounts payable hereunder, whether or not then due, which are owing to it by Buyer. Buyer shall in any event remain liable for all unpaid accounts.

9. Cancellation; Etc. Orders are not subject to rescheduling or cancellation unless Buyer indemnifies Omron against all related costs or expenses.

10. Force Majeure. Omron shall not be liable for any delay or failure in delivery resulting from causes beyond its control, including earthquakes, fires, floods, strikes or other labor disputes, shortage of labor or materials, accidents to machinery, acts of sabotage, riots, delay in or lack of transportation or the requirements of any government authority.

11. Shipping; Delivery. Unless otherwise expressly agreed in writing by Omron:

- Shipments shall be by a carrier selected by Omron; Omron will not drop ship except in "break down" situations.
- Such carrier shall act as the agent of Buyer and delivery to such carrier shall constitute delivery to Buyer;
- All sales and shipments of Products shall be FOB shipping point (unless otherwise stated in writing by Omron), at which point title and risk of loss shall pass from Omron to Buyer; provided that Omron shall retain a security interest in the Products until the full purchase price is paid;
- Delivery and shipping dates are estimates only; and
- Omron will package Products as it deems proper for protection against normal handling and extra charges apply to special conditions.

12. Claims. Any claim by Buyer against Omron for shortage or damage to the Products occurring before delivery to the carrier must be presented in writing to Omron within 30 days of receipt of shipment and include the original transportation bill signed by the carrier noting that the carrier received the Products from Omron in the condition claimed.

13. Warranties. (a) Exclusive Warranty. Omron's exclusive warranty is that the Products will be free from defects in materials and workmanship for a period of twelve months from the date of sale by Omron (or such other period expressed in writing by Omron). Omron disclaims all other warranties, express or implied. (b) Limitations. OMRON MAKES NO WARRANTY OR REPRESENTATION, EXPRESS OR IMPLIED, ABOUT NON-INFRINGEMENT, MERCHANTABILITY OR FITNESS FOR A PARTICULAR PURPOSE OF THE PRODUCTS. BUYER

ACKNOWLEDGES THAT IT ALONE HAS DETERMINED THAT THE PRODUCTS WILL SUITABLY MEET THE REQUIREMENTS OF THEIR INTENDED USE. Omron further disclaims all warranties and responsibility of any type for claims or expenses based on infringement by the Products or otherwise of any intellectual property right. (c) Buyer Remedy. Omron's sole obligation hereunder shall be, at Omron's election, to (i) replace (in the form originally shipped with Buyer responsible for labor charges for removal or replacement thereof) the non-complying Product, (ii) repair the non-complying Product, or (iii) repay or credit Buyer an amount equal to the purchase price of the non-complying Product; provided that in no event shall Omron be responsible for warranty, repair, indemnity or any other claims or expenses regarding the Products unless Omron's analysis confirms that the Products were properly handled, stored, installed and maintained and not subject to contamination, abuse, misuse or inappropriate modification. Return of any Products by Buyer must be approved in writing by Omron before shipment. Omron Companies shall not be liable for the suitability or unsuitability or the results from the use of Products in combination with any electrical or electronic components, circuits, system assemblies or any other materials or substances or environments. Any advice, recommendations or information given orally or in writing, are not to be construed as an amendment or addition to the above warranty. See <http://www.omron247.com> or contact your Omron representative for published information.

14. Limitation on Liability; Etc. OMRON COMPANIES SHALL NOT BE LIABLE FOR SPECIAL, INDIRECT, INCIDENTAL, OR CONSEQUENTIAL DAMAGES, LOSS OF PROFITS OR PRODUCTION OR COMMERCIAL LOSS IN ANY WAY CONNECTED WITH THE PRODUCTS, WHETHER SUCH CLAIM IS BASED IN CONTRACT, WARRANTY, NEGLIGENCE OR STRICT LIABILITY. Further, in no event shall liability of Omron Companies exceed the individual price of the Product on which liability is asserted.

15. Indemnities. Buyer shall indemnify and hold harmless Omron Companies and their employees from and against all liabilities, losses, claims, costs and expenses (including attorney's fees and expenses) related to any claim, investigation, litigation or proceeding (whether or not Omron is a party) which arises or is alleged to arise from Buyer's acts or omissions under these Terms or in any way with respect to the Products. Without limiting the foregoing, Buyer (at its own expense) shall indemnify and hold harmless Omron and defend or settle any action brought against such Companies to the extent based on a claim that any Product made to Buyer specifications infringed intellectual property rights of another party.

16. Property; Confidentiality. Any intellectual property in the Products is the exclusive property of Omron Companies and Buyer shall not attempt to duplicate it in any way without the written permission of Omron. Notwithstanding any charges to Buyer for engineering or tooling, all engineering and tooling shall remain the exclusive property of Omron. All information and materials supplied by Omron to Buyer relating to the Products are confidential and proprietary, and Buyer shall limit distribution thereof to its trusted employees and strictly prevent disclosure to any third party.

17. Export Controls. Buyer shall comply with all applicable laws, regulations and licenses regarding (i) export of products or information; (ii) sale of products to "forbidden" or other proscribed persons; and (iii) disclosure to non-citizens of regulated technology or information.

18. Miscellaneous. (a) Waiver. No failure or delay by Omron in exercising any right and no course of dealing between Buyer and Omron shall operate as a waiver of rights by Omron. (b) Assignment. Buyer may not assign its rights hereunder without Omron's written consent. (c) Law. These Terms are governed by the law of the jurisdiction of the home office of the Omron company from which Buyer is purchasing the Products (without regard to conflict of law principles). (d) Amendment. These Terms constitute the entire agreement between Buyer and Omron relating to the Products, and no provision may be changed or waived unless in writing signed by the parties. (e) Severability. If any provision hereof is rendered ineffective or invalid, such provision shall not invalidate any other provision. (f) Setoff. Buyer shall have no right to set off any amounts against the amount owing in respect of this invoice. (g) Definitions. As used herein, "including" means "including without limitation"; and "Omron Companies" (or similar words) mean Omron Corporation and any direct or indirect subsidiary or affiliate thereof.

## Certain Precautions on Specifications and Use

1. Suitability of Use. Omron Companies shall not be responsible for conformity with any standards, codes or regulations which apply to the combination of the Product in the Buyer's application or use of the Product. At Buyer's request, Omron will provide applicable third party certification documents identifying ratings and limitations of use which apply to the Product. This information by itself is not sufficient for a complete determination of the suitability of the Product in combination with the end product, machine, system, or other application or use. Buyer shall be solely responsible for determining appropriateness of the particular Product with respect to Buyer's application, product or system. Buyer shall take application responsibility in all cases. NEVER USE THE PRODUCT FOR AN APPLICATION INVOLVING SERIOUS RISK TO LIFE OR PROPERTY OR IN LARGE QUANTITIES WITHOUT ENSURING THAT THE SYSTEM AS A WHOLE HAS BEEN DESIGNED TO ADDRESS THE RISKS, AND THAT THE OMRON PRODUCT(S) IS PROPERLY RATED AND INSTALLED FOR THE INTENDED USE WITHIN THE OVERALL EQUIPMENT OR SYSTEM.

2. Programmable Products. Omron Companies shall not be responsible for the user's programming of a programmable Product, or any consequence thereof.

3. Performance Data. Data presented in Omron Company websites, catalogs and other materials is provided as a guide for the user in determining suitability and does

not constitute a warranty. It may represent the result of Omron's test conditions, and the user must correlate it to actual application requirements. Actual performance is subject to the Omron's Warranty and Limitations of Liability.

4. Change in Specifications. Product specifications and accessories may be changed at any time based on improvements and other reasons. It is our practice to change part numbers when published ratings or features are changed, or when significant construction changes are made. However, some specifications of the Product may be changed without any notice. When in doubt, special part numbers may be assigned to fix or establish key specifications for your application. Please consult with your Omron's representative at any time to confirm actual specifications of purchased Product.

5. Errors and Omissions. Information presented by Omron Companies has been checked and is believed to be accurate; however, no responsibility is assumed for clerical, typographical or proofreading errors or omissions.



## YOUR CONTROL CHALLENGES

It all starts with understanding our customer needs and their applications. Omron Automation & Safety produces a wide range of controller lines that can solve customer applications in a multitude of ways. Each controller line has its own specialties for different types of solutions.

Omron's flagship series, the Sysmac Machine Automation Controller (MAC), integrates Logic, Motion, Vision, and Safety all into One Controller, over One Network, with One Software. Omron's PLC and Programmable Relay lines provide competitive solutions for other application focuses, shown below.

FULLY INTEGRATED

REDUNDANCY



Sysmac NJ/NX



CS1 PLC



CJ2 PLC



CP1 PLC

RELAY REPLACEMENT







ZEN

MULTI-NETWORK



STAND-ALONE

# Selection Table

	Machine Automation Control - NJ/NX Series			
				
Model	NJ1	NJ3	NJ5	NX7
Max digital I/O points <sup>*1</sup>	2560 points max., plus EtherCAT slave I/O capacity			64,000 EtherCAT slave I/O capacity (local I/O future capability)
CPU features <sup>*1</sup>	<ul style="list-style-type: none"> <li>• Entry-level Sysmac CPU</li> <li>• Built-in EtherNet/IP &amp; EtherCAT network interface</li> <li>• Built-in 0 or 2 axes of Motion</li> <li>• Advanced Motion Capabilities</li> <li>• Local and remote I/O options including Safety</li> <li>• Complete Sysmac solution configured, programmed, and commissioned using Sysmac Studio software</li> </ul>	<ul style="list-style-type: none"> <li>• Mid-level Sysmac CPU</li> <li>• Built-in EtherNet/IP &amp; EtherCAT network interfaces</li> <li>• Built-in 4 or 8 axes of Motion</li> <li>• Advanced Motion Control capabilities</li> <li>• Local and remote I/O options including Safety</li> <li>• Complete Sysmac solution configured, programmed, and commissioned using Sysmac Studio software</li> </ul>	<ul style="list-style-type: none"> <li>• High-level Sysmac CPU</li> <li>• Built-in EtherNet/IP &amp; EtherCAT network interfaces</li> <li>• Built-in 16, 32, or 64 axes of Motion</li> <li>• Advanced Motion Control capabilities</li> <li>• Local and remote I/O options including Safety</li> <li>• Complete Sysmac solution configured, programmed, and commissioned using Sysmac Studio software</li> </ul>	<ul style="list-style-type: none"> <li>• Highest-level Sysmac CPU</li> <li>• Built-in EtherNet/IP (x2) &amp; EtherCAT network interfaces</li> <li>• Built-in 128 or 256 axes of Motion</li> <li>• Advanced Motion Control capabilities</li> <li>• Remote I/O options including Safety (local I/O future capability)</li> <li>• Complete Sysmac solution configured, programmed, and commissioned using Sysmac Studio software</li> </ul>
Cycle Time	5.0 ns minimum	3.0 ns minimum	1.9 ns minimum	0.76 ns minimum
Program memory	3MB (60k steps)	5MB (100k steps)	20MB (400k steps)	80MB (1,600k steps)
Data memory (retained/non-retained)	0.5 / 2 MB		2 / 4 MB	4 / 256 MB
External memory	2 GB SD card			
Special function units	<ul style="list-style-type: none"> <li>• High-speed counter 500 kHz</li> <li>• Temperature controller</li> <li>• Protocol macro</li> <li>• RFID sensor control unit</li> <li>• High-speed I/O</li> <li>• Serial communications</li> </ul>			
Fieldbus master	<ul style="list-style-type: none"> <li>• DeviceNet</li> <li>• EtherNet/IP</li> <li>• PROFIBUS-DP</li> <li>• PROFINET</li> <li>• EtherCAT</li> <li>• CompoNet</li> </ul>			EtherCAT
Remote I/O	NX-Series Slice I/O			





\*1 Some features listed are not available for all CPU types within each series. Please review specifications for more information on CPU features and performance.

# Automation Systems Overview

	Rack PLC series		Modular PLC series	
				
Model	CS1G/H	CS1D	CJ2M	CJ2H
Max digital I/O points*1	5120		2560	
CPU features*1	<ul style="list-style-type: none"> <li>• High I/O capacity</li> <li>• Inner board support</li> <li>• Large program capacity</li> <li>• Backwards compatible</li> <li>• Easy backups</li> <li>• Real time clock</li> </ul>	<ul style="list-style-type: none"> <li>• Redundant CPU</li> <li>• Redundant power supply</li> <li>• Hot swapping</li> <li>• High I/O capacity</li> <li>• Inner board support</li> <li>• Large program capacity</li> <li>• Backwards compatible</li> <li>• Easy backups</li> <li>• Real time clock</li> </ul>	<ul style="list-style-type: none"> <li>• USB port standard</li> <li>• Built-in Ethernet/IP port</li> <li>• High-speed I/O units</li> <li>• Option board plug-in</li> <li>• Structures and arrays</li> <li>• Tag data links</li> <li>• Compact size</li> <li>• No backplane required</li> <li>• Large program capacity</li> <li>• Function Block memory</li> <li>• Easy backups</li> <li>• Real time clock</li> </ul>	<ul style="list-style-type: none"> <li>• USB port standard</li> <li>• Built-in Ethernet/IP port</li> <li>• High-speed I/O units</li> <li>• Structures and arrays</li> <li>• Tag data links</li> <li>• Synchronous I/O</li> <li>• Compact size</li> <li>• No backplane required</li> <li>• Extra Large program capacity</li> <li>• Easy backups</li> <li>• Real time clock</li> </ul>
Instruction Execution time (bit instruction)	0.04/0.02 μs		0.04 μs	0.016 μs
Program memory	10 to 250K steps		5 to 60K steps	50 to 400K steps
Data memory (retained/non-retained)	64 to 448K words (retained)		64 to 160K words	160 to 832K words
External memory	Up to 512MB			
Analog I/O	• Temperature control unit		• Analog I/O unit • Temperature control unit	
Special function units	<ul style="list-style-type: none"> <li>• Temperature control</li> <li>• SSI encoder input</li> <li>• High-speed counters (500 kHz)</li> <li>• Position control</li> <li>• Motion control</li> <li>• Process control</li> <li>• Protocol macro</li> <li>• RFID sensor unit</li> </ul>		<ul style="list-style-type: none"> <li>• Temperature control</li> <li>• High-speed counters (500 kHz)</li> <li>• SSI encoder input</li> <li>• Position control</li> <li>• Protocol macro</li> <li>• RFID sensor unit</li> </ul>	<ul style="list-style-type: none"> <li>• Temperature control</li> <li>• High-speed counters (500 kHz)</li> <li>• SSI encoder input</li> <li>• Position control</li> <li>• Protocol macro</li> <li>• RFID sensor unit</li> <li>• High-speed I/O</li> <li>• Synchronised Position</li> </ul>
Fieldbus master	<ul style="list-style-type: none"> <li>• Ethernet</li> <li>• EtherNet/IP</li> <li>• Controller Link</li> <li>• DeviceNet</li> <li>• PROFIBUS-DP</li> <li>• PROFINET</li> <li>• ModBus</li> <li>• CompoNet</li> <li>• CompoBus/S</li> <li>• CAN (freely configurable)</li> </ul>			

\*1 Some features listed are not available for all CPU types within each series. Please review specifications for more information on CPU features and performance.

# Selection Table

		Micro PLC Series			Programmable Relays
					
Model		CP1E	CP1L	CP1H	ZEN
Max I/O points <sup>1</sup>		160	180	320 <sup>2</sup>	44
Built-in	Digital I/O	10 to 60		20 or 40	10 or 20
	Interrupt inputs	4 or 6	2, 4, or 6	6 or 8	0
	High-speed Counter inputs	5 or 6	4		1
	Pulse outputs*1	2		4	0
CPU features*1	<ul style="list-style-type: none"> <li>• USB port standard</li> <li>• Expansion I/O units</li> <li>• Quick-response inputs</li> <li>• Input interrupts</li> <li>• High-speed counter</li> <li>• Pulse output w/ PWM</li> <li>• Built-in RS-232C port</li> <li>• Serial option boards</li> <li>• Real time clock</li> <li>• 2 Analog adjusters</li> </ul>	<ul style="list-style-type: none"> <li>• USB port standard</li> <li>• Expansion I/O units</li> <li>• Quick-response inputs</li> <li>• Input interrupts</li> <li>• High-speed counter</li> <li>• Pulse output with PWM</li> <li>• Built-in RS-232C or Ethernet port</li> <li>• Option board slots</li> <li>• Real time clock</li> <li>• 1 Analog adjuster</li> <li>• 1 External analog input</li> </ul>	<ul style="list-style-type: none"> <li>• USB port standard</li> <li>• Expansion I/O units</li> <li>• CJ-series Special I/O Units</li> <li>• CJ-series CPU Bus Units</li> <li>• Quick-response inputs</li> <li>• Input interrupts</li> <li>• High-speed counter</li> <li>• Pulse output with PWM</li> <li>• Built-in RS-232C port</li> <li>• Option board slots</li> <li>• Real time clock</li> <li>• 1 Analog adjuster</li> <li>• 1 External analog input</li> <li>• LED display, 2 digit</li> </ul>	<ul style="list-style-type: none"> <li>• 4 line x 12 character LCD display</li> <li>• High speed counter (150 Hz)</li> <li>• Twin timer</li> <li>• Weekly and calendar timers</li> <li>• Analog input comparators</li> <li>• Slim 8 I/O expansion units</li> <li>• RS-485 serial communication</li> <li>• ZEN Support Software offers simulation capability, ladder programming, parameter setting, monitoring and printing in a Windows environment</li> </ul>	
Instruction Execution time (bit instruction)	1.10 µs	0.61 µs	0.10 µs	–	
Program memory	2 or 8K steps	5 or 10K steps	20K steps	96 lines	
Data memory	2 or 8K words	10 or 32K words	32K words	–	
External memory	–	Memory cassette	Memory cassette	–	
Analog I/O	<ul style="list-style-type: none"> <li>• Built-in for E-NA model (2 in + 1 out)</li> <li>• Analog I/O Expansion Units</li> <li>• Temperature Input Expansion Units</li> </ul>	<ul style="list-style-type: none"> <li>• Analog I/O Expansion Units</li> <li>• Temperature Input Expansion Units</li> <li>• Built-in for L-E models (2 in.)</li> </ul>	<ul style="list-style-type: none"> <li>• Built-in for XA model (4 in + 2 out)</li> <li>• Analog I/O Expansion Units</li> <li>• Temperature Input Expansion Units</li> <li>• CJ Analog I/O Units</li> <li>• CJ Temperature Units</li> </ul>	<ul style="list-style-type: none"> <li>• 2 analog voltage inputs , 0-10 V (DC only)</li> </ul>	
Special function units	–	–	<ul style="list-style-type: none"> <li>• CJ-series Special I/O Units</li> <li>• CJ-series CPU Bus Units</li> </ul>	–	
Fieldbus master	–	–	<ul style="list-style-type: none"> <li>• Ethernet</li> <li>• EtherNet/IP</li> <li>• Controller Link</li> <li>• DeviceNet</li> <li>• PROFIBUS-DP</li> <li>• PROFINET</li> <li>• ModBus</li> <li>• CompoNet</li> <li>• CompoBus/S</li> <li>• CAN (freely configurable)</li> </ul>	–	
Fieldbus I/O	<ul style="list-style-type: none"> <li>• PROFIBUS-DP</li> <li>• CompoBus/S</li> <li>• DeviceNet</li> </ul>			• N/A	

\*1 Some features listed are not available for all CPU types within each series. Please review specifications for more information on CPU features and performance.

\*2 Represents local I/O capacity. If a fieldbus master is used more I/O is possible.

## Contents

<b>Sysmac Machine Automation Controllers</b>		
NX/ NJ	Integrated Solutions	A-ii
	Basic Configuration	A-1
	CPUs	A-3
	Power Supplies	A-3
	Compatible I/O Units	A-4
NX	Modular and Safety I/O	A-5

## SYSMAC INTEGRATED SOLUTIONS



A

## CPU System Configuration

Select CPU Power Supply, and CPU\*

\*Note: Local NX I/O is a future capability

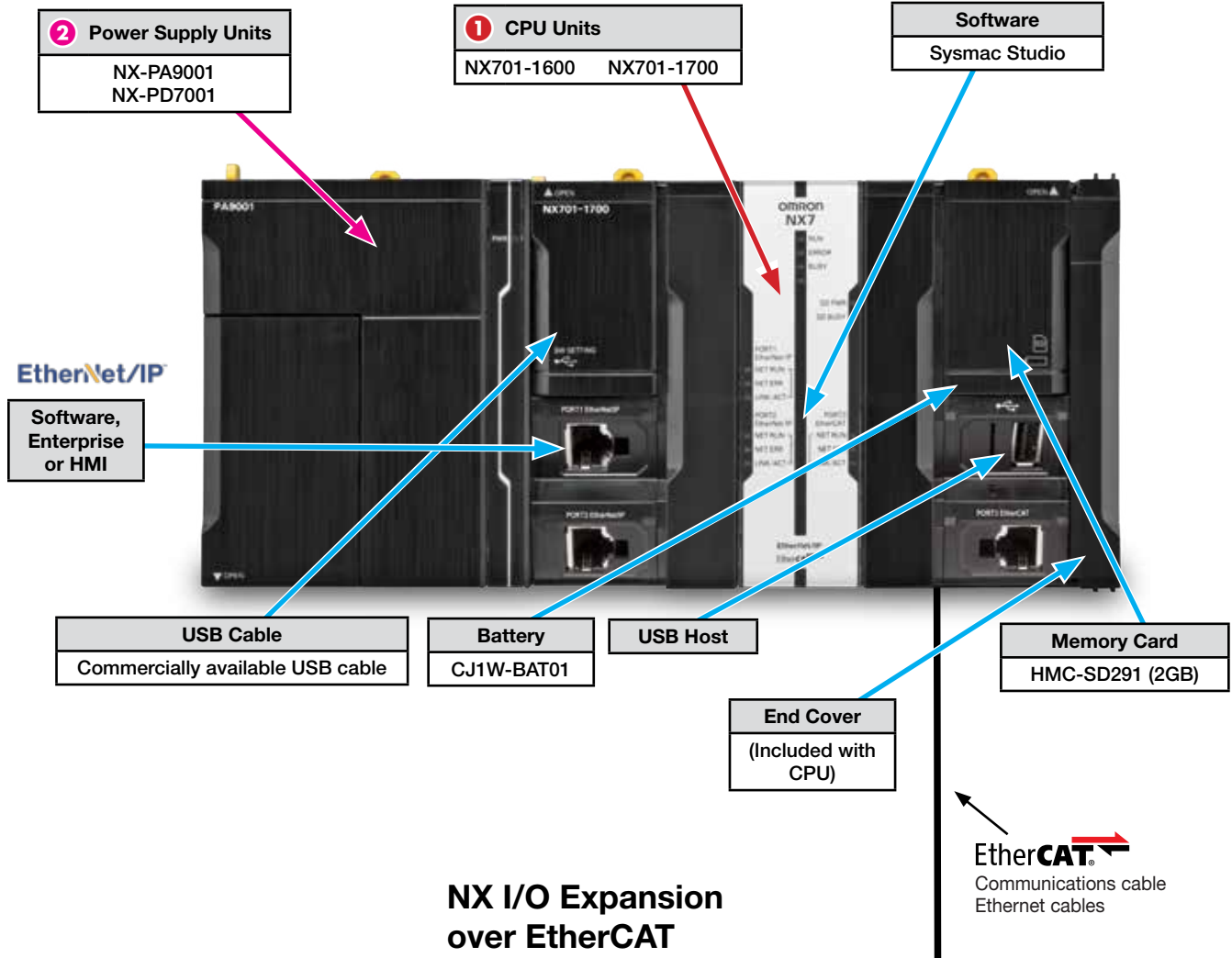

## NX I/O Expansion over EtherCAT

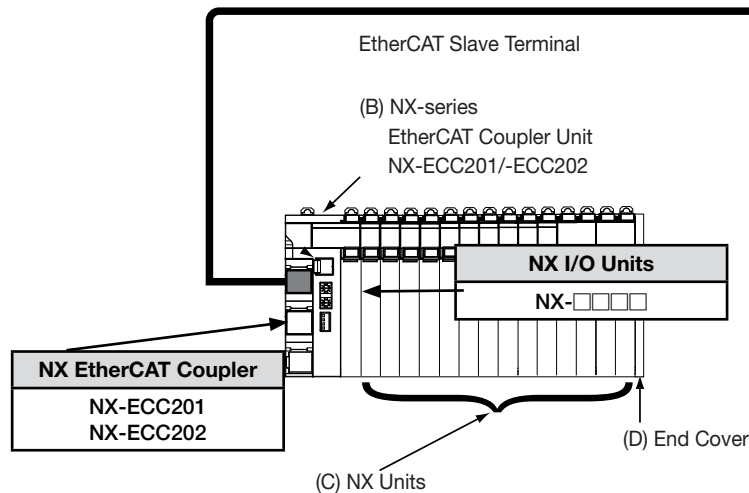

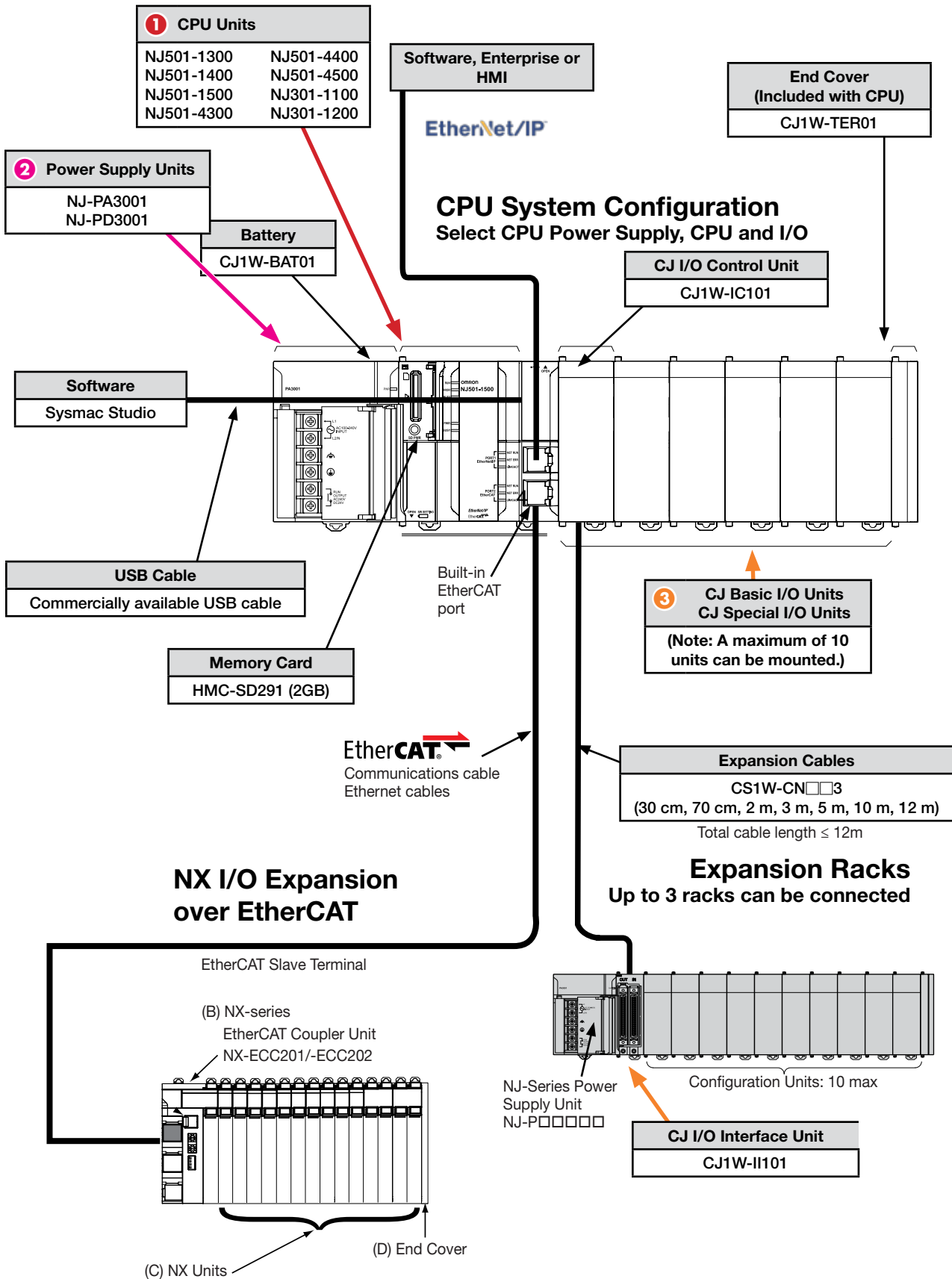



A

## Fully Integrated Control

The NX/NJ-Series includes capabilities for seamless integration of Logic, Motion, Vision, Safety, Networks, and Enterprise level control. Selectable models based on application requirements.

- Built-in EtherNet/IP & EtherCAT network interfaces
- Built-in 0 to 256 axes of advanced motion control capabilities
- Local and remote I/O options including Failsafe Safety over EtherCAT
- Available built-in SQL Database Connectivity
- Available built-in Robot Kinematics
- Available SECS/GEM Protocol
- Complete Sysmac Solution configured, programmed, and commissioned using Sysmac Studio software (see Quick Link L432)



## 1 Sysmac NJ CPUs

Description	Program capacity	I/O capacity	Maximum number of units	Built-in network ports	Cycle Time	EtherCAT Slaves	Motion control axes	Cam Tables	SQL	SECS/GEM	Robot kinematics Model	Model			
NJ-Series CPU Unit	3MB (60K step, 450 POU, 2.5MB Variable 2.5MB Variable)	2,560 points local (8,960 with NX I/O)	10 per CPU or expansion rack; 40 total per CP	EtherCAT, EtherNet/IP	1/2/4 ms	64	-	-	No	No	No	NJ101-9000			
							2	160	No	No	No	NJ101-1000			
	4	No					No		No	NJ301-1100					
	8	No					No	No	NJ301-1200						
	20MB (400K step, 3,000 POU, 6MB Variable)	2,560 points local (66,560 with NX I/O)			.5/1/2/4 ms	192	16	640	No	No	No	No	No	No	NJ501-1300
									Yes	No	No	No	No	No	NJ501-1320
									No	Yes	No	No	No	No	NJ501-1340
									No	No	Yes	No	No	No	NJ501-4300
							No	No	1 only	No	No	No	NJ501-4310		
							No	No	No	No	No	No	NJ501-1400		
							Yes	No	No	No	No	No	NJ501-1420		
							No	No	Yes	No	No	No	NJ501-4400		
	No	No			No	No	No	No	NJ501-1500						
	Yes	No			No	No	No	No	NJ501-1520						
No	No	Yes	No	No	No	NJ501-4500									
NX-Series CPU Unit	80MB (1,600K step, 6,000 POU, 260MB Variable)	64,000 with NX I/O	None *Future capability	EtherCAT, EtherNet/IP (x2)	.125/.25/.5/1/2/4/8 ms	512	128		No	No	No	NX701-1600			
							256		No	No	No	NX701-1700			

## 2 Power Supplies

Description	Input supply voltage	Output current		Output capacity	Built-in feature	Model
		5 VDC	24 VDC			
NJ-Series AC power supply unit	100 to 240 VAC	6.0 A	1.0 A	30W	RUN output	NJ-PA3001
NJ-Series DC power supply unit	24 VDC					NJ-PD3001
NX-Series AC power supply unit	100 to 240 VAC	unnecessary *future capability		90W		NX-PA9001
NX-Series DC power supply unit	24 VDC			70W		NX-PA7001

## Optional SD Memory Card

Description	Specifications	Model
SD memory card	Flash memory 2 GB	HMC-SD291

## Sysmac NJ Compatible I/O & Expansion Units

The Sysmac NJ CPU uses the same local basic I/O and special I/O units as the CJ-Series PLC. More details on these units can be found in the CJ PLC section (B). All compatible I/O units are easily selected and configured within the Sysmac Studio software.



### 3 Basic I/O Units

Points	8-point units	16-point units	32-point units	64-point units
Input units	DC: CJ1W-ID201 AC: CJ1W-IA201	DC: CJ1W-ID211 CJ1W-ID212 (high-speed) AC: CJ1W-IA111	DC: CJ1W-ID231 CJ1W-ID232 CJ1W-ID233 (high speed)	DC: CJ1W-ID261 CJ1W-ID262
Output units	Relay contact (independent commons): CJ1W-OC201 Triac: CJ1W-OA201 Transistor: CJ1W-OD201 CJ1W-OD202 CJ1W-OD203 CJ1W-OD204	Relay contact: CJ1W-OC211 Transistor: CJ1W-OD211 CJ1W-OD212 CJ1W-OD213 (high speed)	Transistor: CJ1W-OD231 CJ1W-OD232 CJ1W-OD233 CJ1W-OD234 (high speed)	Transistor: CJ1W-OD261 CJ1W-OD262 CJ1W-OD263
Mixed I/O units	--	--	16 DC inputs, 16 transistor outputs: CJ1W-MD231 CJ1W-MD23 CJ1W-MD233	32 DC inputs, 32 transistor outputs: CJ1W-MD261 CJ1W-MD263 32 DC inputs, TTL outputs: CJ1W-MD563
Other units	--	Quick response input: CJ1W-IDP01	--	--

### 3 Special I/O and CPU Bus Units

Process	Positioning	Communications	RFID Tracking
Universal inputs, isolated outputs: CJ1W-PH41U CJ1W-AD04U	High-speed counter: CJ1W-CT021, CJ1W-CTL41-E	Serial (high speed): CJ1W-SCU22, CJ1W-SCU32 CJ1W-SCU42	Control 1 antenna: CJ1W-V680C1 Control 2 antennas: CJ1W-V680C2
Isolated DC input: CJ1W-PDC15		DeviceNet: CJ1W-DRM21 EtherNet/IP: CJ1W-EIP21 PROFIBUS-DP: CJ1W-PRM21 PROFINET-IO: CJ1W-PNT21 RS-422A converter: CJ1W-CIF11	
Analog input: 4-point: CJ1W-AD042 (high speed) CJ1W-AD041-V1 8-point: CJ1W-AD081-V1			
Analog output: 4-point CJ1W-DA042V (high speed) 8-point: CJ1W-DA08V, CJ1W-DA08C 4-point: CJ1W-DA041 2-point: CJ1W-DA021			
Analog I/O: 4 inputs, 2 outputs: CJ1W-MAD42			
Temperature controller: CJ1W-TC003, CJ1W-TC004, CJ1W-TC103, CJ1W-TC104, CJ1W-TS561, CJ1W-TS562			

## Speed and Accuracy for Machine Performance

The NX I/O system offers a wide variety of I/O devices. Its ultra-fast internal bus system is synchronized with the Distributed Clock of the EtherCAT network. The resulting system-wide deterministic I/O operation allows machine builders to improve machine production rates and output quality.

NX-series I/O covers a full range of units, including standard and high-speed digital I/O's, various performance levels in analog I/O, encoder inputs and pulse outputs.

- Over 100 models of I/O units including position control, temperature inputs and integrated safety
- High-speed I/O units synchronised with the EtherCAT cycle
- The NX I/O technology provides deterministic I/O response with nanosecond resolution
- Automatic backup/restore of all I/O unit parameters
- Detachable front connector with push-in type screw-less terminals in all NX I/O units
- Slim design: up to 16 I/O points in just 12 mm width

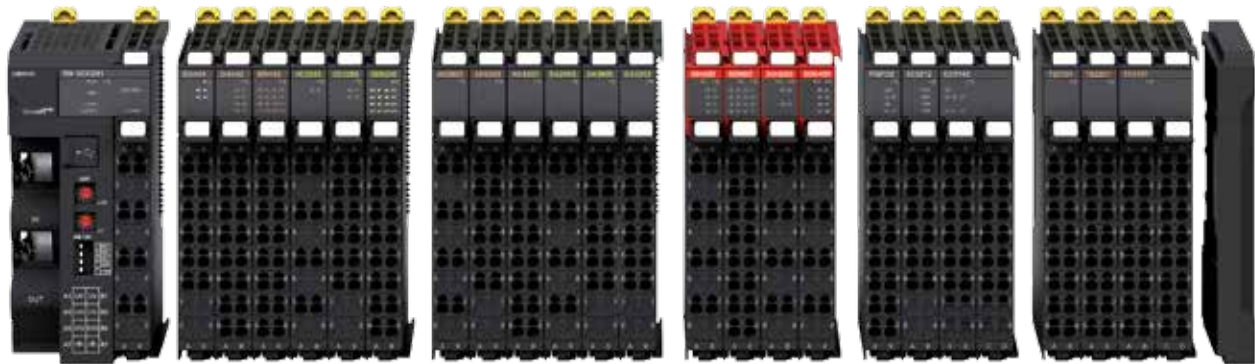

### EtherCAT coupler

- Up to 1024 byte input/1024 byte output
- Automatic backup/restore of all I/O unit parameters. Except Safety Control unit and Safety I/O units
- Connect CJ SC or Logix controllers over Ethernet IP
- Up to 63 units per coupler

### Digital I/O

- Units for 4, 8 or 16 points
- Standard, high-speed and time-stamp models
- 16/32 point high density

### Analog I/O

- $\pm 10V$  voltage and 4-20 mA current signals
- 2, 4 or 8 channels per input unit

### Safety I/O

- Up to 8 safety input points per unit
- Freely allocation of the Safety I/O units on the internal high speed bus

### Positioning interface\*

- Encoder input units for connection of external axes to the Sysmac system
- Incremental and absolute encoder support
- Positioning control unit with pulse train output

### Temperature inputs

- Thermocouple or RTD inputs, 2 or 4 per unit

### End Cover

\* Excludes Ethernet/IP coupler

# Machine Automation Controllers

---

## Contents

<b>Modular PLC</b>		
CJ2- Series	Modular PLC	B-2
	Power Supplies & CPU Units	B-3
	Communication Units	B-4
	Digital I/O Units	B-5
	Digital analog Units	B-6
	Temperature Control Units	B-7
	Pulse I/O & Rack Connectivity	B-8
<b>Rack PLC</b>		
CS1- Series	Rack PLC	B-9
	CPU Units & Power Supplies	B-10
	Backplanes & Communication Units	B-11
	Digital I/O Units	B-12
	Analog and Process I/O Units	B-13
	Accessories	B-14
<b>Micro PLCs</b>		
CP1H	CPU Units	B-15
CP1L	CPU Units	B-16
CP1E	CPU Units	B-17
CP	Expansion Units, Options for CPU Units	B-18
<b>Programmable Relays</b>		
ZEN	CPU Units / Expansion Units	B-20

**B**

## Fast and Powerful CPUs for Any Task

The CJ2 platform is a scalable architecture that allows you to pick and choose the CPU and I/O based on your needs. Depending on your application, you have the ability for advanced motion control, multi-network communications and small scale systems.

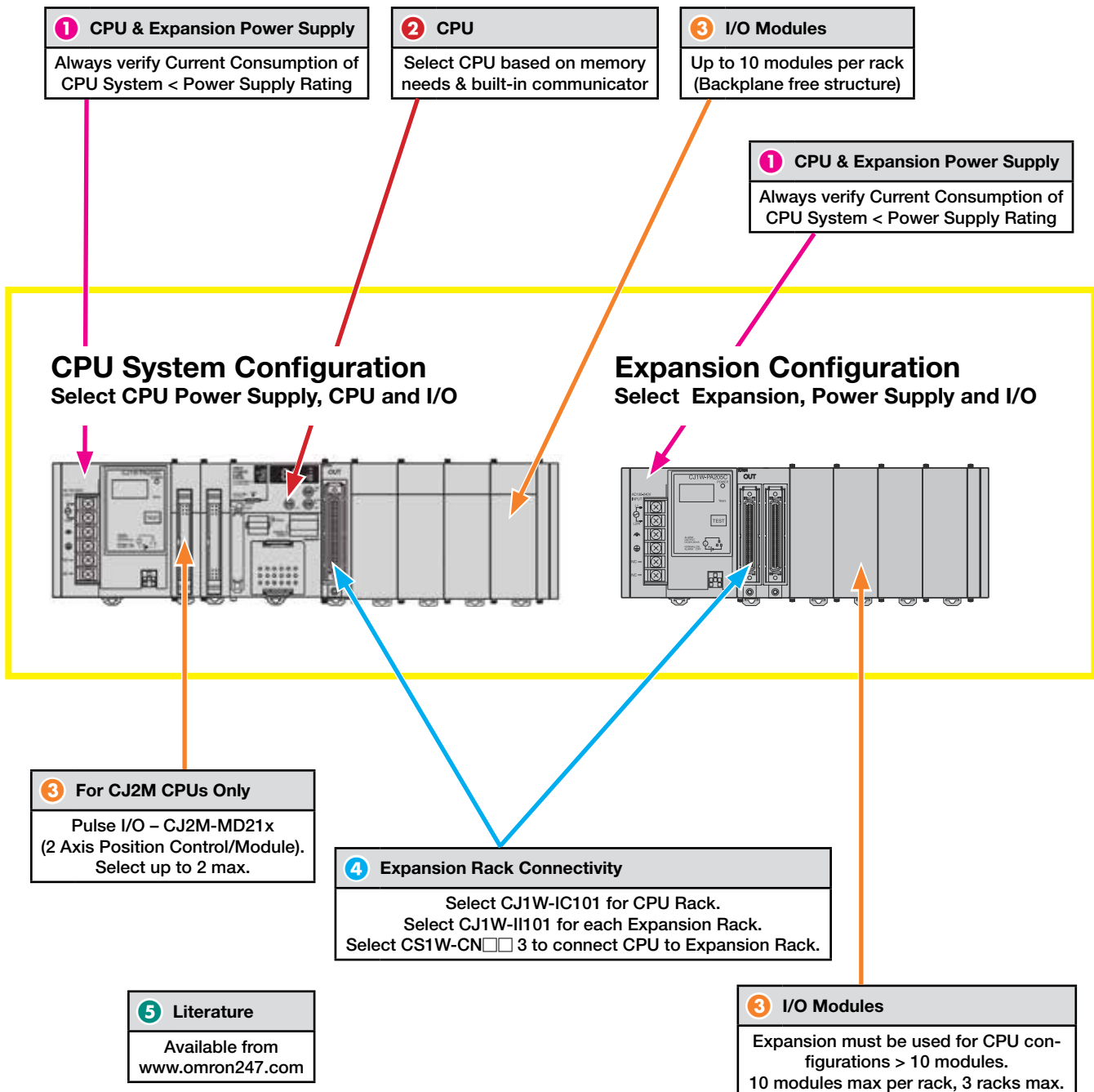

## Ordering Information

### 1 CPU & Expansion Power Supply

Input range	Power consumption	Output capacity at 5 VDC	Output capacity at 24 VDC	Max. output power	Features	Width	Model
21.6 - 25.4 VDC	35 W max.	2.0 A	0.4 A	16.6 W	--	27 mm	CJ1W-PD022
19.2 - 28.8 VDC	50 W max.	5.0 A	0.8 A	25 W	--	60 mm	CJ1W-PD025
85 - 264 VAC 47 - 63 Hz	50 VA max.	2.8 A	0.4 A	14 W	--	45 mm	CJ1W-PA202
	100 VA max	5.0 A	0.8 A	25 W	Run output (SPST relay)	80 mm	CJ1W-PA205R
					Maintenance status display	80 mm	CJ1W-PA205C

Note: The CJ1W-PD022 has no galvanic isolation.

### 2 CPU

Max digital I/O points	Program capacity	Data memory capacity	Logic execution speed	Max. I/O units	Width	5 V Current consumption	Built-in functions	Model
2,560	400 K	832 K	16 ns	40	80 mm	820 mA	USB + Ethernet/IP + RS-232C	CJ2H-CPU68-EIP
	250 K	512 K						CJ2H-CPU67-EIP
	150 K	352 K						CJ2H-CPU66-EIP
	100 K	160 K						CJ2H-CPU65-EIP
	50 K	160 K						CJ2H-CPU64-EIP
	60 K	160 K	40 ns		62 mm	700 mA	USB + Ethernet/IP, serial comm. option slot	CJ2M-CPU35
	30 K	160 K						CJ2M-CPU34
	20 K	64 K						CJ2M-CPU33
	10 K	64 K						CJ2M-CPU32
	5 K	64 K						CJ2M-CPU31
	60 K	160 K			31 mm	500 mA	USB + RS-232C	CJ2M-CPU15
	30 K	160 K						CJ2M-CPU14
	20 K	64 K						CJ2M-CPU13
	10 K	64 K						CJ2M-CPU12
	5 K	64 K						CJ2M-CPU11

## 3 Communication/Networks

Type	Ports	Data transfer	Protocols	Unit class	Width	Connection type	Model
Serial	2 x RS-232C		CompoWay/F, Host link, NT link, Modbus, User-defined	CPU bus unit	31 mm	9-pin D-Sub	CJ1W-SCU21-V1
Serial	2 x RS-232C	High-speed	CompoWay/F, Host link, NT link, Modbus, User-defined	CPU bus unit	31 mm	9-pin D-Sub	CJ1W-SCU22
Serial	2 x RS-422A/RS-485		CompoWay/F, Host link, NT link, Modbus, User-defined	CPU bus unit	31 mm	9-pin D-Sub	CJ1W-SCU31-V1
Serial	2 x RS-422A/RS-485	High-speed	CompoWay/F, Host link, NT link, Modbus, User-defined	CPU bus unit	31 mm	9-pin D-Sub	CJ1W-SCU32
Serial	1 x RS-232C + 1 x RS-422/RS-485		CompoWay/F, Host link, NT link, Modbus, User-defined	CPU bus unit	31 mm	9-pin D-Sub	CJ1W-SCU41-V1
Serial	1 x RS-232C + 1 x RS-422/RS-485	High-speed	CompoWay/F, Host link, NT link, Modbus, User-defined	CPU bus unit	31 mm	9-pin D-Sub	CJ1W-SCU42
Ethernet	1 x 100 Base-Tx		UDP, TCP/IP, FTP server,SMTP (e-mail), SNTP (time adjust), FINS routing, socket service	CPU bus unit	31 mm	RJ45	CJ1W-ETN21
EtherNet/IP	1 x 100 Base-Tx		EtherNet/IP, UDP, TCP/IP, FTP server, SNTP, SNMP	CPU bus unit	31 mm	RJ45	CJ1W-EIP21
DeviceNet	1 x CAN		DeviceNet	CPU bus unit	31 mm	5-p detachable	CJ1W-DRM21
PROFIBUS-DP	1 x RS-485 (Master)		DP, DPV1	CPU bus unit	31 mm	9-pin D-Sub	CJ1W-PRM21
PROFIBUS-DP	1 x RS-485 (Slave)		DP	Special I/O unit	31 mm	9-pin D-Sub	CJ1W-PRT21
PROFINET-IO	1 x 100 Base-Tx		PROFINET-IO Controller, FINS/UDP	CPU bus unit	31 mm	RJ45	CJ1W-PNT21
CAN	1 x CAN		User-defined, supports 11-bit and 29-bit identifiers	CPU bus unit	31 mm	5-p detachable	CJ1W-CORT21
CompoNet	4-wire, data + power to slaves (Master)		CompoNet (CIP-based)	Special I/O unit	31 mm	4-p detachable IDC or screw	CJ1W-CRM21
CompoBus/S	2-wire (Master)		Omron proprietary	Special I/O unit	20 mm	2-wire screw + 2-wire power	CJ1W-SRM21



## 3 Digital I/O

Points	Type	Rated voltage	Rated current	Width	Remarks	Connection type <sup>1</sup>	Model
16	AC input	120 VAC	7 mA	31 mm	--	M3	CJ1W-IA111
8	AC input	240 VAC	10 mA	31 mm	--	M3	CJ1W-IA201
8	DC input	24 VDC	10 mA	31 mm	--	M3	CJ1W-ID201
16	DC input	24 VDC	7 mA	31 mm	--	M3	CJ1W-ID211
16	DC input	24 VDC	7 mA	31 mm	Fast-response (15 μs ON, 90 μs OFF)	M3	CJ1W-ID212
16	DC input	24 VDC	7 mA	31 mm	Inputs start interrupt tasks in PLC program	M3	CJ1W-INT01
16	DC input	24 VDC	7 mA	31 mm	Latches pulses down to 50 μs pulse width	M3	CJ1W-IDP01
32	DC input	24 VDC	4.1 mA	20 mm	--	1 x Fujitsu	CJ1W-ID231
32	DC input	24 VDC	4.1 mA	20 mm	--	1 x MIL <sup>1</sup> (40 pt)	CJ1W-ID232
32	DC input	24 VDC	4.1 mA	20 mm	Fast-response (15 μs ON, 90 μs OFF)	1 x MIL <sup>1</sup> (40 pt)	CJ1W-ID233
64	DC input	24 VDC	4.1 mA	31 mm	--	2 x Fujitsu	CJ1W-ID261
64	DC input	24 VDC	4.1 mA	31 mm	--	2 x MIL <sup>1</sup> (40 pt)	CJ1W-ID262
8	Triac output	250 VAC	0.6 mA	31 mm	--	M3	CJ1W-OA201
8	Relay output	250 VAC	2 A	31 mm	Independent response	M3	CJ1W-OC201
16	Relay output	250 VAC	2 A	31 mm	--	M3	CJ1W-OC211
8	DC output (sink)	12 to 24 VDC	2 A	31 mm	--	M3	CJ1W-OD201
8	DC output (source)	24 VDC	2 A	31 mm	With short-circuit protection, alarm	M3	CJ1W-OD202
16	DC output (sink)	12 to 24 VDC	0.5 A	31 mm	--	M3	CJ1W-OD211
16	DC output (source)	24 VDC	0.5 A	31 mm	With short-circuit protection, alarm	M3	CJ1W-OD212
16	DC output (sink)	24 VDC	0.5 A	31 mm	Fast-response (15 μs ON, 80 μs OFF)	M3	CJ1W-OD213
32	DC output (sink)	12 to 24 VDC	0.5 A	20 mm	--	1 x Fujitsu	CJ1W-OD231
32	DC output (source)	24 VDC	0.3 A	20 mm	With short-circuit protection, alarm	1 x MIL <sup>1</sup> (40 pt)	CJ1W-OD232
32	DC output (sink)	24 VDC	0.5 A	20 mm	Fast-response (15 μs ON, 90 μs OFF)	1 x MIL <sup>1</sup> (40 pt)	CJ1W-OD234
64	DC output (sink)	12 to 24 VDC	0.3 A	31 mm	--	2 x Fujitsu	CJ1W-OD261
64	DC output (source)	24 VDC	0.3 A	31 mm	--	2 x MIL <sup>1</sup> (40 pt)	CJ1W-OD262
16 + 16	DC in+out (source)	24 VDC	0.5 A	31 mm	--	2 x MIL <sup>1</sup> (20 pt)	CJ1W-MD232
32 + 32	DC in+out (sink)	24 VDC	0.3 A	31 mm	--	2 x MIL <sup>1</sup> (40 pt)	CJ1W-MD263
32 + 32	DC in+out (TLL)	5 VDC	35 mA	31 mm	--	2 x MIL <sup>1</sup> (40 pt)	CJ1W-MD563

<sup>1</sup> MIL = connector according to MIL-C-83503 (compatible with DIN 41651/IEC 60603-1).

Note: All digital I/O unit are designated as basic I/O units.

**B**

## 3 Analog I/O

Points	Type	Ranges		Resolution	Accuracy (Note 2)	Conversion time	Remarks	Model
4	Universal analog input	DC voltage, DC current, Thermocouple Pt100/Pt1000, potentiometer		1/256,000	0.05%	60 ms/4 points	All inputs individually isolated, configurable alarms, maintenance functions, user-defined scaling, zero/span adjustment	CJ1W-PH41U
4		0 to 1 to 0 to 0 to 4 to	5 V 5 V 10 V 20 mA 20 mA	V/I: 1/12,000 T/C: 0.1 °C RTD: 0.1 °C	V: 0.3% I: 0.3% T/C: 0.3% RTD: 0.3%	250 ms/4 points	Universal inputs, with zero/span adjustment, configurable alarms, scaling, sensor error detection	CJ1W-AD04U
		T/C: K, J, T, L, R, S, B, Pt100, Pt1000, JPt100						
4	Analog input	0 to 1 to 0 to -10 to 4 to	5 V 5 V 10 V 10 V 20 mA	1/8,000	V: 0.2% I: 0.4%	250 µs/point	Offset/gain adjustment, peak hold, moving average, alarms	CJ1W-AD041-V1
8								CJ1W-AD081-V1
2	Analog output			1/4,000	V: 0.02%	1 ms/point	Offset/gain adjustment, output hold	CJ1W-DA021
4					I: 0.05%			CJ1W-DA041
4 + 2	Analog input + output			1/8,000	In: 0.2% Out: 0.3%	1 ms/point	Offset/gain adjustment, scaling, peak hold, moving average, alarms, output hold	CJ1W-MAD42
4	High-speed input			1/40,000	V: 0.2% I: 0.4%	35 µs/4 points	Direct conversion (CJ2 special instruction)	CJ1W-AD042
4	High-speed output	1 to 0 to -10 to	5 V 10 V 10 V	1/40,000	0.3%	35 µs/4 points	Direct conversion (CJ2 special instruction)	CJ1W-DA042V
8	Voltage output	0 to 0 to -10 to 1 to	5 V 10 V 10 V 5 V	1/8,000	0.3%	250 µs/point	Offset/gain adjustment, output hold	CJ1W-DA08V
8	Current output	4 to	20 mA		0.5%			CJ1W-DA08C
2	Process input	4 to 0 to 0 to -10 to 0 to -5 to 1 to 0 to 1.25 to	20 mA 20 mA mA 10 V 10 V 5 V 5 V 5 V 1.25 V 1.25 V	1/64,000	0.05%	5/ms point	Configurable alarms, maintenance functions, user-defined scaling, zero/span adjustment, square root, totalizer	CJ1W-PDC15

**Notes:**

All Analog I/O units are designated as Special I/O units, except CJ1W-TS561/-TS562, which are Basic I/O units (cannot be used with CP1H).

Accuracy for Voltage and Current Inputs/Outputs as percentage of full scale and typical value at 25°C ambient temperature. Accuracy for Temperature Inputs/Outputs as percentage of process value and typical value at 25°C ambient temperature. (Consult the operation manual for details.)

### 3 In-panel Temperature Controller

Inputs	Input type	Ranges	Resolution	Accuracy (Note 2)	Conversion time	Remarks	Model
2	Thermocouple input	B, E, J, K, L, N, R, S, T, U, WRe5-26, PLII, -100 to 100 mV	1/64,000	0.05%	5 ms/ point	Configurable alarms, (absolute + rate-of-change), peak hold, maintenance functions	CJ1W-PTS15
4		B, J, K, L, R, S, T	0.1°C	0.03% 0.05%	62.5 ms/ point	4 configurable alarm outputs	CJ1W-PTS51
6					40 ms/ point		CJ1W-TS561
2	Resistance thermometer input	Pt50, Pt100, JPt100, Ni508.4	1/64,000	0.05%	5 ms/ point	Configurable alarms (absolute + rate-of-change), peak hold, maintenance functions	CJ1W-PTS16
4		Pt100, JPt100	0.1°C	0.03% 0.05%	62.5 ms/ point	4 configurable alarm outputs	CJ1W-PTS52
6					40 ms/ point		CJ1W-TS562

**Notes:**

All Analog I/O units are designated as Special I/O units, except CJ1W-TS561/-TS562, which are Basic I/O units. (cannot be used with CP1H).

Accuracy for Voltage and Current Inputs/Outputs as percentage of full scale and typical value at 25°C ambient temperature. Accuracy for Temperature Inputs/Outputs as percentage of process value and typical value at 25°C ambient temperature. (Consult the operation manual for details)

### 3 Temperature Control Units

Specifications			Model
No. of loops	Temperature sensor inputs	Control outputs	
4 loops	Thermocouple input (R, S, K, J, T, B, L)	Open collector NPN outputs (pulses)	CJ1W-TC001
4 loops		Open collector PNP outputs (pulses)	CJ1W-TC002
2 lops, heater burnout detection function		Open collector NPN outputs (pulses)	CJ1W-TC003
2 lops, heater burnout detection function		Open collector PNP outputs (pulses)	CJ1W-TC004
4 loops	Platinum resistance thermometer input (JPt100, Pt100)	Open collector NPN outputs (pulses)	CJ1W-TC101
4 loops		Open collector PNP outputs (pulses)	CJ1W-TC102
2 lops, heater burnout detection function		Open collector NPN outputs (pulses)	CJ1W-TC103
2 lops, heater burnout detection function		Open collector PNP outputs (pulses)	CJ1W-TC104



### 3 Pulse I/O for CJ2M Only

Product name	Specifications	Current consumption (A)		Standards	Model
		5 V	24 V		
Pulse I/O Module	Sinking outputs, MIL connector 10 inputs (4 interrupt/quick response inputs, 2 high-speed counter inputs) 6 outputs (2 pulse outputs and 2 PWM outputs)	0.08	---	UC1, N, L, CE	CJ2M-MD211
	Sourcing outputs, MIL connector 10 inputs (4 interrupt/quick response inputs, 2 high-speed counter inputs) 6 outputs (2 pulse outputs, 2 PWM outputs)	0.08	---		CJ2M-MD212

**Note:** Connectors are not provided with Pulse I/O Modules. Purchase the following Connector, an OMRON Cable with Connectors for Connector Terminal Block Conversion Units, or an OMRON Cable with Connectors for Servo Relay Units.

### 4 Expansion Rack Connectivity

Type	Description	Width, length	Model
I/O control unit	Required unit on CPU 'rack' to connect I/O expansions	20 mm	CJ1W-IC101
I/O interface unit	Start unit for each I/O expansion 'rack'. Requires a power supply unit.	31 mm	CJ1W-II101
I/O expansion cable	Connects CJ1W-IC101 or -II101 to the next expansion rack's -II101	0.3 m	CS1W-CN313
		0.7 m	CS1W-CN713
		2.0 m	CS1W-CN223
		3.0 m	CS1W-CN323
		5.0 m	CS1W-CN523
		10 m	CS1W-CN133
		12 m	CS1W-CN133-B2

## Fast and Powerful CPUs for Any Task

The CS1 Series gives you superior control performance and optimal power capacity to handle any application. The Series offers redundant CPUs, diverse I/O selection and wide variety of communication platforms to solve your control needs.



B

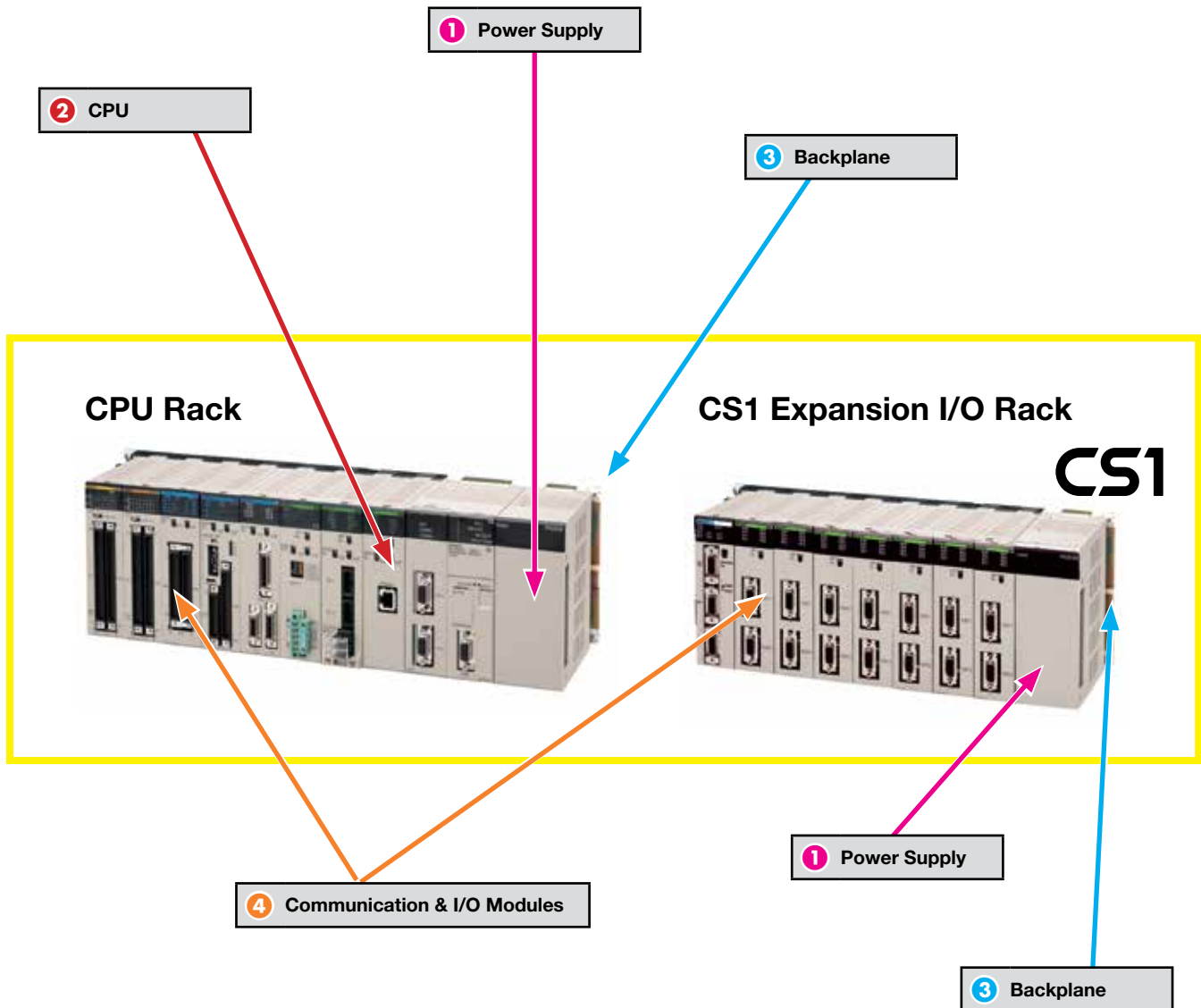

## Ordering Information

### 1 Power Supplies

Input range	Power consumption	Output capacity 5VDC	Output capacity 26 VDC	Max. output power	Extra functions	Model
19.2 to 28.8 VDC	40 W max.	6.6 A	0.62 A	30 W	-	C200HW-PD024
		4.3 A	0.56 A	28 W	Power supply for dual-redundant system	CS1D-PD024
	55 VA max.	5.3 A	1.3 A	40 W	-	C200HW-PD025
					Power supply for dual-redundant system	CS1D-PD025
85 to 264 VAC 50/60 Hz	120 VA max.	4.6 A	0.62 A	30 W	Maintenance status display	C200HW-PA204C
-					C200HW-PA204	
Service output 24 VDC, 0.8 A					C200HW-PA204S	
Run status output (SPST relay)					C200HW-PA204R	
Run status output (SPST relay)					C200HW-PA209R	
85 to 132 VAC, 170 to 264 VAC, 50/60 Hz	180 VA max.	9.0 A	1.3 A	45 W	Run status output (SPST relay)	C200HW-PA209R
	150 VA max.	7.0 A	1.3 A	35 W	Power supply for dual-redundant system	CS1D-PA207R

### 2 CPU

Max. Digital I/O points	Program capacity	Data memory capacity	Logic execution speed	Max. I/O units	Additional functions	Model	
5120	250K steps	448K words	20 ns	80	-	CS1H-CPU67H	
				71	Supports duplex power supply and I/O hot-swapping	CS1D-CPU67S	
				68	CPU for full dual-redundancy	CS1D-CPU67H	
					CPU for full dual-redundancy, with loop control board	CS1D-CPU67P	
	120K steps	256K words		80	-	CS1H-CPU66H	
	60K steps	128K words		80	-	CS1H-CPU65H	
				71	Supports duplex power supply and I/O hot-swapping	CS1D-CPU65S	
					CPU for full dual-redundancy	CS1D-CPU65H	
				CPU for full dual-redundancy, with loop control board	CS1D-CPU65P		
	30K steps	64K words		40 ns	80	-	CS1H-CPU64H
	20K steps					-	CS1H-CPU63H
	60K steps				-	CS1G-CPU45H	
	1280	30K steps			40	-	CS1G-CPU44H
35			Supports duplex power supply and I/O hot-swapping		CS1D-CPU44S		
960	20K steps	30	-		CS1G-CPU43H		
			-		CS1G-CPU42H		
	10K steps	26	Supports duplex power supply and I/O hot-swapping		CS1D-CPU42S		

### 3 Backplanes

Type	Slots	Expansion connector	Width	Special functions	Model
CPU	2	No	200 mm	–	CS1W-BC023
CPU	3	Yes	260 mm	–	CS1W-BC033
CPU	5	Yes	330 mm	–	CS1W-BC053
CPU	8	Yes	435 mm	–	CS1W-BC083
CPU	10	Yes	505 mm	–	CS1W-BC103
Expansion	3	Yes	260 mm	–	CS1W-BI033
Expansion	5	Yes	330 mm	–	CS1W-BI053
Expansion	8	Yes	435 mm	–	CS1W-BI083
Expansion	10	Yes	505 mm	–	CS1W-BI103
CPU	5	Yes	505 mm	For Duplex CPU + Power supplies	CS1D-BC052
CPU	8	Yes	505 mm	For Duplex Power supplies	CS1D-BC082S
Expansion	9	Yes	505 mm	For Duplex Power supplies	CS1D-BI092

### 4 Communication/Networks

Type	Ports	Protocols	Unit class	Connection type	Model
Serial	2 x RS-232C	CompoWay/F, Host Link, NT link, Modbus, User-defined	CPU bus unit	9-pin D-Sub	CS1W-SCU21-V1
Serial	2 x RS-232C/RS-485	CompoWay/F, Host Link, NT link, Modbus, User-defined	CPU bus unit	9-pin D-Sub	CS1W-SCU31-V1
Serial	2 x RS-232C	CompoWay/F, Host Link, NT link, Modbus, User-defined	CPU option board	9-pin D-Sub	CS1W-SCB21-V1
Serial	1 x RS-232C + 1 x RS-422/RS-485	CompoWay/F, Host Link, NT link, Modbus, User-defined	CPU option board	9-pin D-Sub	CS1W-SCB41-V1
GP-IB	Master/Slave selectable	GP-IB instrument communication	Special I/O unit	GP-IB	CS1W-GPI01
Ethernet	1 x 100 Base-Tx	UDP, TCP/IP, FTP server, SMTP (e-mail), SNTP (time adjust), FINS routing, socket service	CPU bus unit	RJ45	CS1W-ETN21
Controller link	2-wire twisted pair	Omron proprietary	CPU bus unit	2-wire screw+GND	CS1W-CLK21-V1
	Optical HPCF			2 x HPCF connector	CS1W-CLK12-V1
	Optical graded-index fiber			4 x ST connector	CS1W-CLK52-V1
EtherNet/IP	1 x 100 Base-Tx	EtherNet/IP, UDP, TCP/IP, FTP server, SNTP, SNMP	CPU Bus unit	RJ45	CS1W-EIP21
DeviceNet	1 x CAN	DeviceNet	CPU bus unit	5-p detachable	CS1W-DRM21-V1
CompoNet	4-wire, data + power to slaves (Master)	CompoNet (CIP-based)	Special I/O unit	4-p detachable IDC or screw	CS1W-CRM21
PROFIBUS-DP	1 x RS-485 (Master)	DP, DPV1	CPU bus unit	9-pin D-Sub	CS1W-PRM21
CAN	1 x CAN	CANopen, User-defined	CPU bus unit	5-p detachable	CS1W-CORT21
PROFIBUS-DP	1 x RS-485 (Slave)	DP	C200H special I/O unit; cannot be used on CS1D systems	9-pin D-Sub	C200HW-PRT21
CompoBus/S	2-wire (Master)	Omron proprietary		2-wire screw + 2-wire power	C200HW-SRM21-V1

## 4 Digital I/O

Points	Type	Rated voltage	Rated current	Remarks	Connection type	Model <sup>1)</sup>
16	AC input	120 VAC	10 mA	--	M3	CS1W-IA111
16	AC input	240 VAC	10 mA	--	M3	CS1W-IA211
16	DC input	24 VDC	7mA	--	M3	CS1W-ID211
16	DC input	24 VDC	7mA	Inputs start interrupt tasks in PLC program	M3	CS1W-INT01
16	DC input	24 VDC	7mA	Latches high speed units	M3	CS1W-IDP01
32	DC input	24 VDC	6mA	--	1 x 40 pt Fujitsu	CS1W-ID231
64	DC input	24 VDC	6mA	--	2 x 40 pt Fujitsu	CS1W-ID261
96	DC input	24 VDC	5mA	--	2 x 56 pt Fujitsu	CS1W-ID291
8	Triac output	250 VAC	1.2 A	--	M3	CS1W-OA201
16	Triac output	250 VAC	0.5 A	--	M3	CS1W-OA211
8	Relay output	250 VAC	2.0 A	--	M3	CS1W-OC201
16	Relay output	250 VAC	2.0 A	--	M3	CS1W-OC211
16	DC output (sink)	12 to 24 VDC	0.5 A	--	M3	CS1W-OD211
16	DC output (source)	24 VDC	0.5 A	With short-circuit protection, alarm	M3	CS1W-OD212
32	DC output (sink)	12 to 24 VDC	0.5 A	--	1 x 40 pt Fujitsu	CS1W-OD231
32	DC output (source)	24 VDC	0.5 A	With short-circuit protection, alarm	1 x 40 pt Fujitsu	CS1W-OD232
64	DC output (sink)	12 to 24 VDC	0.3 A	--	2 x 40 pt Fujitsu	CS1W-OD261
64	DC output (source)	24 VDC	0.3 A	With short-circuit protection, alarm	2 x 40 pt Fujitsu	CS1W-OD262
96	DC output (sink)	12 to 24 VDC	0.1 A	--	2 x 56 pt Fujitsu	CS1W-OD291
96	DC output (source)	24 VDC	0.1 A	--	2 x 56 pt Fujitsu	CS1W-OD292
32+32	DC output (sink)	12 to 24 VDC	0.3 A	--	2 x 40 pt Fujitsu	CS1W-MD261
32+32	DC in+out (source)	24 VDC	0.3 A	With short-circuit protection, alarm	2 x 40 pt Fujitsu	CS1W-MD262
48+48	DC output (sink)	12 to 24 VDC	0.1 A	--	2 x 56 pt Fujitsu	CS1W-MD291
48+48	DC in+out (source)	12 to 24 VDC	0.1 A	--	2 x 56 pt Fujitsu	CS1W-MD292

Note: All Digital I/O units are designated as Basic I/O units.



## 4 Analog I/O

Points	Type	Ranges	Resolution	Accuracy*1	Conversion time	Remarks	Model
4	Analog input	0 to 5 V, 0 to 10 V, -10 to 10 V, 1 to 5 V, 4 to 20 mA	1/8,000	V: 0.2% I: 0.4%	250 μs/point	Offset/gain adjustment, peak hold, moving average, alarms	CS1W- AD041-V1
8				CS1W- AD081-V1			
16				0.2%			CS1W-AD161
4	Analog output	0 to 5 V, 0 to 10 V, -10 to 10 V, 1 to 5 V, 4 to 20 mA	1/4,000	V: 0.3% I: 0.5%	1 ms/point	Offset/gain adjustment	CS1W-DA041
4 + 4	Analog in + output	0 to 5 V, 0 to 10 V, -10 to 10 V, 1 to 5 V (4 to 20 mA input)	1/8,000	V in: 0.2% I in: 0.4% out: 0.3%		Offset/gain adjustment, scaling, peak hold, moving average, alarms, output hold	CS1W- MAD44
8	Voltage output	0 to 5 V, 0 to 10 V, -10 to 10 V, 1 to 5 V	1/4,000	0.3%	1 ms/point	Offset/gain adjustment, output hold	CS1W-DA08V
8	Current output	4 to 20 mA		0.5%			CS1W-DA08C
4	Process input	4 to 20 mA, 0 to 20 mA, 0 to 10 V, -10 to 10 V, 0 to 5 V, -5 to 5 V, 1 to 5 V, 1 to 1.25 V, -1.25 to 1.25 V	1/64,000	0.05%	5 ms/point	Configurable alarms, maintenance functions, user-defined scaling, zero/ span adjustment, square root, totalizer	CS1W-PDC11
8	Process input	-10 to 10 V, 0 to 5 V, 1 to 5 V, 4 to 20 mA	1/16,000	0.3% of PV	62.5 ms/ point	Configurable alarms, zero/ span adjustment, square root	CS1W-PDC55
4	2-Wire transmitter input	1 to 5 V, 4 to 20 mA	1/4,096	0.2%	25 ms/point	Built-in power supply for transmitter, configurable alarms, square root, rate- of-change, etc.	CS1W- PTW01
8	Power transducer input	-1 to 1 mA, 0 to 1 mA -100 to 100 mV, 0 to 100 mV	1/4,096	0.2%	25 ms/point	Inrush current limiter, configurable alarms, averaging, etc.	CS1W-PTR01
			1/4,096	0.2%	25 ms/point		CS1W-PTR02
4	Pulse rate input	20000 pps, voltage, open collector, contact	up to 1/32,000	--	25 ms/point	Averaging, totalizer	CS1W-PPS01

(continued on next page)

## 4 Analog I/O (continued)

Temperature Input Units								
4	Thermocouple input	B, E, J, K, L, N, R, S, T, U, WRe5-26, PLII, -100 to 100 mV	1/64,000	0.05%	5 ms/point	Configurable alarms, (absolute + rate-of-change), peak hold, maintenance functions	CS1W-PTS11	
4		B, J, K, L, R, S, T	0.1°C	0.3%	62.5 ms/point	4 configurable alarm outputs	CS1W-PTS51	
8					31.2 ms/point		CS1W-PTS55	
4	Resistance thermometer input	Pt50, Pt100, JPt100, Ni508.4	1/64,000	0.05%	5 ms/point	Configurable alarms (absolute + rate-of-change), peak hold, maintenance functions	CJ1W-PTS12	
4		Pt100, JPt100	0.1°C	0.3%	62.5 ms/point	4 configurable alarm outputs	CS1W-PTS52	
8					31.2 ms/point		CS1W-PTS56	
Isolated Control Output Units								
4	Isolated control output	1 to 4 to	5 V 20 mA	1/4,000	I: 0.1% V: 0.2%	25 ms/point	Output read back, high/low/rate limiting, disconnection alarm, zero/span adjustment	CS1W-PMV01
4		-10 to 0 to -5 to 0 to -1 to 0 to	10 V 10 V 5 V 5 V 1 V 1 V	1/4,000	0.1%	10 ms/point	High/low/rate limiting, output hold, zero/span adjustment	CS1W-PMV02

### Notes:

Accuracy for Voltage and Current Inputs/Outputs as percentage of full scale and typical value at 25°C ambient temperature.

Accuracy for Temperature Inputs/Outputs as percentage of process value and typical value at 25°C ambient temperature.

(Consult the operation manual for details)

All Analog I/O units are designated as Special I/O units, except CJ1W-TS561/-TS562, which are Basic I/O units.

## Accessories

Description	Remarks	Model
Duplex unit, required for CS1D-CPU6_H systems	-	CS1D-DPL01
Serial communication option board, 2 x RS-232C	-	CS1W-SCB21-V1
Serial communication option board, 1 x RS-232C + 1 x RS422/RS-485	-	CS1W-SCB41-V1
Loop control option board	50 control blocks max.	CS1W-LCB01
Loop control option board	300 control blocks max.	CS1W-LCB05
Replacement battery set, for all CS1 CPUs	-	CS1W-BAT01
CS1 I/O connecting cable	0.3, 0.7, 2, 3, 5, 10, 12 m	CS1W-CN□□□□
Compact Flash memory card, 128 MB, for all models (not required for operation)	Industrial grade flash	HMC-EF183
Compact Flash memory card, 256 MB, for all models (not required for operation)	Industrial grade flash	HMC-EF283
Compact Flash memory card, 512 MB, for all models (not required for operation)	Industrial grade flash	HMC-EF583
Compact Flash PC-Card adapter	-	HMC-AP001

## High Performance Micro PLC

The CP1H series combines the compactness of a micro PLC and the power of a modular PLC. It is ideal for multi-axis positioning control and suitable for simple loop control. The CP1H can be expanded with CP-series I/Os and supports up to two CJ1 special I/O units.



B

## Ordering Information

Built-in functions: E = Encoder inputs; I/C = Interrupts/counters; P = Pulse outputs

Input points	Output points	Expandable up to*	Program capacity	Data memory capacity	Power supply	Output method	Built-in functions			Model
							E	I/C	P	
<b>CP1H-X with pulse outputs for 4 axes</b>										
24	16	320 points	20K steps	32K words	85 to 264 VAC	Relay output	4	8	--	CP1H-X40DR-A
						Transistor output (sink type)	4	8	4	CP1H-X40DT-D
						Transistor output (source type)	4	8	4	CP1H-X40DT1-D
<b>CP1H-XA with built-in analog I/O (4 analog inputs/2 analog outputs; 1/12,000 resolution)</b>										
24	16	320 points	20K steps	32K words	85 to 264 VAC	Relay output	4	8	--	CP1H-XA40DR-A
						Transistor output (sink type)	4	8	4	CP1H-XA40DT-D
						Transistor output (source type)	4	8	4	CP1H-XA40DT1-D
<b>CP1H-Y with 1-MHz pulse I/O</b>										
12	8	300 points	20K steps	32K words	20.4 to 26.4 VDC	Transistor output (sink type)	4**	6	4**	CP1H-Y20DT-D

\*CP1H CPU series can be expanded with CP-series Expansion Units and CJ1 Special I/O Units.

\*\* Encoder inputs: 2x 1 MHz + 2x 100 kHz; Pulse outputs: 2x 1 MHz + 2x 100 kHz.

## The Compact Machine Controller

The CP1L series offers maximum cost effectiveness within a minimal product footprint. It is ideal for stand alone machine position control, temperature control and multi-connection Ethernet applications. The CP1L is selectable from 10 I/O to 60 I/O, with select models featuring built-in Ethernet and analog inputs. Additionally, can be expanded up to 180 I/O using CP-series expansion units offering a variety of I/O, analog and communication options.



## Ordering Information

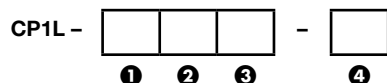

Designator	Description
<b>① Program/Data Capacity/Embedded Communications</b>	
L	5k steps/10k words
M	10k steps/32k words
EL	5k (+10k FB) steps/10k words/Ethernet
EM	10k (+10k FB) steps/32k words/Ethernet
<b>② Digital I/O (Total I/O Capacity)</b>	
10D	6 inputs, 4 outputs (10)
14D	8 inputs, 6 outputs (54)
20D	12 inputs, 8 outputs (60)
30D	18 inputs, 12 outputs (150)
40D	24 inputs, 16 outputs (160)
60D	36 inputs, 24 outputs (180)
<b>③ Output Type</b>	
R	Relay
T	Transistor (sinking)
T1	Transistor (sourcing)
<b>④ Voltage</b>	
A	85 to 264 VAC
D	20.4 to 26.4 VDC

Built-in Functions	Number	Model
Encoder Inputs	4 (100 kHz)	All
Interrupts/Counters	2	-L10D Type
	4	-L14D Type
	6	-20D thru -60D Type
Pulse Outputs	2 (100 kHz)	Transistor Output Type
Analog Inputs	2	-EL & -EM Type

Note: Not all configuration are available. Please refer to the website for a full list of models and complete specifications.

## Easy, Efficient and Economic

The CP1E is an economy class micro PLC that satisfies entry-level requirements for basic applications. Select CPUs from 10 I/O to 60 I/O with basic expandability.



B

## Ordering Information

CP1E -     -   
 ① ② ③ ④ ⑤

Designator	Description
<b>① Program/Data Capacity/Embedded Communications</b>	
E	2k steps/2k words
N	8k steps/8k words, RS-232C
<b>② Analog I/O</b>	
A	2 inputs, 1 output
<b>③ Digital I/O (Total I/O Capacity)</b>	
10D	6 inputs, 4 outputs (10)
14D	8 inputs, 6 outputs (14)
20D	12 inputs, 8 outputs (20, except -NA type: 140)
30D	18 inputs, 12 outputs (150)
40D	24 inputs, 16 outputs (160)
60D	36 inputs, 24 outputs (180)
<b>④ Output Type</b>	
R	Relay
T	Transistor (sinking)
T1	Transistor (sourcing)
<b>⑤ Voltage</b>	
A	100 to 240 VAC
D	24 VDC

Built-in Functions	Number	Model
Pulse Outputs	2 (100 kHz)	Only -N Type Transistor Models
Interrupts/Counters	4	-E10 Type
	6	-E/N14 thru -E/N60 Type

Note: Not all configuration are available. Please refer to the website for a full list of models and complete specifications.

## Expand the Capacity of Your Micro PLC

A wide variety of expansion units that can be used with CP1E, CP1L, and CP1H series PLC.



## Ordering Information

Description	Output type	Input points	Output points	Size in mm (HxWxD)	Model
Expansion I/O units	--	8	--	90x66x50	CP1W-8ED
	Relay	--	8	90x66x50	CP1W-8ER
	Transistor (sinking)	--	8	90x66x50	CP1W-8ET
	Transistor (sourcing)	--	8	90x66x50	CP1W-8ET1
	Relay	--	16	90x86x50	CP1W-16ER
	Relay	12	8	90x96x50	CP1W-20EDR1
	Transistor (sinking)	12	8	90x96x50	CP1W-20EDT
	Transistor (sourcing)	12	8	90x96x50	CP1W-20EDT1
	Relay	24	16	90x150x50	CP1W-40EDR
	Transistor (sinking)	24	16	90x150x50	CP1W-40EDT
	Transistor (sourcing)	24	16	90x150x50	CP1W-40EDT1
Analog I/O units	Analog (resolution 1/256)	2	1	90x66x50	CPM1A-MAD01
	Analog (resolution 1/6000)	2	1	90x86x50	CP1W-MAD11
	Analog (resolution 1/6000)	4	--	90x86x50	CP1W-AD041
	Analog (resolution 1/6000)	--	4	90x86x50	CP1W-DA041
Temperature sensor input units	Thermocouple input	2	--	90x86x50	CP1W-TS001
	Thermocouple input	4	--	90x86x50	CP1W-TS002
	Platinum resistance input	2	--	90x86x50	CP1W-TS101
	Platinum resistance input	4	--	90x86x50	CP1W-TS102

### Options for CPU Units

Name	Specifications	Model
RS-232C Option Board	Can be mounted in either CPU Unit Option Board slot 1 or 2. Note: Cannot be used for the CP1L-L10.	CP1W-CIF01
RS-422A/485 Option Board	Can be mounted in either CPU Unit Option Board slot 1 or 2. Note: Cannot be used for the CP1L-L10. Maximum transmission distance: 50m	CP1W-CIF11
RS-422A/485 Isolated-type Option Board	One RS-422A/485 port (Isolated) Note: Cannot be used for the CP1L-L10. Maximum transmission distance: 500m	CP1W-CIF12
LCD Option Board	Can be mounted only in the CPU Unit Option Board slot 1. Note: Cannot be used for the CP1L-L10.	CP1W-DAM01
Memory Cassette	Can be used for backing up programs or auto-booting	CP1W-ME05M
Economical Ethernet Option Board	Two can be mounted in either of CPU Unit Option Board slot 1 and 2. Note: Cannot be used for the CP1L-L10.	CP1W-ETN61
Advanced Ethernet Option Board	One can be mounted in either CPU Unit Option Board slot 1 or 2. Note: Cannot be used for the CP1E or the CP1L-L10.	CP1W-CIF41
Ethernet/IP Slave Option Board	One can be mounted in either CPU Unit Option Board slot 1 or 2. Note: Cannot be used for the CP1E or the CP1L-L10.	CP1W-EIP61
Modbus/TCP Slave Option Board	One can be mounted in either CPU Unit Option Board slot 1 or 2. Note: Cannot be used for the CP1E or the CP1L-L10.	CP1W-MODTCP61
2 Point Thermocouple Option Board	J/K thermocouple, can be mounted in either CPU Unit Option Board slot 1 or 2. Note: Cannot be used for the CP1E.	CP1W-GCTS2
2 Analog Input Option Board	0-10 V, 0-20 mA Note: Only for the CP1L-E	CP1W-ADB21
2 Analog Output Option Board	0-10 V Note: Only for the CP1L-E	CP1W-DAB21V
2 In/2 Out Analog Option Board	Input: 0-10 V, 0-20 mA, Output: 0-10 V Note: Only for the CP1L-E	CP1W-MAB221

**Easy to Use for Small Scale Control Applications, Offers Precision and Space Savings**



## Ordering Information

Description	Inputs/power supply	Outputs	Analog input/comparators	8-digit counter/comparators	Model		
<b>10-POINT CPU PROGRAMMABLE RELAY UNITS</b>							
10 I/O CPU Expandable up to 34 I/O	6	100 to 240 VAC	4	Relays	—	Yes / 4	ZEN-10C1AR-A-V2
		12 to 24 VDC		Transistors			2 Ch. 0 - 10V / 4
10 I/O CPU Economy model (non-expandable)	6	100 to 240 VAC	4	Relays	—	Yes / 4	ZEN-10C1DT-D-V2
		12 to 24 VDC		Transistors			2 Ch. 0 - 10V / 4
9 I/O CPU with RS-485 Communications Expandable up to 33 I/O	6	100 to 240 VAC	3	Relays	—	Yes / 4	ZEN-10C3DR-D-V2
		12 to 24 VDC		Transistors			2 Ch. 0 - 10V / 4
<b>20-POINT CPU PROGRAMMABLE RELAY UNITS</b>							
20 I/O CPU Expandable up to 44 I/O	12	100 to 240 VAC	8	Relays	—	Yes / 4	ZEN-10C4DR-D-V2
		12 to 24 VDC		Transistors			2 Ch. 0 - 10V / 4
20 I/O CPU Economy model (non-expandable)	12	100 to 240 VAC	8	Relays	—	Yes / 4	ZEN-20C1DR-D-V2
		12 to 24 VDC		Transistors			2 Ch. 0 - 10V / 4
20 I/O CPU Economy model (non-expandable)	12	100 to 240 VAC	8	Relays	—	Yes / 4	ZEN-20C3AR-A-V2
		12 to 24 VDC		Transistors			2 Ch. 0 - 10V / 4
<b>I/O EXPANSION UNITS</b>							
8 I/O Expansion units	4	100 to 240 VAC	4	Relays	—	—	ZEN-8E1AR
				Relays	—	—	ZEN-8E1DR
				Transistors	—	—	ZEN-8E1DT
<b>ZEN ACCESSORIES</b>							
ZEN Support Software					ZEN-SOFT01V4		
ZEN Programming cable - Serial to ZEN (2 m)					ZEN-CIF01		
Memory cassette – Copies program to multiple units					ZEN-ME01		
ZEN Battery – Use with controller CPU to provide 10 years of memory protection to prevent data loss in the event of an extended power outage (45 H x 17.5 W x 44 D mm)					ZEN-BAT01		

## ZEN Starter Kit

The kit includes: 10 I/O CPU, PC programming cable (RS-232 to Zen), Support Software, Manuals and Simulator Switches:

Description	Model
AC I/O Kit with ZEN-10C1AR-A-V2	ZEN-STARTER01-V2
DC I/O Kit with ZEN-10C1DR-D-V2	ZEN-STARTER02-V2



## Contents

Selection Guide		C-ii
<b>Remote I/O</b>		
NX	NX Modular & Safety I/O	C-1
NX-S	NX Safety Control and I/O	C-2
GRT	SmartSlice I/O System	C-3
DRT2	In-panel DeviceNet I/O	C-4
DRT2	On-machine DeviceNet I/O	C-5
CRT1	CompoNet I/O	C-6
ERT1	EtherNet/IP I/O	C-7
GX	EtherCAT Remote I/O	C-8
<b>Remote Terminal Blocks &amp; Cabling</b>		
XW2□	Wire Terminals	C-9
G7TC/ G70A/ G70D	Relay Terminal Blocks	C-11
XS5/XS6	Ethernet Cordsets & Connectors	C-12
GX-JC	EtherCAT Junction Slaves	C-13

## EXPAND YOUR I/O CAPABILITIES

Omron's offering of remote I/O allows you to expand your automation system to fit the needs of your application. Performance and flexibility are key to our remote I/O solutions allowing you to reduce engineering time, reduce machine downtime and increase your efficiency.

Omron's remote I/O offers solutions for a variety of networks including: EtherCAT, EtherNet/IP, DeviceNet, PROFINET, PROFIBUS-DP, and CompoNet. This provides you the flexibility to adapt to local requirements, anywhere in the world.

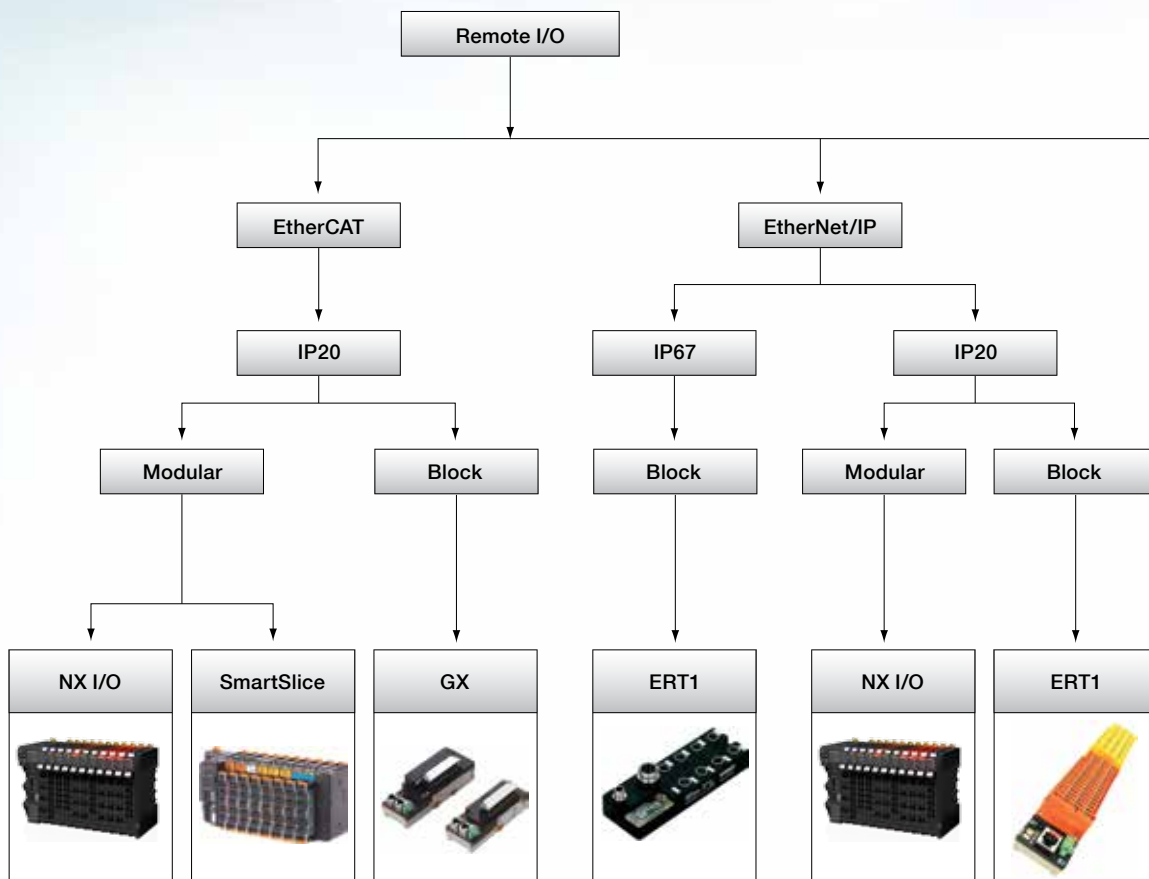

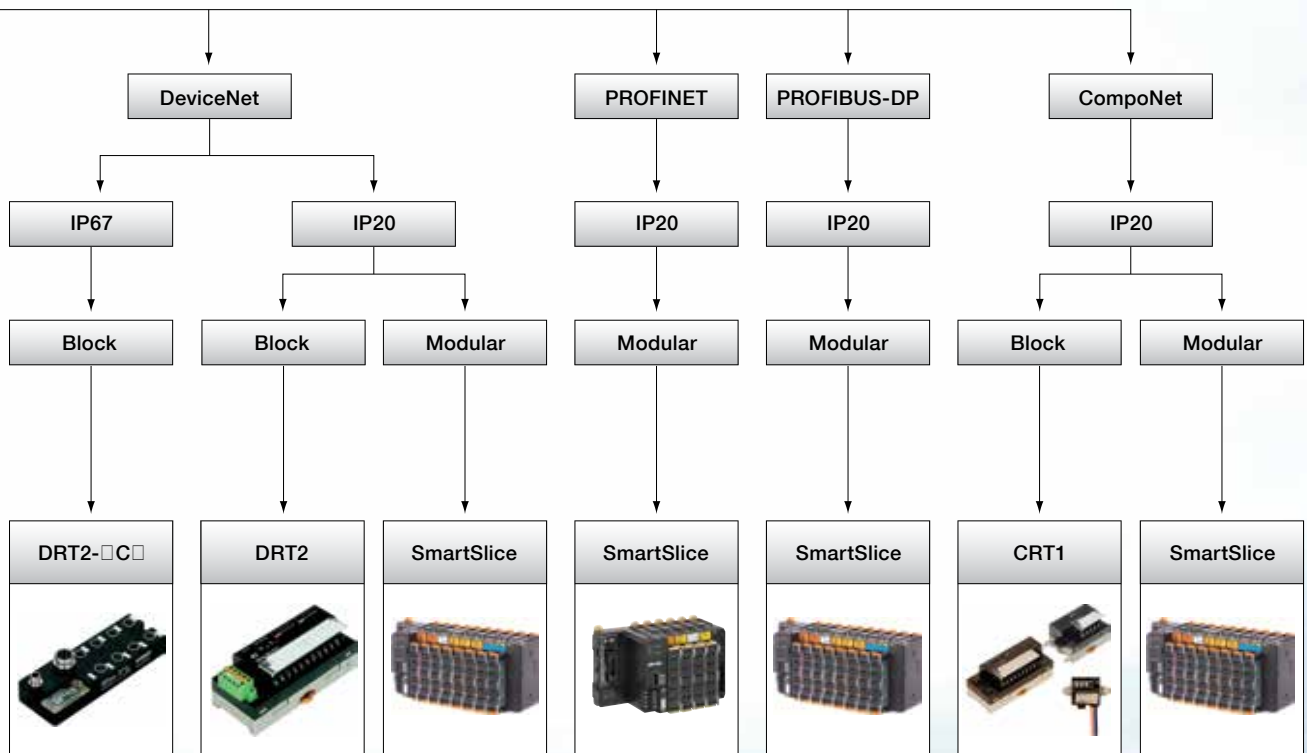





# Selection Table

	Modular I/O		Block I/O
			
Model	NX I/O	GRT-SmartSlice	GX-EtherCAT
Network Connection	EtherCAT, EtherNet/IP, FSOE	DeviceNet open-style terminal block PROFIBUS-DP 9-pin D-sub CompoNet: 4-pin system connector PROFINET-IO: 2x RJ45 MECHATROLINK-II: 2x ML-II, EtherCAT	EtherCAT: RJ45 shielded connector x2 • CN IN: EtherCAT input • CN OUT: EtherCAT output
I/O types	<ul style="list-style-type: none"> <li>• 4/18/16-point digital I/O</li> <li>• 4-point high speed I/O</li> <li>• 2/4/8 point analog input point relay output</li> <li>• 2 point relay output</li> <li>• 2/4 point thermocouple, RTD</li> <li>• 1/2 point encoder: open collector</li> <li>• 1 pt encoder: line receiver</li> <li>• 1/2 point SSI input</li> <li>• 1 point pulse output</li> <li>• Power feed/connection units</li> <li>• Safety controller</li> <li>• 4/8 point safety digital input</li> <li>• 2/4 point safety digital output</li> <li>• 16/32 Point High Density Mil connector</li> </ul>	<ul style="list-style-type: none"> <li>• 2/4/8-point digital I/O</li> <li>• 2-point analog I/O</li> <li>• 2-point temperature input Counter units</li> <li>• Power feed units</li> <li>• Expansion units</li> </ul>	<ul style="list-style-type: none"> <li>• 16 DI, 16 DO, 16 RO, 8DI + 8DO, 32 DI, 32 DO</li> <li>• Expansion units: 8/16 DI, 8/16 DO</li> <li>• 4 Analog In (V/I, TC, Pt100)</li> <li>• 2 Analog Out (V/I)</li> <li>• Encoder: Open collector</li> <li>• Line driver inputs</li> </ul>
I/O Connection technology	Screwless cage clamp, detachable terminal block	Push-in screwless clamp	M3 screw terminals, eCON/RITS sensor connectors
Smart features	<ul style="list-style-type: none"> <li>• Synchronous I/O over EtherCAT</li> <li>• Time stamping</li> <li>• ISO13849-1</li> <li>• Ple</li> <li>• IEC61508</li> <li>• SIL3</li> </ul>	<ul style="list-style-type: none"> <li>• I/O and power supply diagnostics</li> <li>• Operation timers and counters per I/O point</li> <li>• Analog value calculations and alarms</li> </ul>	<ul style="list-style-type: none"> <li>• Automatic I/O allocation at node setting</li> </ul>
IP Rating	IP20 (DIN rail mounting in cabinets)	IP20 (DIN rail mounting in cabinets)	IP20
Size in mm (HxWxD)	<ul style="list-style-type: none"> <li>• Coupler 100 x 46 x 80</li> <li>• Dig/Analog In/Out 100 x 12 x 80</li> <li>• 4Pt Thermo/RTD 100 x 24 x 80</li> <li>• Pulse/Encoder 100 x 12 x 80</li> <li>• NX-EC0142 Encoder 100 x 24 x 80</li> <li>• Safety Controller 100 x 30 x 80</li> <li>• Safety In/Out 100 x 12 x 80</li> </ul>	<ul style="list-style-type: none"> <li>• Bus coupler: 4x58x70</li> <li>• I/O units: 84x15x74</li> </ul>	<ul style="list-style-type: none"> <li>• Main/analog units: 52 x 135 x 57.1</li> <li>• 3-tier units: 52 x 200 x 68.9</li> <li>• e-CON units: 52 x 215 x 68.9</li> <li>• 8/16 pt. expansion: 50 x 66/50 x 94</li> </ul>



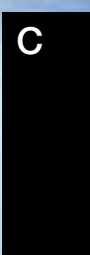

Legend: DI = Digital Input; DO = Digital Output; AI = Analog Input; AO = Analog Output; V/I = Voltage/Current; TC = Temperature Controller; TS = Temperature Sensor Input

	Block I/O			Field I/O
				
Model	<b>ERT1-EtherNet/IP</b>	<b>DRT2-DeviceNet</b>	<b>CRT1-CompoNet</b>	<b>DRT2-DeviceNet</b>
Network Connection	EtherNet/IP IP67 Blocks and open-style with Cage Clamps	DeviceNet with open-style push-in terminal block	Unshielded 4-wire flat cable and IDC connectors, or general-purpose 2-wire cable by screw terminals	DeviceNet with M12 micro connector
I/O types	<ul style="list-style-type: none"> <li>• IP 67: 16 In PNP</li> <li>• IP 67: 16 Out PNP</li> <li>• Cage Clamp: 32 In PNP</li> <li>• Cage Clamp: 32 In PNP</li> <li>• Cage Clamp: 16 In &amp; Out PNP</li> </ul>	<ul style="list-style-type: none"> <li>• 8/16 DI+extension</li> <li>• 8/16 DO+extension</li> <li>• 16 relay out</li> <li>• 4 AI (V/I, TC, Pt100)</li> <li>• 2 AO (V/I)</li> </ul>	<ul style="list-style-type: none"> <li>• 16 DI+extension</li> <li>• 16 DO+extension</li> <li>• 4 AI</li> <li>• 2 AO</li> <li>• 2 DI</li> <li>• 2 DO</li> <li>• 4 TS</li> </ul>	<ul style="list-style-type: none"> <li>• 8/16DI</li> <li>• 8/16DO</li> <li>• 8DI+8DO</li> </ul>
I/O Connection technology	M12 micro connector or Cage Clamp	M3 screw terminals (1 or 3-wire DI)	M3 screw terminals, eCON/RITS sensor connectors	<ul style="list-style-type: none"> <li>• M12, 1 or 2 I/O signals per connector</li> <li>• 7/8" I/O Power connector</li> </ul>
Smart features	<ul style="list-style-type: none"> <li>• I/O isolation</li> <li>• Status indication</li> <li>• Auto Baud Rate Detection</li> <li>• Input Filter</li> </ul>	<ul style="list-style-type: none"> <li>• I/O and power supply diagnostics</li> <li>• Operation timers and counters per I/O point</li> <li>• Analog value calculations and alarms</li> </ul>	<ul style="list-style-type: none"> <li>• I/O and power supply diagnostics</li> <li>• Operation timers and counters per I/O point</li> <li>• Analog value calculations and alarms</li> </ul>	<ul style="list-style-type: none"> <li>• I/O and power supply diagnostics.</li> <li>• Operation timers and counters per I/O point</li> </ul>
IP Rating	<ul style="list-style-type: none"> <li>• IP20 (DIN rail mounting in cabinets)</li> <li>• IP67, flat mount 2 - M5 screws</li> </ul>	IP20 (DIN rail mounting in cabinets)	IP20 (DIN rail mounting in cabinets)	IP67, flat mounting by two M5 screws
Size in mm (HxWxD)	<ul style="list-style-type: none"> <li>• IP67: 60 x 175 x 65mm</li> <li>• Cage Clamp: 57 x 245 x 57mm</li> </ul>	<ul style="list-style-type: none"> <li>• Main units: 50x115/125x50</li> <li>• 8/16 pt. expansion: 50 x 66/50 x 94</li> </ul>	<ul style="list-style-type: none"> <li>• Main units: 50x115x50;</li> <li>• 8/16 pt. expansion: 66 x 50/94 x 50</li> <li>• 2-point slaves: 50x50x30</li> </ul>	175 x 60 x 27.3

Legend: DI = Digital Input; DO = Digital Output; AI = Analog Input; AO = Analog Output; V/I = Voltage/Current; TC = Temperature Controller; TS = Temperature Sensor Input

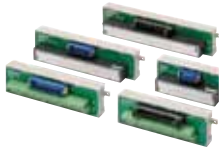

# Remote Terminal Blocks & Cabling

Wire Terminals					
					
Model	XW2B	XW2D	XW2C	XW2E	XW2R
Type	Input/output	Input/output	Input	Input	Input/output
Contacts	20, 34, 40, 60 with flat cable connector 20, 34, 50 contacts, multipole square connector 40 contacts, twin connectors 20 contacts, daisy-chain connection 40 contacts, PCB I/O connector	20, 34, 40, 50 with flat cable connector	16 inputs points, NPN	16 input points	20, 34, 40, 50, 60 with flat cable connector
Cables	XW2Z-F or G79-A_C	XW2Z-A, -AU,-B, -BU	XW2Z-A or XW2Z-D	XW2Z-A	XW2Z

Relay I/O Blocks and Bases				
				
Model	G7TC	P7TF	G70A	G70D
Type	Relay blocks	Relay bases	Relay bases	Relay output terminal
Relays	G7T relays installed	G7T relays or G3R SSRs ordered separately	G2R relays or G3R SSRs ordered separately	G6D relays or G3DZ power MOSFET relays installed
Inputs	16	16	16	-
Input type	NPN, 1 A at 24 VDC NPN, 1 A at 110/120 VAC NPN, 1 A at 220/240 VAC	NPN, 1 A at 24 VDC NPN, 1 A at 110/120 VAC	NPN/PNP, 0.1 A at 5-24VDC	-
Input current	10 mA/point AC or DC	10 mA/point AC or DC	100 mA at 240 VAC/110 VDC	-
Outputs	8 or 16	8 or 16	16	16
Output type	NPN, 5 A at 12 VDC NPN, 5 A at 24 VDC PNP, 5 A at 24 VDC -	5 A/2 A at 12 VDC 5 A/2 A/1 A at 24 VDC PNP, 5 A/2 A/1 A at 24 VDC -	NPN, 10 A/2 A/ 1.5 A at 24 VDC PNP, 10 A/2 A/1.5 A at 24 VDC -	NPN, 5 A at 24 VDC PNP, 5 A at 24 VDC NPN, 0.3 A at 24 VDC PNP, 0.3 A at 24 VDC
Output current	10 A at 250 VAC/30 VDC	10 A at 250 VAC/30 VDC	10 A at 380 VAC/125 VDC	5 A max. with 8 points ON
Cables	G79 series	G79 series	G79 series	G79 series

## Speed and Accuracy for Machine Performance

The NX I/O system offers a wide variety of I/O devices. Its ultra-fast internal bus system is synchronized with the Distributed Clock of the EtherCAT network. The resulting system-wide deterministic I/O operation allows machine builders to improve machine production rates and output quality.

NX-series I/O covers a full range of units, including standard and high-speed digital I/O's, various performance levels in analog I/O, encoder inputs and pulse outputs.

- Over 100 models of I/O units including position control, temperature inputs and integrated safety
- High-speed I/O units synchronised with the EtherCAT cycle
- The NX I/O technology provides deterministic I/O response with nanosecond resolution



EtherCAT® EtherNet/IP®

- Automatic backup/restore of all I/O unit parameters
- Detachable front connector with push-in type screw-less terminals in all NX I/O units
- Slim design: up to 16 I/O points in just 12 mm width

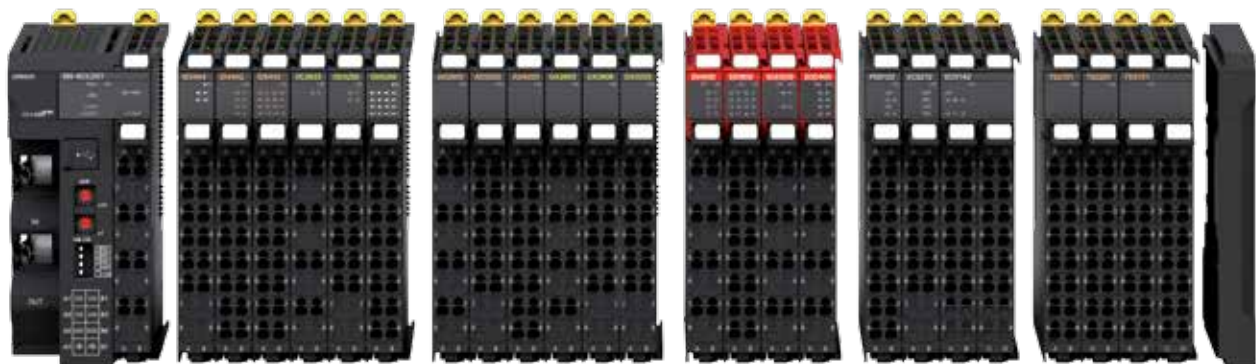

### EtherCAT coupler

- Up to 1024 byte input/1024 byte output
- Automatic backup/restore of all I/O unit parameters. Except Safety Control unit and Safety I/O units

### EtherNet/IP

- Connect CJ CS or Logix controllers over EtherNet/IP
- Up to 63 units per coupler

### Digital I/O

- Units for 4, 8 or 16 points
- Standard, high-speed and time-stamp models
- 16/32 point high density

### Analog I/O

- $\pm 10V$  voltage and 4-20 mA current signals
- 2, 4 or 8 channels per input unit

### Safety I/O

- Up to 8 safety input points per unit
- Freely allocation of the Safety I/O units on the internal high speed bus

### Positioning interface\*

- Encoder input units for connection of external axes to the Sysmac system
- Incremental and absolute encoder support
- Positioning control unit with pulse train output

### Temperature inputs

- Thermocouple or RTD inputs, 2 or 4 per unit

### End Cover

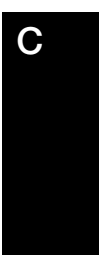

\* Excludes EtherNet/IP coupler

# NX-S Safety Control Unit

## Modular Safety CPU and I/O

Quick Link

H253

omron247.com

### Integration of Safety into Machine Automation Enables Simple, Flexible System Configuration

- EN ISO13849-1 (PLe/Safety Category4), IEC 61508 (SIL3) certified.
- One connection using Safety over EtherCAT (FSoE) \*\* protocol enables flexible configuration by mixing the Safety Units with standard NX I/O.
- Hardware and safety circuits can be configured using the Sysmac Studio (Ver. 1.07)



### Features

- Integrated safety into machine automation possible by connecting with the NX-series EtherCAT Coupler.
- The Safety CPU Unit controls up to 32 Safety I/O Units.
- 4 or 8 points per Safety Input Unit. The 4-point Safety Input Unit can be directly connected with OMRON Non-contact Switches and Single beam Sensors.
- 2 or 4 points per Safety Output Unit. The 2-point Safety Output Unit is characterized by large output breaking current of 2.0 A.
- The Safety Units can be freely allocated in any combination with standard NX I/O.
- Compliant with IEC61131-3
- Safety programs can be standardized and reused efficiently by using POU's for design and operation.

### Ordering Information

Unit type	Max. number of safety I/O points	Program capacity	Number of safety master connections	I/O refreshing method	Model
Safety CPU Unit	256 points	512 KB	32	Free-Run refreshing	NX-SL3300

Unit type	Number of safety input points	Number of test output points	Internal I/O common	Rated input voltage	OMRON special safety input devices	Number of safety slave connections	I/O refreshing method	Model
Safety Input Units	4 points	2 points	Sinking inputs (PNP)	24 VDC	Can be connected*	1	Free-Run refreshing	NX-SIH400
	8 points							NX-SID800

Unit type	Number of safety input points	Internal I/O common	Max load current	Rated voltage	Number of safety slave connections	I/O refreshing method	Model
Safety Output Units	2 points	Sourcing outputs (PNP)	2.0 A/point, 4.0 A/Unit at 40°C, and 2.5 A/Unit at 55°C*	24 VDC	1	Free-Run refreshing	NX-SOH200
	4 points		0.5 A/point and 2.0 A/unit				NX-SOD400

\*The maximum load current depends on the installation orientation and ambient temperatures.

\*\*Safety over EtherCAT (FSoE): The open protocol Safety over EtherCAT (abbreviated with FSoE "FailSafe over EtherCAT") defines a safety related communication layer for EtherCAT. Safety over EtherCAT meets the requirements of IEC 61508 SIL 3 and enables the transfer of safe and standard information on the same communication system without limitations with regard to transfer speed and cycle time.



## Modular I/O System

Omron's SmartSlice I/O system is compact, intelligent and easy. Preventive maintenance data can be accessed using CX-Integrator software, standard PLC function blocks or NS-series Smart Active Parts.



- Easy set-up, backup and restore functions
- Detachable terminal blocks allow hot-swapping without rewiring
- 3-wire connection with 'push-in' technology, no screwdriver required for installation

## Ordering Information

Model	Function	Specifications	Model
Interface Units	DeviceNet interface unit	For up to 64 I/O units	GRT1-DRT
	CompoNet interface unit	For up to 64 I/O units (limited to 32 byte in + 32 byte out)	GRT1-CRT
	PROFIBUS-DP interface unit	For up to 64 I/O units	GRT1-PRT
	PROFINET-IO interface unit	For up to 64 I/O units	GRT1-PNT
	MECHATROLINK-II interface unit	For up to 64 I/O units (slave to Trajexia motion controller)	GRT1-ML2
	EtherCAT interface unit	Up to 64 units for Trajexia and Sysmac NJ	GRT1-ECT*
	End plate	One unit required per bus interface	GRT1-END
	End plate with memory function	Supports tool-less replacement of PROFINET-IO interface unit	GRT1-END-M
I/O units	4 NPN inputs	24 VDC, 6 mA, 3-wire connection	GRT1-ID4
	4 PNP inputs	24 VDC, 6 mA, 3-wire connection	GRT1-ID4-1
	8 NPN inputs	24 VDC, 4 mA, 1-wire connection + 4xG	GRT1-ID8
	8 PNP inputs	24 VDC, 4 mA, 1-wire connection + 4xV	GRT1-ID8-1
	4 AC inputs	110 VAC, 2-wire connection	GRT1-IA4-1
	4 AC inputs	230 VAC, 2-wire connection	GRT1-IA4-2
	4 NPN outputs	24 VDC, 500 mA, 2-wire connection	GRT1-OD4
	4 PNP outputs	24 VDC, 500 mA, 2-wire connection	GRT1-OD4-1
	4 NPN outputs	24 VDC, 500 mA, 3-wire connection	GRT1-OD4G-3
	8 PNP outputs	24 VDC, 2 A, 2-wire connection	GRT1-OD8
	8 PNP outputs	24 VDC, 500 mA, 1-wire connection	GRT1-OD8-1
	8 PNP outputs with short-circuit protections	24 VDC, 500 mA, 1-wire connection	GRT1-OD8G-1
	2 Relay outputs	240 VAC, 2A, normally-open contacts	GRT1-ROS2
	60 kHz Counter unit, NPN	A+B encoder inputs + 1 Z/control input + 1 output (NPN-type)	GRT1-CT1
	60 kHz Counter unit, PNP	A+B encoder inputs + 1 Z/control input + 1 output (PNP-type)	GRT1-CT1-1
	100 kHz Counter / Positioner unit	A+B+Z encoder inputs (line driver or 24 V selectable) + 1 control input + 2 outputs (PNP-type)	GRT1-CP1-L
	2 analog inputs, current/voltage	±10 V, 0-10 V, 0-5 V, 1-5 V, 0-20 mA, 4-20 mA	GRT1-AD2
	2 analog inputs	±10 V, 0-10 V, 0-5 V, 1-5 V	GRT1-DA2V
	2 analog outputs, voltage	0-20 mA, 4-20 mA	GRT1-DAZC
	2 Pt100 inputs	Pt100, 2-wire or 3-wire connection	GRT1-TS2P
2 Pt1000 inputs	Pt1000, 2-wire or 3-wire connection	GRT1-TS2PK	
2 Thermocouple inputs	Types B, E, J, K, N, R, S, T, U, W, PL2, with cold junction compensation	GRT1-TS2T	

Notes: \* GRT1-ECT version 2.0 or higher is required when using Sysmac NJ.

Sysmac NJ does support counter units GRT1-CT1, GRT1-CT1-1, GRT1-CP1-L in GRT1-ECT version 2.1 or higher.

## Compact DeviceNet I/O Units with Extensive Diagnostic Functions

Data regarding power supply status, I/O response times, operation counters and on-time are continuously recorded and checked against user-defined limits.

- Compact, IP20 housing
- Expandable digital I/Os
- Detachable I/O terminal blocks

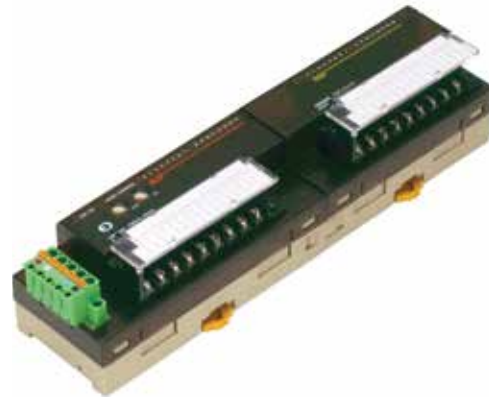

## Ordering Information

Unit type	Specifications	Remarks	Model
8-point PNP input unit (NPN)	24 VDC, 6 mA per point	-	DRT2-ID08-1 (DRT2-ID08)
16-point PNP input unit (NPN)	24 VDC, 6 mA per point	Expandable with one XWT unit	DRT2-ID16-1 (DRT2-ID016)
16-point PNP input unit (NPN)	24 VDC, 6 mA per point	3-tier connection for direct sensor wiring	DRT2-1D16TA-1 (DRT2-ID16TA)
8-point PNP output unit (NPN)	24 VDC, 0.5 A per point	-	DRT2-0D08-1 (DRT2-0D08)
16-point PNP output unit (NPN)	24 VDC, 0.5 A per point	Expandable with one XWT unit	DRT2-0D16-1 (DRT2-0D16)
16-point PNP output unit (NPN)	24 VDC, 0.5 A per point	3-tier connection for direct actuator wiring	DRT2-0D16TA-1 (DRT2-0D16TA)
16-point relay output unit	2 A per point, max. 8 A per common	With easy-to-replace relays, expandable with one XWT unit	DRT2-R0S16
8-input/8-output PNP (NPN)	24 VDC, input 6 mA, output 0.5 A per point	-	DRT2-MD16-1 (DRT2-MD16)
8-input/8-output PNP (NPN)	24 VDC, input 6 mA, output 0.5 A per point	3-tier connection for direct sensor/actuator wiring	DRT2-MD16TA-1 (DRT2-MD16TA)
4-Channel analog input unit	0 to 5 V, 1 to 5 V, 0 to 10 V, -10 to 10 V, 0 to 20 mA, 4 to 20 mA	Resolution 1/6000, conversion time 4 ms (4 inputs)	DRT2-AD04
4-Channel analog output unit	0 to 5 V, 1 to 5 V, 0 to 10 V, -10 to 10 V, 0 to 20 mA, 4 to 20 mA	Resolution 1/30000, conversion time 250 ms (4 inputs)	DRT2-AD04H
2-Channel analog unit	0 to 5 V, 1 to 5 V, 0 to 10 V, -10 to 10 V, 0 to 20 mA, 4 to 20 mA	Resolution 1/6000, conversion time 2 ms (2 outputs)	DRT2-DA02
4-Channel temperature	Platinum Resistance Thermometer types Pt100, JPt100	0.3% accuracy, conversion time 250 ms (4 inputs)	DRT2-TS04P
4-Channel temperature	Thermocouple types R, S, K, J, T, B, L, E, U, N, W and PL2	0.3% accuracy, conversion time 250 ms (4 inputs)	DRT2-TS04T
8-point PNP input expansion unit (NPN)	24 VDC, 6 mA per point	Expansion unit for DRT2 and CRT1 series	XWT-ID08-1 (XWT-ID08)
16-point PNP input expansion unit (NPN)	24 VDC, 6 mA per point	Expansion unit for DRT2 and CRT1 series	XWT-ID16-1 (XWT-ID16)
8-point PNP output expansion unit (NPN)	24 VDC, 0.5 mA per point	Expansion unit for DRT2 and CRT1 series	XWT-0D08-1 (XWT-0D08)
16-point PNP output expansion unit (NPN)	24 VDC, 0.5 mA per point	Expansion unit for DRT2 and CRT1 series	XWT-0D16-1 (XWT-0D16)

## DeviceNet I/O for Harsh Environments—Rugged I/O units for field mounting

The DRT2 slave units feature internal diagnostic and maintenance data collection, which can be accessed over the network. Power supply status, I/O response times, operation counters and on-time monitor data is available at all times, and is internally checked against user-defined limits. Maintenance warnings will be generated when limits are exceeded. Using CX-One or NS-Series HMI with Smart Active Parts for visualization, this allows more efficient system setup, commissioning and troubleshooting without any additional programming. A DeviceNet master is required when using DeviceNet I/O.

- IP67 protection, DRT2 versions are also oil- and welding-splatter proof



- M12 connectors for fast installation
- Internal circuits powered by DeviceNet; fewer connections mean less installation errors
- Smart Slave functions for diagnostics and preventive maintenance
- Indication of broken wire and short-circuit in I/O signals

## Ordering Information

Unit type	Specifications	Remarks	Model
4-point PNP input unit (NPN)	24 V, 6 mA	Separate I/O power supply connection	DRT2-ID04CL-1 (DRT2-ID04CL)
8-point PNP input unit (NPN)	24 V, 6 mA	Separate I/O power supply connection	DRT2-ID08CL-1 (DRT2-ID08CL)
8-point PNP input unit (NPN)	24 V, 11 mA, with power short-circuit and sensor disconnection detection	Unit power supply via DeviceNet cable	DRT2-ID08C-1 (DRT2-ID08C)
16-point PNP input unit (NPN)	24 V, 6 mA, 2 inputs per M12 connector	Separate I/O power supply connection	DRT2-HD16CL-1 (DRT2-HD16CL)
16-point PNP input unit (NPN)	24 V, 11 mA, 2 inputs per M12 connector, with power short-circuit and sensor disconnection detection	Unit power supply via DeviceNet cable	DRT2-HD16C-1 (DRT2-HD16C)
4-point PNP output unit (NPN)	24 V, 0.5 A per point	Separate I/O power supply connection	DRT2-OD04CL-1 (DRT2-OD04CL)
8-point PNP output unit (NPN)	24 V, 0.5 A per point	Separate I/O power supply connection	DRT2-OD08CL-1 (DRT2-OD08CL)
8-point PNP output unit (NPN)	24 V, 1.5 A per point (8 A total), with short-circuit protection + indication	Separate I/O power supply connection	DRT2-OD08C-1 (DRT2-OD08C)
16-point PNP output unit (NPN)	24 V, 0.5 A per point, 2 points per M12 connector	Separate I/O power supply connection	DRT2-WD16CL-1 (DRT2-WD16CL)
8-point input + 8-point PNP output unit (NPN)	24 V, 6 mA input, 0.5 A output per point, 2 points per M12 connector	Separate I/O power supply connection	DRT2-MD16CL-1 (DRT2-MD16CL)

Note: To order NPN (sinking) I/O, omit the "-1" from the end of the model code.

## Smart CompoNet I/O

CompoNet is an open network managed by ODVA and is ideal for high-speed machine control. The special flat cable and IDC connectors make installation quick and easy. The use of repeaters allows wide-area networks with free topology, ideal for conveyor and warehouse automation.



## Ordering Information

Unit type	Specifications	Remarks	Model
2-point PNP input unit (NPN)	24 VDC, 6 mA per point	Power supply via CompoNet cable (50 cm attached)	CRT1B-ID02S-1 (CRT1B-ID02S)
8-point PNP input unit (NPN)	24 VDC, 6 mA per point	Screw terminals, common Power terminals per 8 points	CRT1-ID08-1 (CRT1-ID08)
8-point PNP input unit (NPN)	24 VDC, 6 mA per point	3 push-in terminals per I/O point (signal + power)	CRT1-ID08SL-1 (CRT1-ID08SL)
16-point PNP input unit (NPN)	24 VDC, 6 mA per point	Expandable with one XWT unit	CRT1-ID16-1 (CRT1-ID16-1)
16-point PNP input unit (NPN)	24 VDC, 6 mA per point	3 terminals per I/O point (for power distribution)	CRT1-ID16TA-1 (CRT1-ID16TA)
2-point PNP output unit (NPN)	24 VDC, 0.2 A per point	Power supply via CompoNet cable (50 cm attached)	CRT1B-OD02S-1 (CRT1B-OD02S)
8-point PNP output unit (NPN)	24 VDC, 0.5 A per point	Screw terminals, common Power terminals per 8 points	CRT1-OD08-1 (CRT1-OD08)
8-point PNP output unit (NPN)	24 VDC, 0.5 A per point	3 push-in terminals per I/O point (signal + power)	CRT1-OD08SL-1 (CRT1-OD08SL)
16-point PNP output unit (NPN)	24 VDC, 0.5 A per point	Expandable with one XWT unit	CRT1-OD16-1 (CRT1-OD16)
16-point PNP output unit (NPN)	24 VDC, 0.5 A per point	3 terminals per I/O point (for power distribution)	CRT1-OD16TA-1 (CRT1-OD16TA)
8-point SSR output unit	265 VAC, 0.3 A per point	Screw terminals, common power terminals per 8 points	CRT1-ROF08
8-point relay output unit	250 VAC, 2 A per point, 8 A per common	Screw terminals, common power terminals per 8 points	CRT1-ROS08
16-point relay output unit	250 VAC, 2 A per point, 8 A per common	8 outputs per common	CRT1-ROS16
8-point input + 8-point output unit, PNP (NPN)	24 VDC, 0.5 A per point	Screw terminals, common power terminals	CRT1-MD16-1 (CRT1-MD16)
8-point input + 8-point output unit, PNP (NPN)	24 VDC, 0.5 A per point	3 push-in terminals per I/O point (signal + power)	CRT1-MD16SL-1 (CRT1-MD16SL)
8-point input + 8-point output unit, PNP (NPN)	24 VDC, 0.5 A per point	3 terminals per I/O point (for power distribution)	CRT1-MD16TA-1 (CRT1-MD16TA)
4-Channel analog input unit	0 to 5 V, 1 to 5 V, 0 to 10 V, -10 to 10 V, 0 to 20 mA, 4 to 20 mA	Resolution 1/6000, conversion time 4 ms (4 inputs)	CRT1-AD04
2-Channel analog output unit		Resolution 1/6000, conversion time 2 ms (2 outputs)	CRT1-DA02
4-Channel Temperature	Platinum Resistance Thermometer type Pt100	0.3% accuracy, conversion time 250 ms (4 inputs)	CRT1-TS04P
4-Channel Temperature	Thermocouple types R, S, K, J, T, B, L, E, U, N, W and PL2	0.3% accuracy, conversion time 250 ms (4 inputs)	CRT1-TS04T



## Compact EtherNet/IP Slave I/O

Omron offers two EtherNet/IP I/O families to support this open, Industrial Ethernet network IP67 blocks for on-machine mounting and cage clamp terminal blocks for easy and secure wiring. Built-in, field condition monitoring on all I/O blocks supports diagnostics for reduced-downtime. An EtherNet/IP controller is required when using EtherNet/IP I/O.



- Cage clamp terminals come in a 32-point high-density package for low cost-per-point I/O
- IP67 waterproof models eliminate separate power supply wiring for internal circuits and input devices
- Automatically collects diagnostic data to reduce downtime
- Programmable via front or DIP switches on back

## EtherNet/IP Slaves

Unit type	Appearance	Specifications	Remarks	Connection type	Model
General purpose EtherNet/IP slaves with transistor I/O		32 input points (PNP)	With detection function	Cage clamp terminals	ERT1-ID32SLH-1
		16 input points/ 16 output points (PNP)			ERT1-MD32SLH-1
		32 output points (PNP)			ERT1-OD32SLH-1
Environment resistant EtherNet/IP slaves		16 input points (PNP)	Waterproof, oil-proof, and spatter-proof construction (IP67).  With detection function	Sockets for M12 micro connector (connector that locks easily with 1/8 of a turn)	ERT1-HD16CH-1
		16 output points (PNP)			ERT1-WD16CH-1



## Compact, High-performance Remote I/O

EtherCAT is a high-performance field network able to connect drive devices, intelligent sensors and I/O devices using Ethernet technologies.

- Designed for ultra high-speed applications and response
- Real-time control synchronizes performance between slaves at 1µs max
- Built-in 2-port Ethernet switch reduces costs by allowing easy connection to multiple blocks
- EtherCAT master/slaves connect with standard Ethernet cable



## EtherCAT Remote I/O Terminals

Unit Type	Specifications	I/O type	Remarks	Model
Digital I/O Terminal 2-tier Terminal Block Type	16 input points	NPN	6.0 mA max./input (24 VDC)	GX-ID1611
		PNP		GX-ID1621
	16 output points	NPN	0.5 A/output, 4.0 A/common	GX-OD1611
		PNP		GX-OD1621
	16 output points	Relay	2 A @ 250 VAC/30 VDC	GX-OC1601
	8 input points/ 8 output points	NPN	6.0 mA max./input (24 VDC); 0.5 A/output, 2.0 A/common	GX-MD1611
		PNP		GX-MD1621
	Expansion Units for 2-tier blocks	8 DC input points	NPN	6.0 mA max./input (24 VDC)
PNP			XWT-ID08-1	
8 transistor output points		NPN	0.5 A/output, 2.0 A/common	XWT-OD08
		PNP		XWT-OD08-1
16 DC input points		NPN	6.0 mA max./input (24 VDC)	XWT-ID16
		PNP		XWT-ID16-1
16 transistor output points		NPN	0.5 A/output, 4.0 A/common	XWT-OD16
		PNP		XWT-OD16-1
Digital I/O Terminal 3-tier Terminal Block Type	16 input points	NPN	6.0 mA max./ input (24 VDC)	GX-ID1612
		PNP		GX-ID1622
	16 output points	NPN	0.5 A/output, 4.0 A/common	GX-OD1612
		PNP		GX-OD1622
	8 input points/ 8 output points	NPN	6.0 mA max./ input (24 VDC); 0.5 A/output, 2.0 A/common	GX-MD1612
		PNP		GX-MD1622
Analog I/O Terminal 2-tier Terminal Block Type	4 analog input points	0 to 5V, 1 to 5V, 0 to 10V, -10 to +10V 4 to 20mA	500 µs/input conversion cycle; 1/8000 resolution	GX-AD0471
	2 analog output points			GX-DA0271
Encoder Input Terminal 3-tier Terminal Block Type	2 open collector inputs	NPN	Counter phase A/B/Z; 2 latch inputs; 1 reset input	GX-EC0211
	2 line driver inputs	4 MHz input pulse frequency		GX-EC0241

## Wire Terminals Convert I/O Wiring to Pre-Terminated Cables

- Use with Omron high-density PLC input/output modules
- Reduce labor costs
- Eliminate wiring errors
- Conserve PLC rack capacity and panel space
- Reduce overall wiring back to the PLC
- Three row and insertion type also available



## Ordering Information

Description	Appearance	Contacts	Model
M3 screws, no terminal identification strip	XW2B-□□G4 (Regular M3 screws)	20	XW2B-20G4
		40	XW2B-40G4
		60	XW2B-60G4
M3.5 screws and protected terminal identification strip	XW2B-□□G5 (M3.5 screws)	20	XW2B-20G5
		40	XW2B-40G5
		60	XW2B-60G5
M3 Phillips screws and protected terminal identification strip		20	XW2D-20G6
ON/OFF status indicators; terminal identification strip			XW2C-20G5-IN16
Use short bars to handle PLC input or output units; terminal identification strip; ON/OFF status indicators			XW2C-20G6-IO16
Three-tier block for easy wiring; equipped with common terminal on the power supply tier; terminal identification strip			XW2E-20G5-IN16
M3 screw		34	XW2R-J34G-C**
Screw clamp		34	XW2R-E34G-C**
Spring clamp		34	XW2R-P34G-C**

\*\* -1, 2, 3 or 4 depending on I/O Unit Model (for more info go to [www.omron247.com](http://www.omron247.com))  
For other terminal sizes, refer to [www.omron247.com](http://www.omron247.com)



### Configuration

#### CJ-Series Basic I/O Unit (32 points)

- CJ1W-ID231 (Fujitsu connector/input unit)
- CJ1W-OD231 (Fujitsu connector/output unit)
- CJ1W-ID232 (MIL connector/input unit)
- CJ1W-OD232 (MIL connector/output unit)

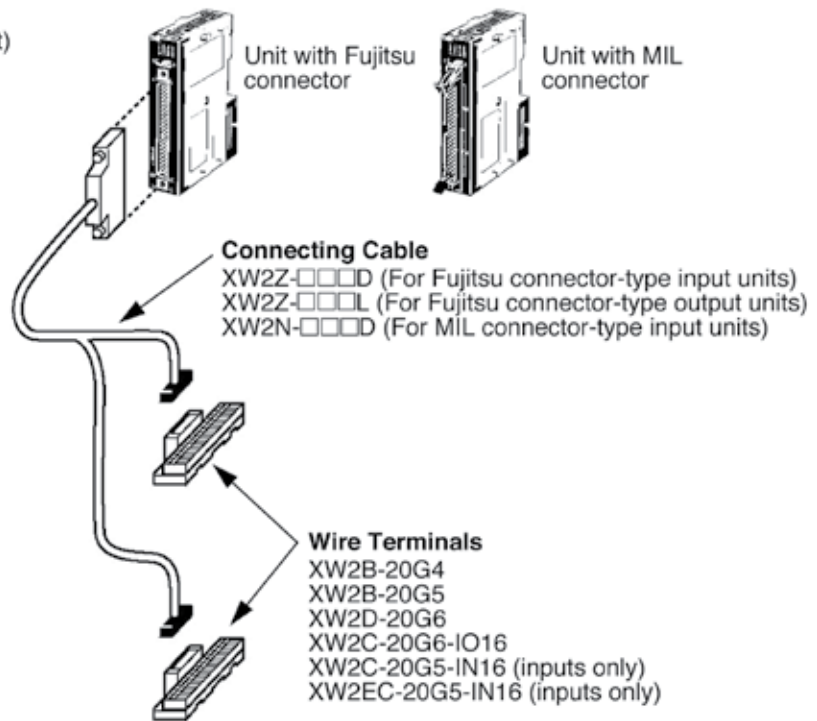

#### CJ-Series Basic I/O Unit (64 points)

- CJ1W-ID261 (Fujitsu connector/input unit)
- CJ1W-OD261 (Fujitsu connector/output unit)
- CJ1W-MD261 (Fujitsu connector, I/O unit)
- CJ1W-ID262 (MIL connector/input unit)
- CJ1W-OD263 (MIL connector/output unit)
- CJ1W-MD263 (MIL connector, I/O unit)
- CJ1W-MD563 (MIL connector, I/O unit)

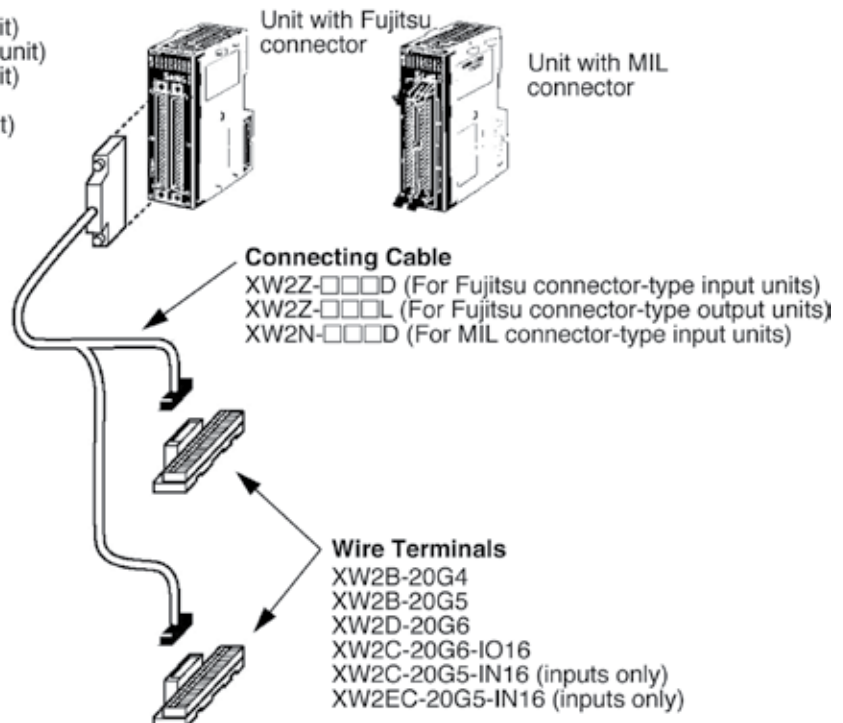



### Relay Terminals Buffer and Isolate I/O for the PLC Module

- Use with Omron high-density PLC input/output modules
- Reduce labor costs
- Use with Omron local and remote IO systems to give 120VAC inputs
- Use with Omron local and remote IO systems to give 10A independent common outputs
- Interchangeable relays allow a mix of SSR and electromechanical relays to match switching frequency of the attached device
- G79 cables provide error proof wiring between PLC module and relay terminal

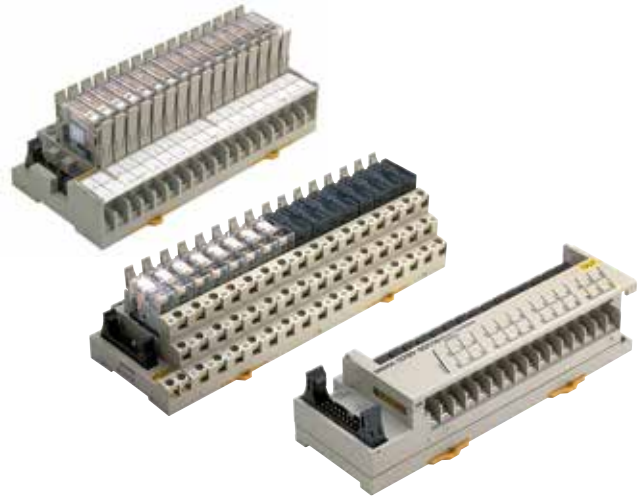

### Relay Terminal Blocks

Description	Specifications	Relays	Model	
Relay input terminal	NPN, 10 mA/pt., AC inputs	G7T relays installed	G7TC-IA16 AC110/120V	
	NPN, 10 mA/pt., DC inputs		G7TC-ID16 DC24V	
Relay output terminal	NPN, 10 A at 250 VAC/30 VDC		G7TC-OC16 DC24V	
	PNP, 10 A at 250 VAC/30 VDC		G7TC-OC16-1 DC24V	
Relay terminal base	NPN/PNP, 100 mA at 240 VAC/110 VDC		Order separately	G70A-ZIM16-5 DC24V
	NPN, 10 A 380 VAC/125 VDC			G70A-ZOC16-3 DC24V
	PNP, 10 A 380 VAC/125 VDC	G70A-ZOC16-4 DC24V		
Covered output terminal	NPN, 5 A max. 8 pt ON	G6D relays installed	G70D-SOC16 DC24	
	PNP, 5 A max. 8 pt ON		G70D-SOC16-1 DC24	
Vertical output terminal	NPN, 5 A max. 8 pt ON		G70D-VSOC16 DC24	
	PNP, 5 A max. 8 pt ON		G70D-VSOC16-1 DC24	

### Relay/SSRs for G70A

Type	G70A Terminal Base	Electromechanical Relay Model	Solid State Relay Model
Input	G70A-ZIM16-5 DC24V	G2R-1A3-SND DC24V	G3R-IAZR1SN AC100-240
		G2R-13-SND DC24V	G3R-IDZR1SN DC12-24
			G3R-IDZR1SN DC5
Output	NPN: G70A-ZOC16-3 DC24V PNP: G70A-ZOC16-4 DC24V	G2R-1-SND DC24	G3R-OA202SZN DC5-24
		G2R-1-SND DC12	G3R-ODX02SN DC5-24
			G3R-OD201SN DC5-24

# XS5 Cordsets/XS6 Connectors

## Industrial Ethernet Media

Quick Link

K249

omron247.com





### Supports EtherNet/IP, EtherCAT and Other Popular Networks Based on Ethernet

Omron offers a line of shielded high quality industrial cables for inside and outside the control panel.



- Cables are shielded to protect against EMI
- cULus approval markings on cable



### Ethernet Connector Cordsets

Appearance	Description	Cable length (m)	Model
	Cable with RJ45 connectors on both ends  Use with Sysmac NJ5 controllers, Accurax G5 servos (R88D-KN-ECT), 3G3MX2 AC drives with interface, GX EtherCAT Block I/O, GRT1-ECT SmartSlice I/O EtherCAT coupler, GX-JC EtherCAT Junction Slave	0.3	XS5W-T421-AMD-K
		0.5	XS5W-T421-BMD-K
		1	XS5W-T421-CMD-K
		2	XS5W-T421-DMD-K
		3	XS5W-T421-EMD-K
		5	XS5W-T421-GMD-K
		10	XS5W-T421-JMD-K
	Cable with M12 connector and RJ45 connector Use with FQ-M Vision Sensors, ERT1 EtherNet/IP Block I/O (IP67)	0.3	XS5W-T421-AMC-K
		0.5	XS5W-T421-BMC-K
		1	XS5W-T421-CMC-K
		2	XS5W-T421-DMC-K
		3	XS5W-T421-EMC-K
		5	XS5W-T421-GMC-K
		10	XS5W-T421-JMC-K
	Extension cable with M12 connectors on both ends	0.5	XS5W-T421-BM2-K
		1	XS5W-T421-CM2-K
		2	XS5W-T421-DM2-K
		3	XS5W-T421-EM2-K
		5	XS5W-T421-GM2-K
		10	XS5W-T421-JM2-K
		15	XS5W-T421-KM2-K
	Cable with M12 connector on one end and flying leads on the other	0.5	XS5W-T421-BM0-K
		1	XS5W-T421-CM0-K
		2	XS5W-T421-DM0-K
		3	XS5W-T421-EM0-K
		5	XS5W-T421-GM0-K
		10	XS5W-T421-JM0-K
		15	XS5W-T421-KM0-K

### Ethernet Connectors

Appearance	Description	Cable length (m)	Model
	RJ45 Assembly connector for on-site wiring	--	XS6G-T421-1
	Rear Locking M12 Connector for panel mounting	0.5	XS5P-T426-5
	Front Locking M12 Connector for Panel mounting	0.5	XS5P-T427-5

## Design Flexible Wiring Solutions

The GX-JC EtherCAT Junction Slaves provide the flexibility to use the most effective connection configuration for a wide range of applications.

- 3- and 6-port Junction Slaves are available for Daisy Chain, Star and Tree connections on EtherCAT networks
- Compact size
- Supply voltage range compensates for power voltage drop over long wiring distances
- Meets cULus Class I Division 2 rating for Products for Hazardous Locations



## EtherCAT Junction Slaves

Description	Number of ports	Power supply voltage	Dimensions (mm)	Current consumption	Model
EtherCAT junction slaves	3	20.4 to 28.8 VDC (24 VDC -15% to +20%)	25 W x 78 D x 90 H	0.08 A	GX-JC03
	6		48 W x 78 D x 90 H	0.17 A	GX-JC06

Note: Do not connect GX-JC EtherCAT junction slaves with Omron position control unit CJ1W-NC□81 or CJ1W-NC□82.



## Contents

Selection Guide		D-ii
<b>Human Machine Interfaces (HMI)</b>		
NA	Wide screen high-resolution displays with custom capabilities	D-2
NS	High-performance, bright, clear, and scalable, with advanced troubleshooting	D-3
NSJ	NS with integrated controller for DeviceNet nodes	D-4
NB	OEM-focused color touch screens, with exceptional graphics and essential features	D-6
NV	Compact, low-cost, monochrome and color touch screen	D-7
<b>Function Key (HMI)</b>		
NT11	Large alphanumeric 4-line Display with function keys	D-8
NT2S	Compact, powerful 2-line message display with function keys	D-9



## OMRON VISUALIZATION – CREATE AND OPERATE

Powerful visualization solutions from the most basic to advanced applications. Omron has the right visualization solution based on decades of global, field-proven experience.



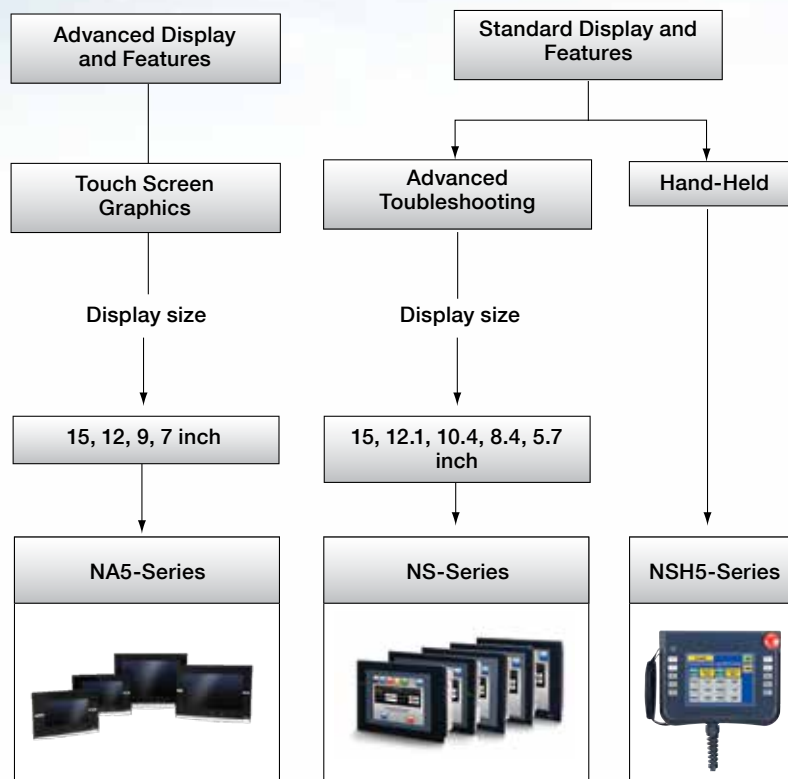

- Best touchscreen synergy with Omron automation products such as: Controllers, Temperature Controllers, Motion Systems, Vision and Industrial Networks
- Extremely reliable platforms, rugged, with industry-leading approvals and specifications
- Time-saving software and simulation tools, reduce costs and commissioning time
- Unparalleled built-in troubleshooting features, designed to reduce downtime
- Software suites include HMI screen design: Sysmac Studio, CX-One, and CX-One Lite (See section E)

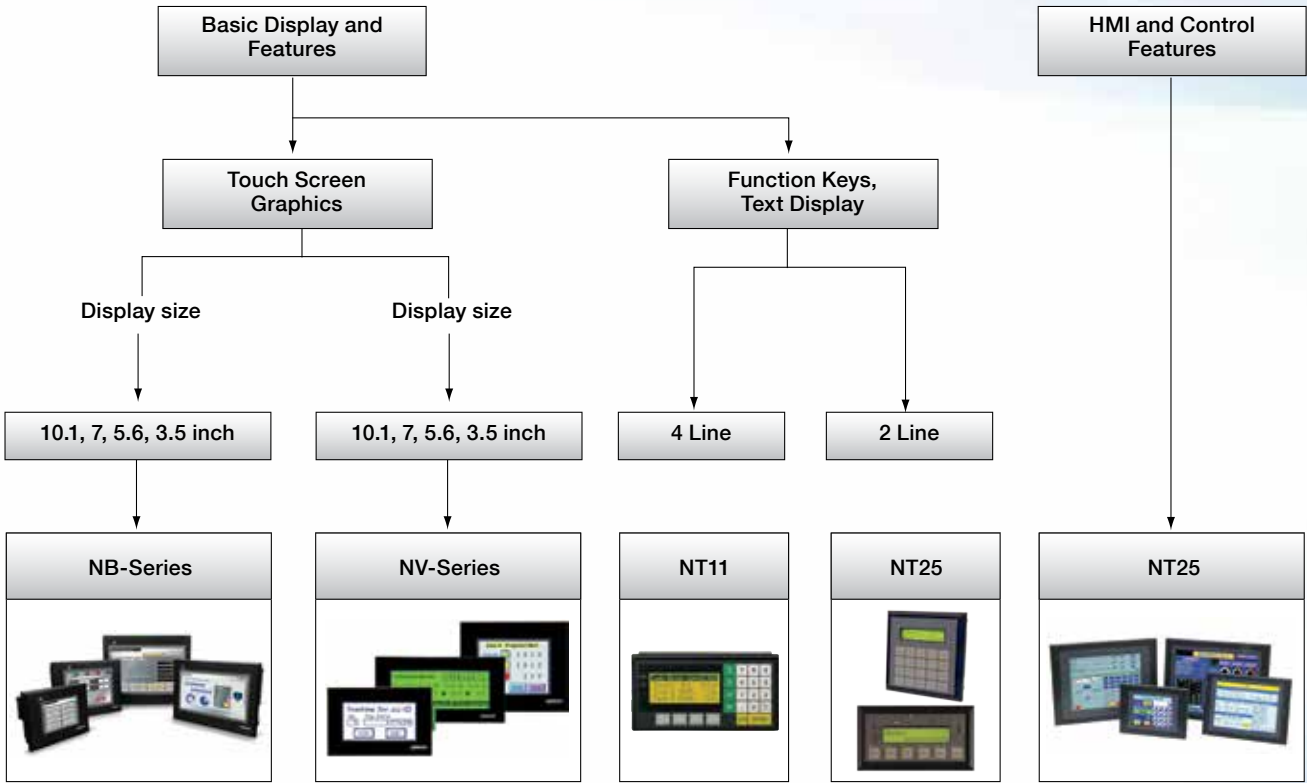

D



## Selection Table

	NA-Series			
				
Model	NA5-15	NA5-12	NA5-9	NA5-7
Display	15" TFT color wide screen	12" TFT color wide screen	9" TFT color wide screen	7" TFT color wide screen
Resolution	1280 x 800 pixels	1280 x 800 pixels	800 x 480 pixels	800 x 480 pixels
Number of colors	16,770,000 colors (24 bit full color)			
Memory Size	900MB (256MB screen memory)			
Communications	Ethernet, Serial RS232, USB			
Options	Black or Silver bezel			
Features	Windows Embedded Compact 7 operating system, VB.Net, MS Word, Excel, PDF and Video viewers, Remote Access, Wide screen display, SD memory card slot, USB slave port, USB master port, Expansion slot			
Dimensions (HxWxD mm)	16.5 x 11.5 x 2.7 (420 x 291 x 69)	13.4 X 9.6 X 2.7 (340 X 244 X 69)	11.4 X 7.5 X 2.7 (290 X 190 X 69)	9.3 X 6.9 X 2.7 (236 X 165 X 69)











# Selection Table



NS-Series						
						
Model	NS15	NS12	NS10	NS8	NS5	NSH5
Display	15 inch TFT color	12.1 inch TFT color	10.4 inch TFT color	8.4 inch TFT color	5.7 inch TFT color	5.7 inch STN color handheld
Resolution	1024 x 768 pixels (XGA)	800 x 600 pixels (SVGA)	640 x 480 pixels (VGA)	640 x 480 pixels (VGA)	320 x 240 pixels (QVGA)	320 x 240 pixels (QVGA)
Number of colors	256 (32,768 for image data)					256 colors (4096 colors for image data)
Memory Size	60MB screen memory					
Ethernet Available	Yes					No
Options	<ul style="list-style-type: none"> <li>• Controller Link</li> <li>• Video input board (NS-CA002)</li> <li>• Black or Silver bezel</li> </ul>	<ul style="list-style-type: none"> <li>• Controller Link</li> <li>• Video input board (RGB/Composite)</li> <li>• Black or ivory bezel</li> </ul>	<ul style="list-style-type: none"> <li>• Controller Link</li> <li>• Video input board (RGB/Composite)</li> <li>• Black or ivory bezel</li> </ul>	<ul style="list-style-type: none"> <li>• Video input board (RGB/Composite)</li> <li>• Black or ivory bezel</li> </ul>	<ul style="list-style-type: none"> <li>• Black or ivory bezel</li> </ul>	
Features	Omron EtherNet/IP tags, USB, FTP interface, Smart Active Parts (SAP), Single Port Multi Access (SPMA), Programming Console, Built-in Troubleshooter					Smart Active Parts (SAP), Single Port Multi Access (SPMA), Programming Console
Dimensions (HxWxD mm)	300 x 400 x 80	241 x 315 x 48.5	241 x 315 x 48.5	177 x 195 x 48.5	142 x 195 x 54	176 x 223 x 70.5 (excl. emergency button)

D

# Selection Table

NSJ-Series				
				
Model	NSJ12	NSJ10	NSJ8	NSJ5
Type of Display	12.1 inch color TFT	10.4 inch color TFT	8.4 inch color TFT	5.7 inch color TFT or STN
Display Size / Resolution	246×184.5 mm (800×600 pixels)	215.5×162.4 mm (640×480 pixels)	170.9×128.2 mm (640×480 pixels)	117.2×88.4 mm (320×240 pixels)
Control	<ul style="list-style-type: none"> <li>• CJ1G-CPU45H</li> <li>• 60k-steps program memory</li> <li>• 128k-words data memory</li> <li>• logic instruction time 0.04 μs</li> </ul>			
Communication	DeviceNet Master/Slave or PROFIBUS Master and optional Ethernet interface			
Expansion (1 board max.)	<ul style="list-style-type: none"> <li>• Controller Link</li> <li>• I/O extension</li> </ul>			
Dimensions (HxWxD mm)	<ul style="list-style-type: none"> <li>• Without expansion unit 241 × 315 × 73.3</li> <li>• With expansion unit 241 × 315 × 89.3</li> </ul>	<ul style="list-style-type: none"> <li>• Without expansion unit 241 × 315 × 73.3</li> <li>• With expansion unit 241 × 315 × 89.3</li> </ul>	<ul style="list-style-type: none"> <li>• Without expansion unit 177 × 232 × 73.3</li> <li>• With expansion unit 177 × 232 × 89.3</li> </ul>	<ul style="list-style-type: none"> <li>• Without expansion unit 195 × 142 × 79</li> <li>• With expansion unit 195 × 142 × 95</li> </ul>

NB-Series				
				
Model	NB10	NB7	NB5	NB3
Display	10.1 inch TFT Color	7 inch TFT Color	5.6 inch TFT Color	3.5 inch TFT Color
Resolution	800x480 pixels (WVGA)		320x234 pixels (QVGA)	320x240 pixels (QVGA)
Number of colors	65,536			
Memory Size	128MB			
Ethernet Available	Yes			
USB Host Available	Yes			
Features	50,000hr LED Backlight, Vector and Animated Graphics, Extensive Library, Pop-Up and Transparent Windows, Dual Serial Comm, Data Logging, Trending, Alarms, Granular Security, FREE software			
Dimensions (HxWxD mm)	268.8 x 210.8 x 54.0	148 x 202 x 46	142 x 184 x 46	129.8 x 103.8 x 52.8

	Compact Touchscreens	Function Key/Text Displays	
			
Model	NV3/NV4	NT11	NT2S
Features	<ul style="list-style-type: none"> <li>• Compact and horizontal models with 3.1-inch to 4.6-inch and QVGA displays</li> <li>• True Type Fonts for flexible screen designs</li> <li>• Space-saving installation</li> <li>• Multi-language support</li> <li>• Compatible with PLCs and controls from multiple global vendors</li> </ul>	<ul style="list-style-type: none"> <li>• Password protected screens</li> <li>• 4 function keys, number pad</li> <li>• Bar graph capability</li> <li>• Large characters</li> <li>• Long backlight life (50,000 hrs.)</li> </ul>	<ul style="list-style-type: none"> <li>• PLC message display</li> <li>• Programmable function keys</li> <li>• Password protected screens</li> <li>• 5 VDC power from PLC port</li> </ul>
Display	<ul style="list-style-type: none"> <li>• NV3W: 3.1-inch STN monochrome LCD</li> <li>• NV4W: 4.6-inch STN monochrome LCD</li> <li>• NV3Q-M: 3.6-inch STN monochrome LCD</li> <li>• NV3Q-S: 3.6-inch STN color LCD</li> </ul>	4 line x 20 character, backlit monochrome STN LCD	2 line x 16 character, LED backlit LCD
Resolution	<ul style="list-style-type: none"> <li>• NV3W: 128 x 64 pixels</li> <li>• NV4W: 320 x 120 pixels</li> <li>• NV3Q: 320 x 240 pixels</li> </ul>	160 x 64 pixels	–
Interface	<ul style="list-style-type: none"> <li>• Host Link, Modbus-RTU</li> <li>• RS-232C or RS-422A/RS-485</li> <li>• NV4W/NV3Q: USB tool port</li> <li>• NV3W: serial tool port</li> </ul>	<ul style="list-style-type: none"> <li>• Host Link</li> <li>• NT Link (1:1)</li> </ul>	<ul style="list-style-type: none"> <li>• Host Link</li> <li>• Multi-vendor PLC</li> </ul>
Number of colors	<ul style="list-style-type: none"> <li>• NV_W: 3 color backlight LEDs</li> <li>• NV3Q-M: 3 color backlight LEDs</li> <li>• NV3Q-S: 1 color backlight LED</li> </ul>	–	–
Memory Size	384 KB	32 KB	24 KB
Max. number of screens	<ul style="list-style-type: none"> <li>• NV3Q-MR: 240 screens</li> <li>• NV3Q-SW: 180 screens</li> <li>• NV4W: 250 screens</li> <li>• NV3W: 160 screens</li> </ul>	250	750
Dimensions (HxWxD mm)	<ul style="list-style-type: none"> <li>• NV3W: 72 x 110 x 28</li> <li>• NV4W: 74 x 146 x 30</li> <li>• NV3Q: 92.2 x 110 x 33.8</li> </ul>	113 x 218 x 38.2	6-key: 60 x 109 x 28 8-key: 106.9 x 106.9 x 35.9

## Wide Screen High Resolution Displays Impart High Value onto Any Machine

The NA series of advanced wide screen Human Machine Interfaces (HMI) offers one of the highest resolution wide screen displays in the industry. With features that allow designers to add functionality beyond what typical HMI devices had been able to offer, such as custom or machine specific capabilities, the NA series is the ideal machine automation HMI.



- Wide screen in all models: 7, 9, 12, and 15 inches
- More than 16 million color display for all models and 1280 x 800 high resolution display for the 12 and 15-inch models
- Multimedia including video Word, Excel and PDF
- 2 Ethernet ports capable of simultaneous access from both the NJ or NX automation controller and plant IT
- Sysmac Studio providing an Integrated Development Environment with the NJ and NX automation controller
- NJ and NX global variables are exposed to the NA. Test the complete system via the integrated Simulator
- Many security features including operation authority settings and execution restrictions with IDs
- Microsoft Visual Basic for versatile, flexible and advanced programming

## Ordering Information

Description	Size	Resolution	Memory size	Features	Model
Advanced High Resolution Wide Screen Touch-screen HMI	15-inch TFT	1280 x 800 pixels	256 MB	Ethernet, USB master and slave port, RS232, VB.Nett	NA5-15W101□
	12-inch TFT	1280 x 800 pixels			NA5-12W101□
	9-inch TFT	800 x 480 pixels			NA5-9W001□
	7-inch TFT	800 x 480 pixels			NA5-7W001□

□ S = Silver Bezel, B = Black Bezel

## Complete Machine Management with Advanced Troubleshooting

The NS-Series HMI has brilliant display screens that maximize machine visualization. Features include Omron EtherNet/IP tag support, easy USB communication, FTP interface on Ethernet models, Smart Active Parts (SAP) for easier design, Single Port Multi Access (SPMA) for one-point maintenance, Ladder Monitor, Programming Console, and Built-in Troubleshooters for Omron controllers. The screen design software, CX-Designer, is included in each of Omron's software suites - Sysmac Studio, CX-One, and CX-One Lite.

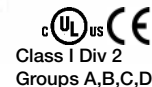

- Supports the NJ-Series Machine Automation Controller (MAC) with EtherNet/IP Tags
- Bright & Clear Displays: LED backlight and high contrast
- Scalable Projects: One software for all screens 5.7"-15", with automatic conversion
- Remote Maintenance & Operation: FTP Interface with Ethernet models
- Centralized Error Reporting: Built-in Troubleshooters for complete Omron solutions

## Ordering Information

Description	Size	Resolution	Memory size	Features	Model	
Standard touch-screen HMI with advanced troubleshooting	15-inch TFT	1,024 x 768	60 MB onboard	Ethernet	NS15-TX01B-V2	
	12.1-inch TFT	800 x 600		—	NS12-TS00B-V2	
	10.4-inch TFT	640 x 480		Ethernet	NS12-TS01B-V2	
				—	NS10-TV00B-V2	
				Ethernet	NS8-TV01B-V2	
	8.4-inch TFT		—	NS8-TV00B-V2		
			Ethernet	NS8-TV01B-V2		
	5.7-inch TFT High-Luminance	5.7-inch TFT	320 x 240	60 MB onboard	—	NS5-TQ00B-V2
				Ethernet	NS5-TQ01B-V2	
		—		NS5-SQ00B-V2		
Ethernet		NS5-SQ01B-V2				
5.7-inch TFT Handheld				—	NSH5-SQR00B-V2	



## Integrates Control, Display, and an Open I/O Network

Omron's NSJ-Series delivers the industry's most cost-effective and flexible combination of control, display and I/O capabilities in a single, space-saving package. True deterministic control, all NSJ terminals have separate but integrated processors for display and control tasks, so control response is never compromised due to heavy graphics demands.



UL US CE Class I Div 2 Groups A,B,C,D

- **Hardware Cost Savings:** Reduced number of components from a minimum seven to one, smaller control panel, less wires and conduit
- **Installation Time Savings:** One device installation, built-in self-diagnostic screens, monitor control program from display
- **Reduced Design Time:** No backplate layout required, easy to incorporate into existing systems, standardization, expandable and flexible hardware
- **Lower Operational Costs:** Reduced spares, 45% less power than separate controller and terminal
- **InnerBus Technology:** Built-in, fast, enriched communications, no need to purchase, setup or install Ethernet

## Ordering Information

Display size/type	Resolution	Programming/device ports			DeviceNet Master	Printer Port	I/O	Model
		Ethernet*	USB	Serial				
12.1-inch High-Luminance TFT color	800 x 600	Yes	Yes	Yes	Yes	USB	1280	NSJ12-TS01B-G5D
10.4-inch High-Luminance TFT color	640 x 480	Yes	Yes	Yes	Yes	USB	1280	NSJ10-TV01B-G5D
8.4-inch High-Luminance TFT color	640 x 480	Yes	Yes	Yes	Yes	USB	1280	NSJ8-TV01B-G5D
5.7-inch High-Luminance TFT color	320 x 240	Yes	Yes	Yes	Yes	No	1280	NSJ5-TQ11B-G5D
5.7-inch TFT color	320 x 240	Yes	Yes	Yes	Yes	No	1280	NSJ5-SQ11B-G5D

\* Models with built-in Ethernet do not support socket or mail services. If these are required, order a plug-in NSJW-ETN21 Ethernet Unit and an NSJ without built-in Ethernet.

## Network and Expansion Options

### Standard Configuration

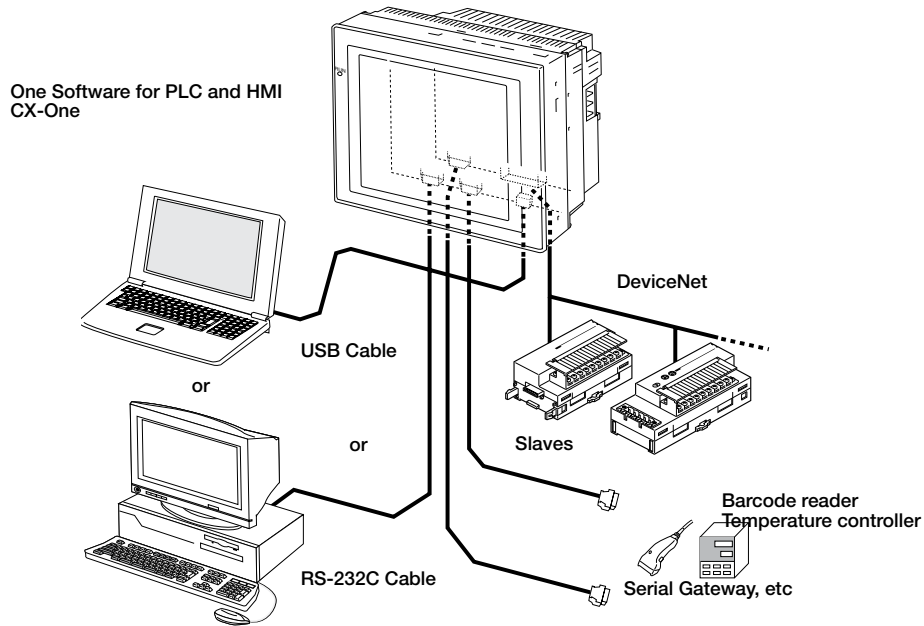

### Standard Configuration with I/O Expansion Unit

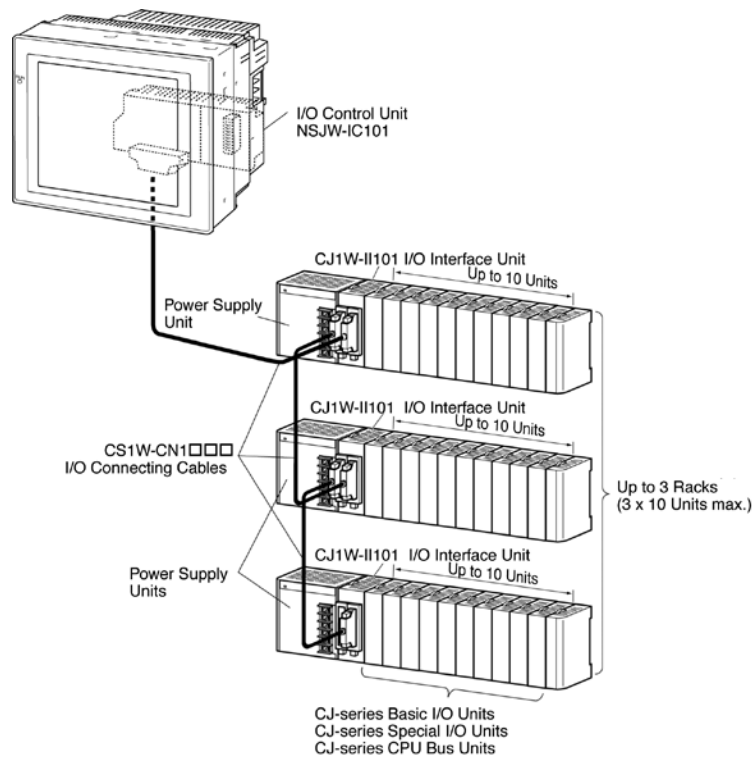

D

## OEM Focused Function Touch Screen

Think lean automation in vivid color. This screen provides best-in-class color and brightness with numerous features designed for CP1 PLC applications.

- 10.1, 7, 5.6 and 3.5 inch models
- 65K Color TFT Display with LED Backlight
- Dual Serial & USB Comm.
- Extensive Graphic Library
- Animation Support
- Data Logging/Trending, Recipes, Alarms
- Highly Granular User Login and Password protection
- FREE Downloadable Screen Design Software
- Template Screens for CP1 PLC



## Ordering Information

Display size	Resolution	Dual Serial, RS232/DF1	Ethernet TCP/IP, Ethernet/IP and USB Host	Model
10.1 inch	800 x 480 pixels	Yes	Yes	NB10W-TW01B
7 inch		Yes	No	NB7W-TW00B
		Yes	Yes	NB7W-TW01B
5.6 inch	320 x 234 pixels	Yes	No	NB5Q-TW00B
3.5 inch		Yes	Yes	NB5Q-TW01B
		No	No	NB3Q-TW00B
		No	Yes	NB3Q-TW01B



## Compact and Simple

Versatile mounting and essential features make this touchscreen ideal for tight spaces and basic interfaces.

- Extreme thin designs requiring only 1 inch of panel depth
- Choose from 3.1-, 3.6- or 4.6-inch LCD screen sizes
- Tri-color backlight or full-color displays for dynamic screen results
- Directly connect to Omron temperature controllers without need for PLC
- TrueType fonts with multi-language support for international markets
- Compatible with all Omron PLCs and global multi-vendor PLCs
- Easy-to-use NV Designer software



included in CX-One Lite or CX-One software suites

- USB and SD memory card options
- Mount in landscape or portrait orientation for more design flexibility

## Ordering Information

Screen size	Resolution	Backlight	Communications	Power supply voltage	Model
3.1-in. STN monochrome	128 x 64 pixels	LEDs, 3 colors (green, orange and red)	RS-232C	5 VDC	NV3W-MG20L
			RS-232C	24 VDC	NV3W-MG20
			RS-422A/485	24 VDC	NV3W-MG40
3.1-in. STN monochrome	128 x 64 pixels	LEDs, 3 colors (white, pink and red)	RS-232C	5 VDC	NV3W-MR20L
			RS-232C	24 VDC	NV3W-MR20
			RS-422A/485	24 VDC	NV3W-MR40
4.6-in. STN monochrome	320 x 120 pixels	LEDs, 3 colors (green, orange and red)	RS-232C	24 VDC	NV4W-MG21
			RS-422A/485	24 VDC	NV4W-MG41
4.6-in. STN monochrome	320 x 120 pixels	LEDs, 3 colors (white, pink and red)	RS-232C	24 VDC	NV4W-MR21
			RS-422A/485	24 VDC	NV4W-MR41
3.6-in. STN monochrome	20 x 240 pixels (QVGA)	White LED	RS-232C	24 VDC	NV3Q-SW21
			RS-422A/485	24 VDC	NV3Q-SW41

D

## Large Alphanumeric 4-Line Display with Function Keys

Compact, simple and easy to use operator interface allows accurate monitoring and controlling, and includes slide-in legend for custom labeling of function keys. The extra-large keys on the numeric keypad provide operators the tactile feedback for quick data input or screen change, even when wearing thick work gloves.

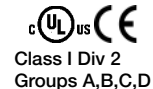

- 4 line x 20 character backlit LCD display
- Mix 1- and 2-wide characters in one display; inverse display selectable
- 32KB memory (up to 250 screens)
- 4 global programmable function keys use menu-based screen navigation
- Keypad allows operators to input and enter numeric data
- Bar graph capability
- Password-protected screens
- Printer port built in (25-pin female connector)
- Host link/1:1 NT link communication
- Contrast control
- NEMA 4
- Black or ivory front bezel

## Ordering Information

Display data source	External settings	Power supply	Features	Model
Programmable	4 function keys	External 24 VDC	Ivory case	NT11-SF121-EV1
			Black case	NT11-SF121B-EV1

## Cables

Function	Connections	Applicable models	Cable length	Model
Connect NT11 to Programming cable	9-pin RS-232C to RS-232C for PC	—	2 m	C200H-CN229-EU CBL-202 in Canada
Connect NT11 to Omron PLC	9-pin D-sub to PLC 9-pin serial port	CPM1, CPM2, CQM1, C200H/C200HE/C200HG/C200HX, CP1, CJ2, CS1	0.5 m	C200H-CN510-EU
			3 m	C200H-CN320-EU
5 m	C200H-CN520-EU			
	9-pin D-sub to PLC mini-peripheral port adaptor	CPM2, CQM1H, CJ1, CS1	2 m	CS1W-CN118
NT Series Support Tool Software	—	—	—	NT-ZJCAT1-EV4

## Compact Powerful 2-Line Message Display with Function Keys

- High-visibility backlit LCD display shows 2 lines of 16 characters
- Programmable or PLC message display models available
- Multi-vendor PLC support models available
- 6 or 8 function keys available for screen and project level assignment
- Easy numeric entry using arrow or numeric keypad
- Two bit-assignable LED indicators on 6-key models
- Power from PLC peripheral port or external 24 VDC power supply
- Password protect any programmable function key
- Built-in bar graph display capability



- IP65 enclosure rating
- All models meet cULus, CE, and Class I, Division 2 ratings for use in hazardous areas
- Programming software available free from our website

## Ordering Information

Display data source	External settings	Features	Power supply voltage	Model
Programmable	6 function keys	Real-time clock; multi-vendor PLC support	External 24 VDC (1.5 W)	NT2S-SF121B-EV2
PLC ASCII-based program		–	5 VDC (0.75 W)	NT2S-SF122B-EV2 NT2S-SF123B-EV2
Programmable		8 function keys, number pad	Real-time clock, multi-vendor PLC support	External 24 VDC (1.5 W)
PLC ASCII-based program	–		5 VDC (0.75 W)	NT2S-SF126B-E NT2S-SF127B-E

# Human Machine Interfaces

---

## Contents

Selection Guide		E-ii
<b>Software</b>		
Sysmac Studio Software Suite	Configure, program, simulate, and maintain an entire NJ-Series machine	E-1
CX-One	One software for complete system setup, design, operation, and maintenance	E-2
SCADA	PC-based visualization and middleware	E-4
NS-Runtime	PC-based HMI emulator	E-6

## CONFIGURE, DEVELOP, COMMISSION IN ONE

### One Software for your entire application

Applications will dictate the controller, which will dictate the software. Omron provides complete software suites which include all the tools necessary to create the best solution for your application, with easy licensing, free online updates, and guaranteed interoperability. For enterprise connectivity, separate Supervisory Control And Data Acquisition (SCADA) software expand data visualization and management capabilities from local to global.

- Sysmac Studio and CX-One (Lite) software suites provide single software part number and licensing for an entire application
- Software suites allow for configuration, programming, troubleshooting, and maintenance of all related hardware
- Free Online AutoUpdates for Sysmac Studio and CX-One (Lite)
- SCADA software connect Omron solutions to multiple-driver systems, with multiple databases, and web deployment

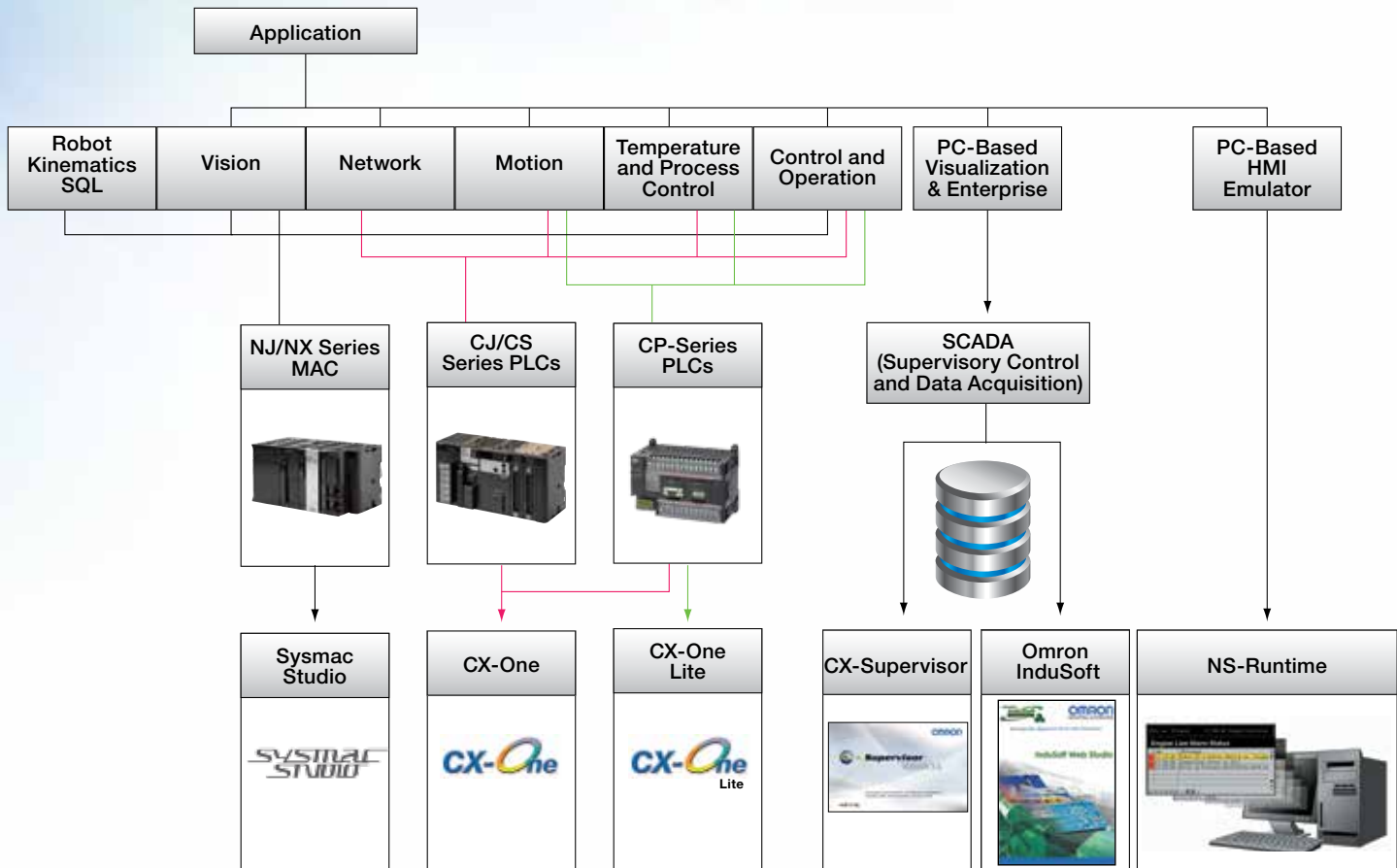

## Sysmac Studio for Machine Creators

The Sysmac Studio true Integrated Development Environment (IDE), part of the Sysmac Studio Software Suite, provides a single operating environment to setup, program, debug, and maintain an entire Sysmac NJ/NX-Series machine solution.

- One software for configuration, logic, motion, vision, safety, drives, networks, I/Os and enterprise
- True tag-based environment supporting Ladder, ST, safety FBD, and user-made Libraries following IEC 61131-3 and PLCopen standards



- Integrated 3D motion simulation tool and graphical CAM editor
- FREE Online AutoUpdates

## PC System Requirements

OS	CPU		RAM	Display
Windows XP SP3 Windows Vista Windows 7 (32-bit or 64-bit edition)	Minimum	IBM AT or compatible with Celeron 540 (1.8 GHz) processor	2 GB	XGA 1,024 x 768, 16 million colors
	Recommended	IBM AT or compatible with Core i5 M520 (2.4 GHz) processor or the equivalent	2 GB	WXGA 1,280 x 800, 16 million colors

## Ordering Information

Number of users	License and Media model		License Only	DVD Only
	DVD Quantity	Model	Model	Model
1	1	SYSMAC-STUDIO-1USER	SYSMAC-SE201L	SYSMAC-SE200D
3	1	SYSMAC-STUDIO-3USER	SYSMAC-SE203L	
10	3	SYSMAC-STUDIO-10USER	SYSMAC-SE210L	
30	10	SYSMAC-STUDIO-30USER	SYSMAC-SE230L	
50	16	SYSMAC-STUDIO-50USER	SYSMAC-SE250L	
Site	20	SYSMAC-STUDIO-SITE	SYSMAC-SE2XXL	
Vision	1	SYSMAC-STUDIO-VISION	SYSMAC-VE001L	
Measurement	1	SYSMACSTUDIOMEASURE	SYSMAC-ME001L	

Notes:

- Sysmac Studio is fully compatible with CX-One V4.22 or higher.
- Sysmac Studio DVD can be installed without a license for a 30-day full functionality trial. Licenses can be purchased and registered separately.
- Software must be registered online in order to use FREE Online AutoUpdates.

## Sysmac Studio Software Suite Contents

Subject	Sysmac Studio	Description
Programming	Sysmac Studio (IDE)	A true Integrated Development Environment for Logic, Motion, Vision, Safety and Simulation. Also includes equivalent functionality to CX-Drive for AC Drives & Servos.
	CX-Designer	CX-Designer is used to create screen data for NS-series HMIs.
Networks	CX-Integrator & Network Configurator EtherNet/WW	CX-Integrator & Network Configurator EtherNet/IP allow for easy network setup. They enable monitoring of the connection status, setting parameters, and diagnostics.
	CX-ConfiguratorFDT	Based on FDT/DTM technology, CX-ConfiguratorFDT can be used to configure devices from any vendor connected to a PROFIBUS network.

## For Complete PLC Applications

The CX-One (Lite) Software Suite enables users to configure and program, PLCs, HMIs, motion control systems, drives, networks, and temperature controllers. The benefit of a single software is to reduce complexity of the configuration and allow automation systems to be programmed or configured with maximum integration and performance.

By registering online, users can benefit from free online AutoUpdates. AutoUpdates keep CX-One current with new modules, functions and features..

The Full CX-One software supports all CJ/CS/CP PLCs, HMI, Motion, Network,



Temperature/Process Control, and Drive products. A separate Lite version is available for Micro-PLC users, without motion control or advanced networking.

## Ordering Information

Number of Users – CX-One	Media	Standard License Model	Upgrade License Model (from previous version with same users)
1-user licence	DVD	CXONE-AL01D-V4	CXONE-AL01D-V4-UP
3-user licence	DVD	CXONE-AL03D-V4	CXONE-AL03D-V4-UP
10-user licence	DVD	CXONE-AL010D-V4	CXONE-AL010D-V4-UP
30-user licence	DVD	CXONE-AL030D-V4	CXONE-AL030D-V4-UP
50-user licence	DVD	CXONE-AL050D-V4	CXONE-AL050D-V4-UP
Site licence	DVD	CXONE-AL0XXD-V4	CXONE-AL0XXD-V4-UP

Number of Users – CX-One Lite	Media	Model
1-user licence	CD	CXONE-LT01C-V4

Note: CX-One Lite is available for Micro-PLC users, without motion control or advanced networking.

## CX-One Software Suite Contents

Subject	CX-One Sub-Component	Description
Programming	CX-Programmer	CX-Programmer provides one common PLC software platform for all types of Omron PLC controllers – the CS1, CJ2, and CP1-Series, as well as legacy PLCs. It allows easy conversion and re-use of PLC code between different PLC types, and code migration from legacy PLC programming software.
	CX-Simulator	A debugging environment equivalent to the actual PLC system and NS HMI system environment can be achieved by simulating the operation of a CS/CJ Series PLC with a virtual PLC or NS HMI in the computer. CX-Simulator makes it possible to evaluate program operation, check the cycle time and reduce debugging time before the actual equipment is assembled.



Subject	CX-One Sub-Component	Description
Programming	CX-Designer	CX-Designer is used to create screen data for NS-series HMIs. CX-Designer can also check the operation of the created screen data on the computer. CX-Designer enables efficient development process for screen creation, simulation and project deployment. Users can develop screens more efficiently with Easy-to-use Support Software. CX-Designer has about 1,000 standard functional objects with associated graphics and advanced functions, so even first-time users can create screens easily just by arranging functional objects in a screen.
Networks	CX-Integrator & Network Configurator	CX-Integrator & Network Configurator are the main configuration software for CX-One. It enables easy performance of many operations, such as monitoring the connection status of various networks, setting parameters, and diagnosing networks.
	CX-ConfiguratorFDT	Based on FDT/DTM technology, CX-ConfiguratorFDT can be used to configure devices from any vendor connected to a PROFIBUS network. This concept will later be expanded to support many more networks using this technology.
Motion & Drives	CX-Motion	CX-Motion can be used to create, edit, and print the various parameters, position data, and motion control programs (G code) required to operate Motion Controllers, transfer the data to the Motion Control units, and monitor operation of the Motion Control units. Increase productivity in every step of the motion control process, from development of the motion control program to system operation.
	CX-Drive	The complete current range of inverters and servos is covered in this software with full access to all parameters (with 3 different operator levels available). An easy overview of parameters is also included which includes filters to show values that are: different from default, different from inverter, invalid setting. Graphical overviews are available to further assist with configuration of some more detailed parameters such as jump frequencies, v/f profiles and analogue setting.
	CX-Position	CX-Position simplifies every aspect of position control, from creating/editing the data used in Position Control units (NC units to communicating online and monitoring operation. The software is equipped with functions that can improve productivity, such as automatically generating project data and reusing existing data.
Temperature & Process Control	CX-ThermoTools	CX-ThermoTools is a configuration and monitoring product for E5CN and E5ZN-series Temperature Controllers. It provides easy setup, online data logging, and real-time monitoring. Users can easily create, edit, and batch-download parameters from a personal computer, reducing the work required to set parameters. It is possible to monitor data for up to 31 Temperature Controllers at the same time.
	CX-Process	CX-Process simplifies every aspect of loop control, from creating/transferring function blocks to running the Boards/units and debugging (tuning PID parameters, etc.) operation. Function block programs can be created easily by pasting function blocks in the window and making software connections with the mouse.

### PC-Based Visualization Solutions

Visualization software, hosted on a PC or server, is the best solution for integrating an industrial automation system into the non-industrial IT space. These solutions provide graphic interfaces for monitoring and control, as well as simplified database connectivity and remote access capabilities.

**CX-Supervisor** is for applications using Omron controllers only, boasting powerful functions for a wide range of PC based HMI requirements. Simple applications can be created rapidly with the aid of a large number of predefined functions and libraries, and even very complex applications can be generated with a powerful programming language or VBScript.



**Omron InduSoft** provides multi-vendor driver and database connectivity for systems with third-party device requirements. Scalable remote access options are available over the internet, as well as redundant server technology for the highest data integrity. The runtime is scalable enough to run on any version of Windows, including Windows Embedded/CE on mobile devices using softkey licenses. USB hardkeys are optional for developers who switch between several PCs.

### Ordering Information

Description	Media	Model
CX-Supervisor Developer & runtime (no protection included)	CD	CX-SUPERVISOR-V□
CX-Supervisor Developer upgrade (no protection included, requires license of previous version)	CD	CX-SUPERVISOR-UPGR-V□□
CX-Supervisor Machine Edition runtime including USB dongle protection	CD	CX-SUPERVISOR-RUN-ME-V□□
CX-Supervisor PLUS Edition runtime including USB dongle protection	CD	CX-SUPERVISOR-RUN-PLUS-V□□
Omron InduSoft Development & Runtime License with CX-Compolet middleware	CD	OMSGY-□□□□□-NT
Omron InduSoft Development Only License with CX-Compolet middleware	CD	OMSGY-□□□□□-DEV
Omron InduSoft Runtime Only License with CX-Compolet middleware	CD	OMSGY-□□□□□-RT
Omron InduSoft Web Thin Client (Optional Upgrade)	-	OM-□□□□-WS
Omron InduSoft Secure View Thin Client (Optional Upgrade)	-	OM-□□□□-SV
Omron InduSoft Studio Mobile Access Thin Client (Optional Upgrade)	-	OM-□□□□-SMA
Omron InduSoft Optional Hardkey License	USB	OM-USB-HK(-RT)
Omron InduSoft Optional Hardkey License	Parallel	OM-HARDKEY-RT/NT
Omron InduSoft License Level Upgrades (Development & Runtime)	-	OM-□□□□□-NT-SPUPG
Omron InduSoft License Level Upgrades (Development Only)	-	OM-□□□□□-DEV-SPUPG
Omron InduSoft License Level Upgrades (Runtime Only)	-	OM-□□□□□-RT-SPUPG
Omron InduSoft Software Version Upgrade (Development & Runtime)	-	OMSGY-□□□□□-UPG
Omron InduSoft Software Version Upgrade (Development Only)	-	OMSGY-□□□□□-DEV-UPG
Omron InduSoft Software Version Upgrade (Runtime Only)	-	OMSGY-□□□□□-RT-UPG
Omron InduSoft Web Thin Client Upgrade	-	OM-□□□□-WS-SPUPG
Omron InduSoft Secure Viewer Thin Client Upgrade	-	OM-□□□□-SV-SPUPG
Omron InduSoft Studio Mobile Access Thin Client Upgrade	-	OM-□□□□-SMA-SPUPG

## Specifications

Feature	CX-Supervisor		Omron Indusoft
	Machine Edition	Plus Edition	
Scripting	Yes		Yes
Recipes	Yes		Yes
Alarms	300	5000	Unlimited
Animation	Yes		Yes
Max devices (PLCs etc)	20	256	Unlimited
OPC connections	Yes		Yes
Max Points / Tags	500	8000	Dependent on License Level
Max Regular Interval Scripts	10	100	Multi-thread Simultaneous Scripts
Max Pages / Screens	100	500	Unlimited
Supported databases	MS Access	MS Access, MS Excel, MS SQL, CSV, dBase, ODBC	MS Access, MS Excel, MS SQL Server, MySQL, Oracle, Sybase
Third-party drivers	No		Yes, Multiple Simultaneous
Redundant server	No		Yes
Mobile Device Support	No		Yes

## Emulates NS-Series HMIs on PCs

NS-Runtime provides the ability to operate a CX-Designer application on a PC where an open platform environment is required. This allows the PC to function as a dedicated operator interface in factory automation settings. It can also be used as a supervisory tool to view factory run rates.



- Scalable visualization, regardless of dedicated or PC-based operator interface requirements, from one CX-Designer project
- Run a new application created with CX-Designer (up to 3840 x 2400 pixels) on a Windows PC
- Communicate with Omron CJ, CP1 and CS PLCs via Ethernet, Controller Link or Serial
- Reuse existing NS-Series projects with additional functionality, like PDF document viewer and running other Windows applications
- Run an existing NS-Series project as an additional PC-based operator interface, either on-site or at remote locations and for OEMs for remote maintenance
- Have NS-Runtime available on-site as a PC-based backup in case the dedicated NS-Series operator interface is damaged
- Supplied with USB dongle
- Barcode reader to USB port support
- Additional macros for string manipulation, window manipulation, and launching applications
- Expansive data log capacity: 160,000 points compared to NS-Series' 50,000 points

## Ordering Information

Description	Model
NS-Runtime (1) License, CD ROM, USB Dongle, Documentation	NS-NSRCL1
NS-Runtime (3) Licenses, CD ROM, USB Dongle, Documentation	NS-NSRCL3
NS-Runtime (10) Licenses, CD ROM, USB Dongle, Documentation	NS-NSRCL10

NOTE: NS-Runtime does not yet support the NJ-Series Machine Automation Controllers (MAC)

## Contents

Selection Guide		F-ii
<b>Motion Controllers</b>		
Sysmac, NJ and NX Series	Machine Automation Controller with advanced motion at the core	F-1
CJ1W-NC□8□	Position Control Unit, EtherCAT, for CJ PLCs	F-2
CJ1W-NC□71	Position Control Unit, MECHATROLINK-II, for CJ PLCs	F-3
C200H-MC402-E	Motion Control Unit, Analog, for CS PLCs	F-4
CS1W-MC□21	Motion Control Unit, Analog, for CS PLCs	F-5
CJ1W-NC□□3	Position Control Unit, Pulse Output, for CJ PLCs	F-6
CS1W-NC□□3/ C200HW-NC□□	Position Control Unit, Pulse Output, for CS PLCs	F-7
H8PS	Stand-alone Cam Positioner	F-8
<b>Rotary Encoders</b>		
See Section R for Rotary Encoders.		



## TOTAL FREEDOM IN MOTION CONTROL

Machine builders and OEMs that require motion and machine control systems find high value and flexibility in Omron's Scalable Machine Solutions. From single-function compact machines to the most flexible production cells, Omron helps you turn ideas into machines that work. We support simple point-to-point positioning to synchronized motion control from our portfolio of robust Machine Automation Controllers (MAC) and PLCs, and Motion Controllers that are discretely wired or network connected.

Scalable Machine Solution – Controllers:

- Lean Automation: CP1 PLC Pulse Output for Position Control
- Mainstream Automation: CJ Hybrid PLC and Motion with Networked Control
- X-Stream Automation: Sysmac NJ/NX up to 256 synchronized axes for X-Stream Machine Control

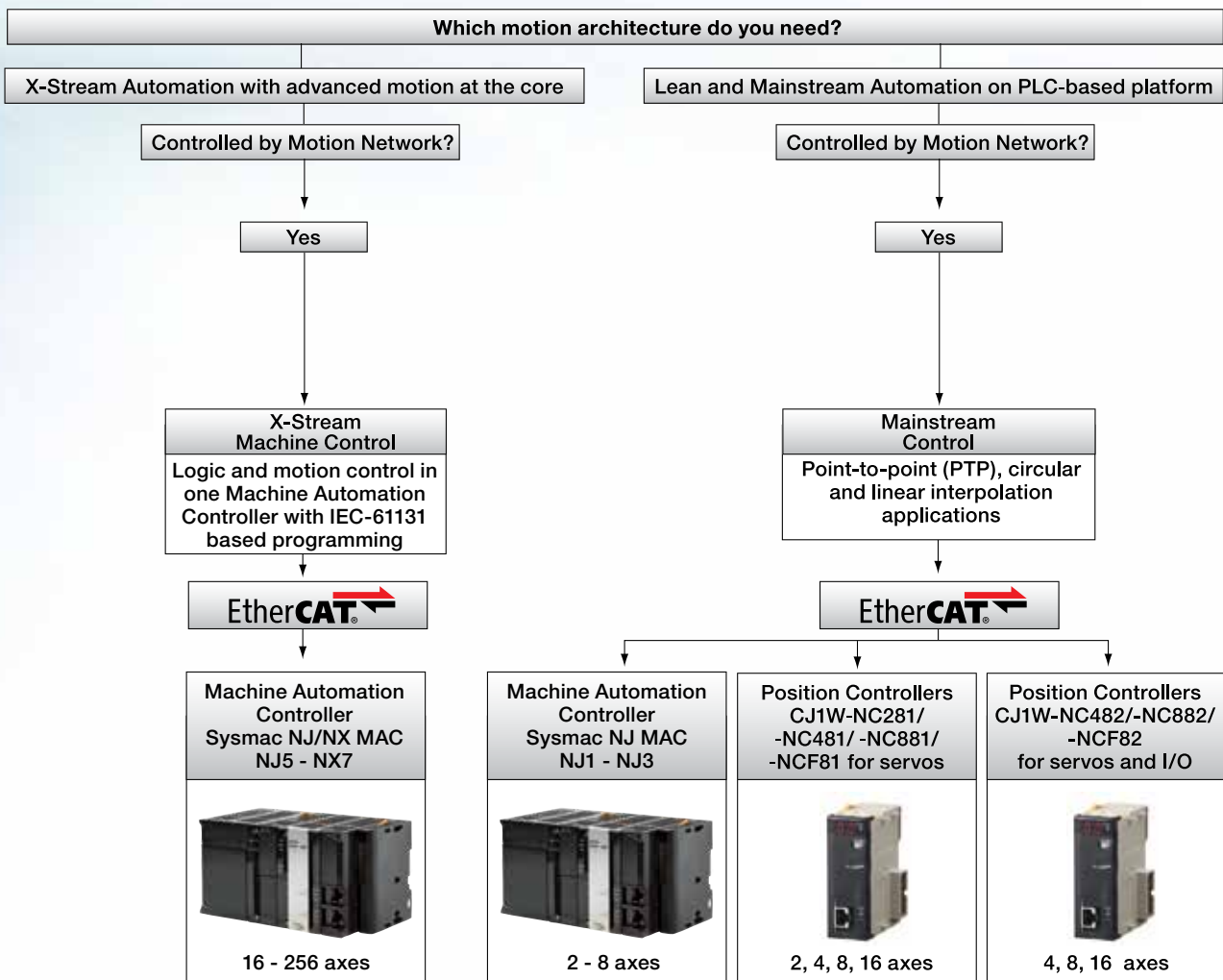

\*See Section A

# Scalable Machine Solution-Controller



Lean Automation  
CP1 PLC with built-in pulse output for position control



Mainstream Automation  
CJ series hybrid PLC and motion with networked control





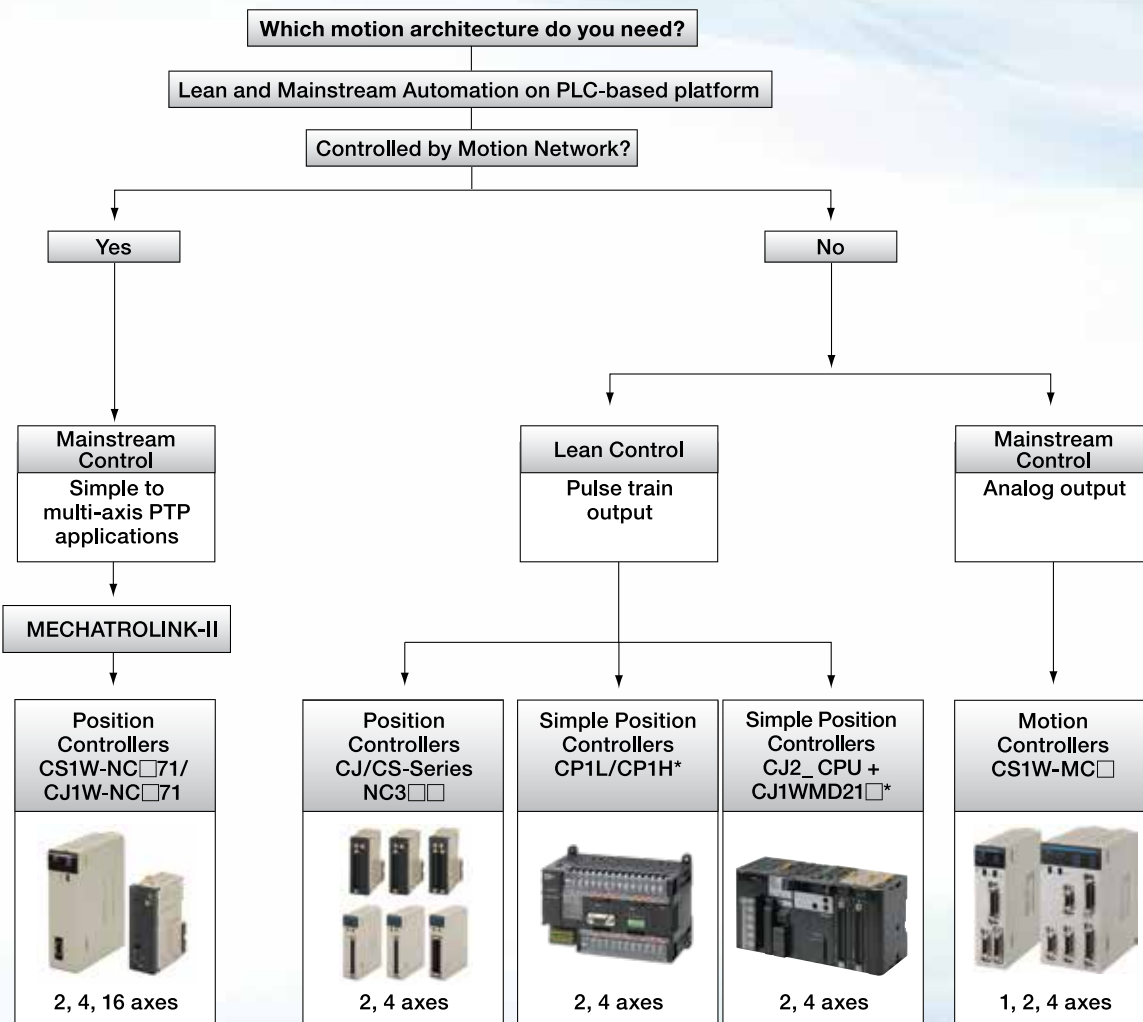



Sysmac NJ/NX stand-alone for complete machine automation control for up to 256 axes synchronized.



F

# Selection Table

Type	Networked Motion Controllers		
			
Model	Sysmac NJ/NX Series* (*Note: See Section A for details)	CJ1W-NC□81/ -NC□82	CJ1W-NC□71/ CS1W-NC□71
Description	Machine Automation Controller with advanced multi-axes coordinated motion and complete machine control	PLC based positioning controller	PLC-based point-to-point positioning controller
Axes control method	• EtherCAT motion bus built in	• EtherCAT motion bus	• MECHATROLINK-II motion bus
Number of axes	NX701: 128 or 256 axes NJ501: 16, 32 or 64 total axes NJ301: 4, 8 real axes - 15 total NJ101: 2 axes	2, 4, 8, 16	2, 4, 16
Applicable servo drive	Accurax G5 series (R88D-KN□□-ECT)	Accurax G5 series (R88D-KN□□-ECT)	Accurax G5 series (R88D-KN□□ML2)
Application	<ul style="list-style-type: none"> <li>• Complete Machine Control / Cell Control</li> <li>• Advanced Motion</li> <li>• E-cam, gearing, circular/linear Interpolation</li> <li>• Registration &amp; Phase shift on-the-fly</li> <li>• PLS</li> </ul>	<ul style="list-style-type: none"> <li>• Simple point-to-point</li> <li>• Linear &amp; circular interpolation</li> <li>• Registration</li> <li>• PLS</li> </ul>	<ul style="list-style-type: none"> <li>• From simple point-to-point to multi-axis point-to-point coordinated systems</li> </ul>
Servo control mode	Position, Speed, and Torque	Position, speed & torque	Position, speed & torque
Platform series	Sysmac NJ-Series Machine Automation Controller. EtherNet/IP built in	CJ-Series PLC with Positioning Motion Module(s). CJ2 has EtherNet/IP built-in	CJ and CS1 Series PLC with Positioning Motion Module(s). CJ2 has EtherNet/IP built-in

Type	Hard Wired Motion Controllers			
				
Model	CJ2M-MD21*	CP1L / CP1H	CS1W-MC_21	CJ1W-NC_3/ CS1W-NC_3
Description	PLC-based	Micro PLC-based	PLC-based motion controller with multi-tasking. G-code programming capability	PLC-based, point-to-point positioning controller
Axes control method	• Pulse train output	• Pulse train output	• Analog output	• Pulse train output
Number of axes	2, 4	2, 4	2, 4	1, 2, 4
Applicable servo drive	SmartStep2 (R7D-B), Accurax G5 series (R88D-KT)	SmartStep2 (R7D-B), Accurax G5 series (R88D-KT)	Accurax G5-Series (R88D-KT)	SmartStep2 (R7D-B), Accurax G5-Series (R88D-KT)
Application	<ul style="list-style-type: none"> <li>• Point-to-point Indexing</li> <li>• Interrupt feeding</li> </ul>	<ul style="list-style-type: none"> <li>• Point-to-point Indexing</li> </ul>	<ul style="list-style-type: none"> <li>• Point-to-point with complex interpolations</li> </ul>	<ul style="list-style-type: none"> <li>• Point-to-point applications</li> </ul>
Servo control mode	Position	Position	Position, speed	Position
Platform series	CJ2-Series PLC with simple positioning module	CP1-Series Micro PLC with simple positioning capabilities built-in	CS-Series PLC with motion module(s)	CJ- and CS-Series. CJ2 has EtherNet/IP built-in



## Fully Integrated Control

The NX/NJ-Series includes capabilities for seamless integration of Logic, Motion, Vision, Safety, Networks, and Enterprise level control. Selectable models based on application requirements.

- Built-in EtherNet/IP & EtherCAT network interfaces
- Built-in 0 to 256 axes of advanced motion control capabilities
- Local and remote I/O options including Failsafe Safety over EtherCAT
- Available built-in SQL Database Connectivity
- Available built-in Robot Kinematics
- Available SECS/GEM Protocol
- Complete Sysmac Solution configured, programmed, and commissioned using Sysmac Studio software (see Quick Link L432)

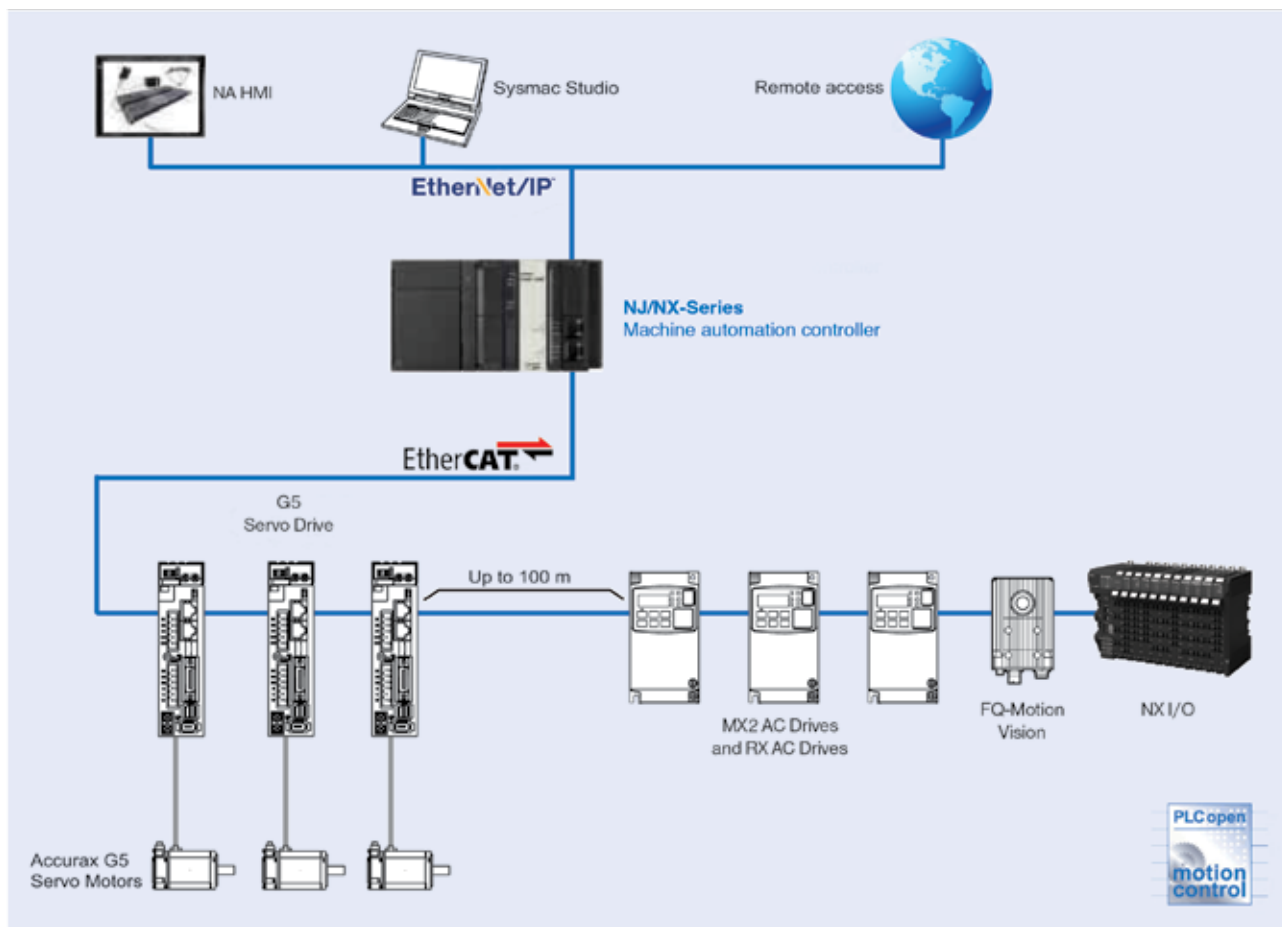

Note: See Section A for Sysmac Controller.

# Position Control Units

## CJ1W-NC□81/82 – EtherCAT Interface

Quick Link

F434

omron247.com

### Advanced control performance and easy operation with EtherCAT improves production efficiency

The EtherCAT communications with 100Mbps baud rate enables fast and accurate position control for 2, 4, 8 or 16 axes. A wide range of position control functions are available with this position control unit CJ2 PLCs.

- Fast positioning operation: taking from 0.15 to 0.4ms (min.) to start servo operation from PLC start command
- Support for Servomotors with Absolute Encoders
- Monitor the Deviation between Axes during Linear Interpolation
- A Wide Range of Positioning Operations
- Comes with Memory Operation function
- Common control interface with pulse-train type position control unit (CJ1W-NC□8□)
- Fast communication of EtherCAT (250µs min. communications cycle)
- Complete automation: servo, inverters, vision and I/O devices using EtherCAT
- Support for Servomotors Speed Control and Torque limit outputs

EtherCAT®



Used to set and monitor data.

- Editing parameters and data
- Monitoring status
- Data tracing
- Managing files Etc.

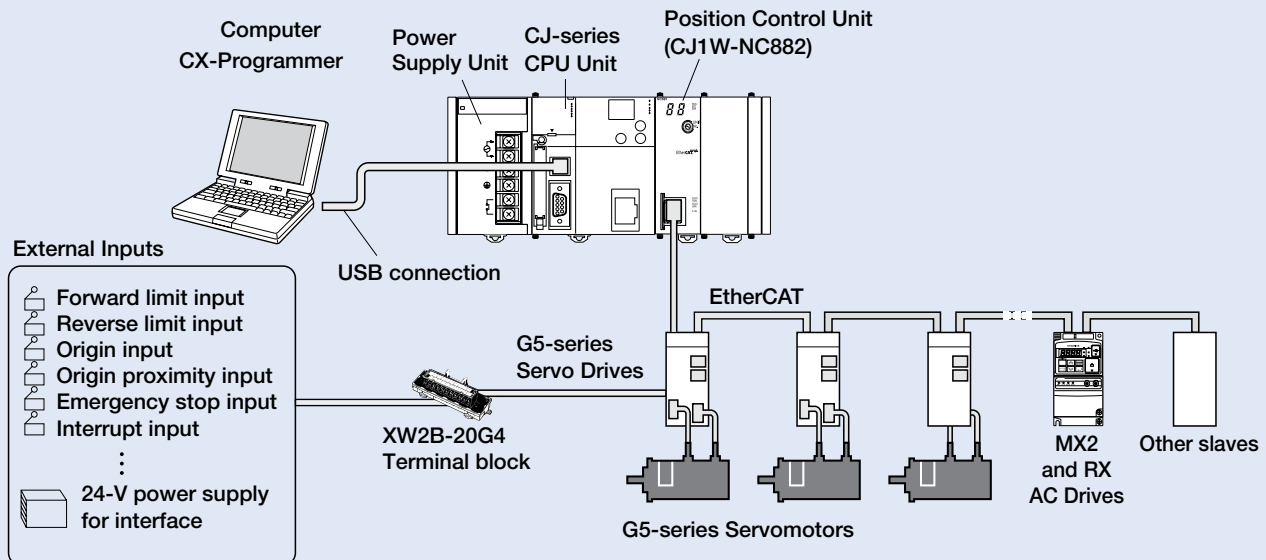

**Note:** The controller does not allow user to add ESI files. Only EtherCAT listed in CX-Programmer can be used.

EtherCAT® is a registered trademark of Beckhoff Automation GmbH.

# Position Control Unit

## CJ1W-NC271/471/F71 – MECHATROLINK-II

Quick Link

F426

omron247.com

### Multi-axis point-to-point positioning controller over MECHATROLINK-II Motion Bus

- Position control units with 2, 4 or 16 axes
- High-speed bus MECHATROLINK-II is specially designed for motion control
- Supports position, speed and torque control
- Programming languages: ladder, function blocks. Supports PLC Open Function Blocks
- Smart active parts for OMRON HMIs reduce engineering time
- Access to the complete system from one point. Network setup, servo drives configuring and monitoring, and PLC programming
- Installs on compact, high-speed CJ2 and CJ1 PLCs

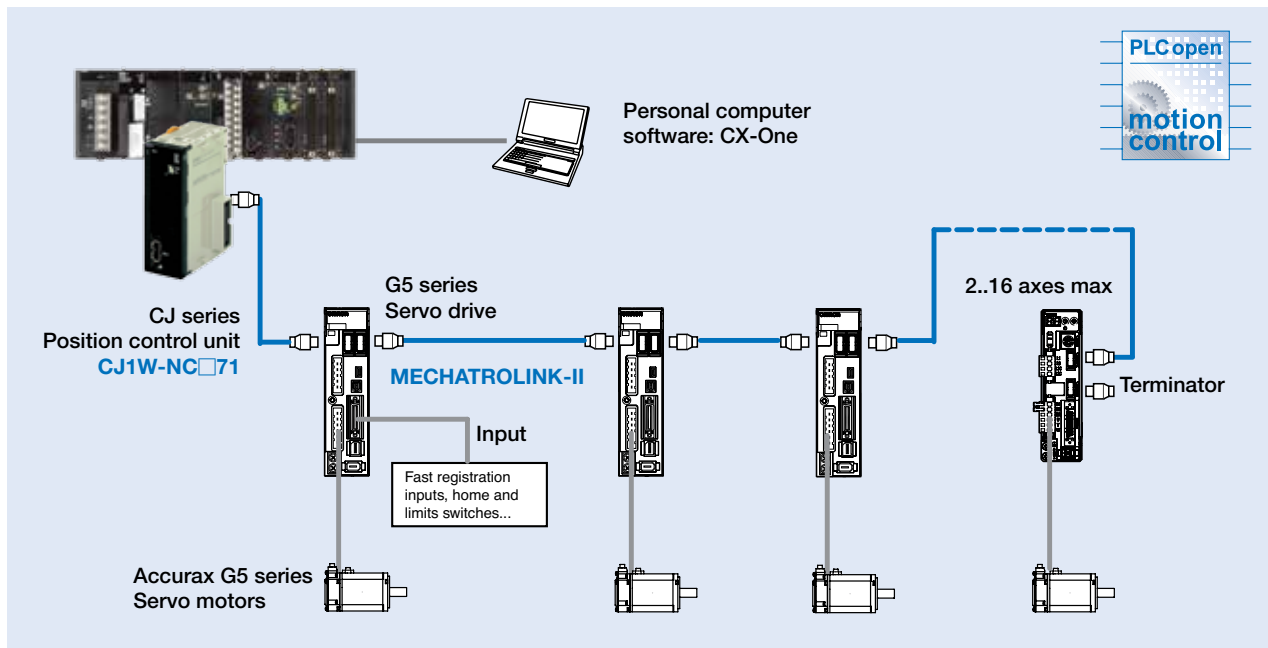

F

# Motion Control Unit

## CS1/C200HW-MC402-E

Quick Link

F427

omron247.com

### Advanced multi-axes motion control made perfectly intuitive

- Advanced motion control of 4 real axes and 4 virtual axes per unit. Up to 16 modules can be installed in one PLC
- Analog outputs for CS1-series close loop position and speed control
- Simple to develop and modify using BASIC
- Multi-task programming
- Friendly Motion Perfect, Windows-based programming and debugging software. Provides versatile test and monitoring functions including a 4-channel software oscilloscope
- Hardware registration input for every axis
- Electronic CAM profiles and axes synchronization



### Function

The advanced motion control unit provides closed-loop control of up to 4 axes, it is programmed in a multi-task BASIC type language and supported by the powerful software tool. The unit provides a complete command set, allowing applications such as flying saws, rotating knives, any synchronization and electronic CAM profile to be easily programmed.

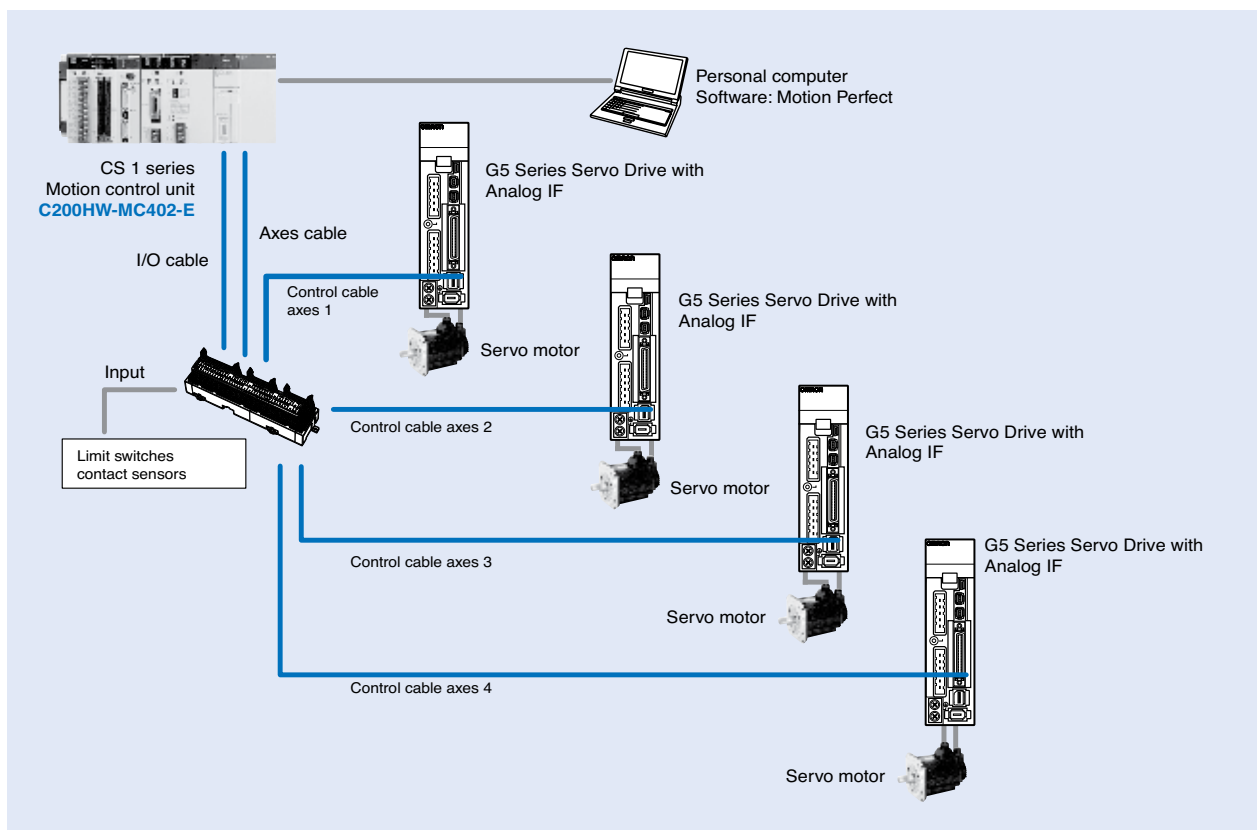

### High-precision motion controller with multi-tasking G-language programming

- High-speed control of up to 4 axes with one unit and up to 76 axes with one PLC (19 units x 4 axes) (assumes that power supply unit capacity is not exceeded)
- Winding operations easily controlled at high-speed using traverse positioning control
- High-speed response to commands from CPU unit (8 ms for 2 axes, 13 ms for 4 axes)
- Encoder response of 2M PPS possible with 4x frequency multiplication for applications with high-speed, high-precision servo motors
- D interrupt code outputs to CPU unit at end of positioning or at specified positions (D code output time: 3.3 ms max)
- CX-Motion Windows-based support software define user mnemonics to use in place of G codes to simplify MC program development and analysis
- Servo trace function from CX-Motion to trace error counter changes or motor speeds
- Automatic loading function. MC programs and positioning data can be automatically downloaded from computer memory when required by the MC unit



### Function

The motion controller provides closed-loop motion control via analog outputs for up to 4 axes, and supports the G language for advanced, high-speed, high-precision position control. Multi-tasking allows you to run the axes independently for a wider range of application.

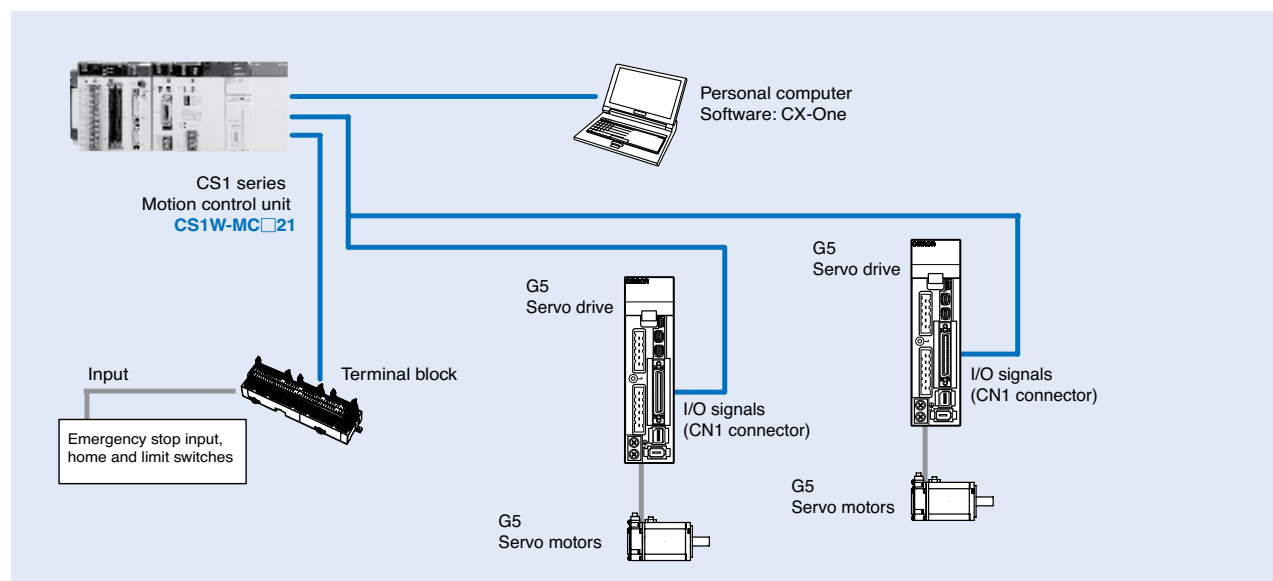

F

### Advanced multi-axis position control made perfectly intuitive

- Position control units with 1, 2 or 4 axes
- Positioning can be done by direct ladder commands
- Position and speed control to CJ-series PLCs
- Linear interpolation
- Interrupt feeding function
- Positioning of 100 points done from memory
- S-curve acceleration/deceleration, origin search, backlash compensation, and other features are also supported
- Positioning data is saved in internal flash memory, eliminating the need to maintain a backup battery



- Use Windows-based support software (CX-Position) to easily create positioning data and store data and parameters in files

### Function

These position control units support positioning control via pulse-train outputs. Positioning is performed using trapezoidal or S-curve acceleration and deceleration. Models are available with 1, 2 or 4 axes control, and can be used in combination with servo drives or stepping motors what accept pulse-train control.

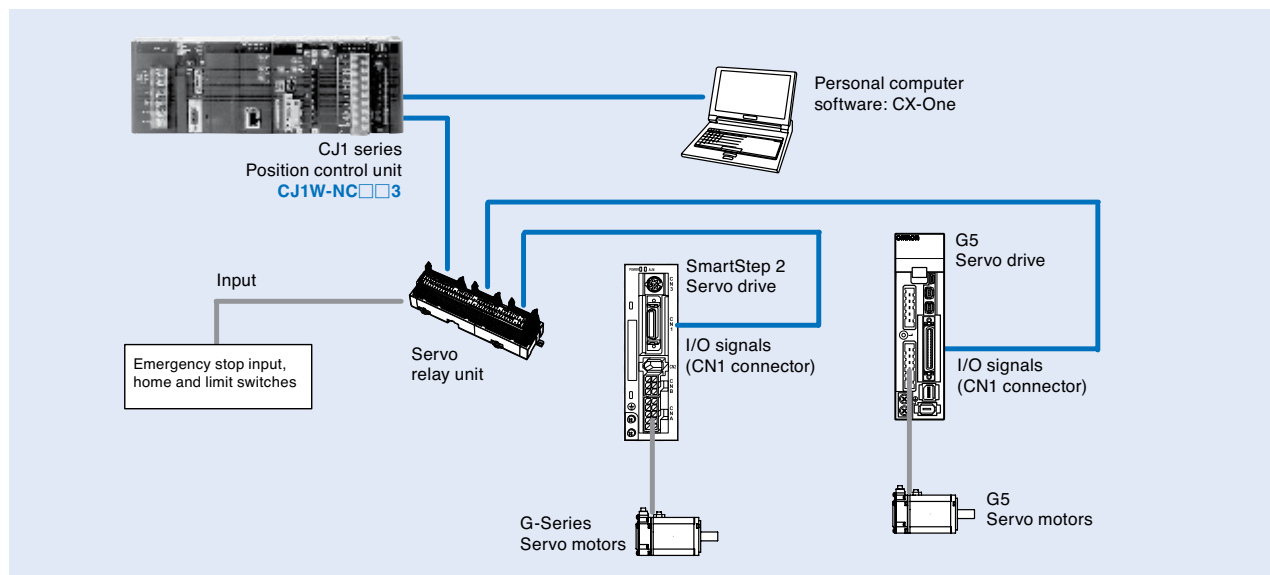

## Point-to-point positioning controller with pulse train output

- Position control units with 1, 2 or 4 axes
- Positioning can be done by direct ladder commands
- Position and speed control
- Linear interpolation
- Interrupt feeding function
- Positioning of 100 points done from memory
- S-curve acceleration/deceleration, origin search, backlash compensation, and other features are also supported
- Positioning data is saved in internal flash memory, eliminating the need to maintain a backup battery



- Use Windows-based support software (CX-Position) to easily create positioning data and store data and parameters in files

## Function

These position control units support positioning control via pulse-train outputs. Positioning is performed using trapezoidal or S-curve acceleration and deceleration. Models are available with 1, 2 or 4 axes control, and can be used in combination with servo drives or stepping motors that accept pulse-train control.

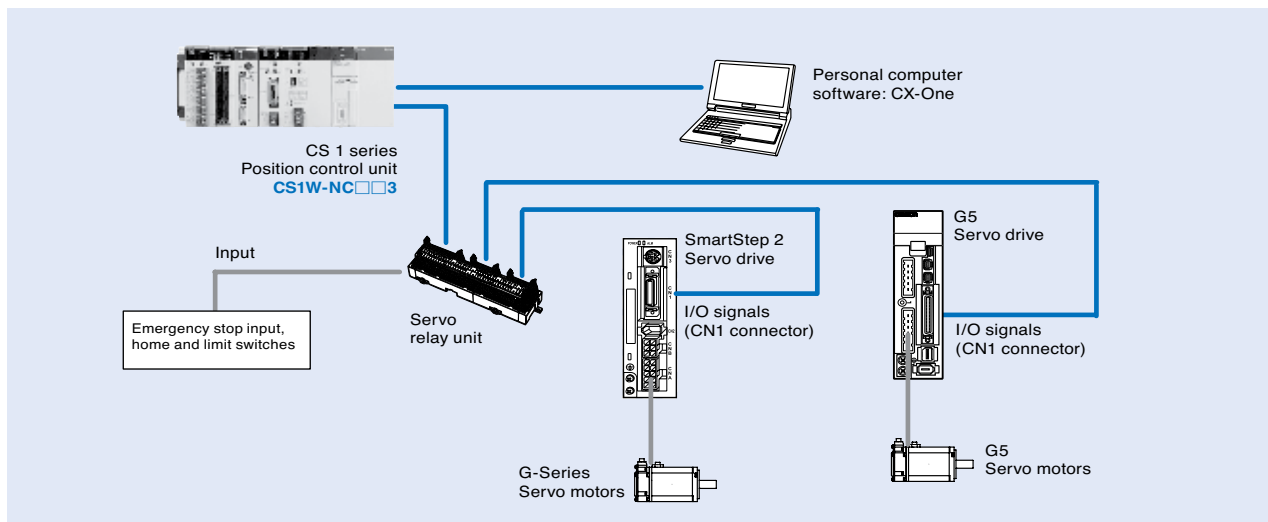

F

## Easy-to-use Stand-alone Cam Positioner with Encoder Input

- High-speed operation at 1600 r/min. and high precision settings to 0.5°
- Advanced angle compensation function compensates for output delays
- Highly visible display with reverse-lit LCD for long-distance legibility
- Fits a 1/4 DIN panel cutout
- Front panel and surface/DIN rail mounting models (track mounting adapter optional)
- 8, 16 and 32 outputs models
- Bank function for multi-product production (8 banks)
- IP40 front panel rating; waterproof and protective covers available



Use Omron absolute encoders for cam input; available with easy-to-install connector

- E6CP-AG5C-C 256 2M for 256 pulse/rev resolution
- E6C3-AG5C-C 360 2M for 360 pulse/rev resolution
- E6F-AG5C-C 720 2M for 720 pulse/rev resolution

## Specifications

- Supply voltage: 24 VDC
- Inputs: Encoder input: Connection to a dedicated absolute encoder
- External inputs: bank inputs 1/2/4, origin input, start input (16-/32-output models)
- Control output:
- 8-output Models: 8 cam outputs, 1 RUN output, 1 pulse output
- Dimensions: 96 H x 96 W x 65 D mm
- 16-output Models: 16 cam outputs, 1 RUN output, 1 pulse output
- 32-output Models: 32 cam outputs, 1 RUN output, 1 pulse output
- Output ratings:
  - Cam outputs, RUN output: NPN or PNP open collector, 100 mA at 30 VDC
  - Pulse outputs: NPN or PNP open collector, 30 mA at 30 VDC

## Ordering Information

Number of outputs	Mounting method	Dimensions L x W x H mm	Output type	Bank function	Model
8 outputs	Panel mounting	96 x 96 x 67.5	NPN open collector	None	H8PS-8B
			PNP open collector		H8PS-8BP
	DIN rail or surface mounting	96 x 96 x 60.6	NPN open collector		H8PS-8BF
			PNP open collector		H8PS-8BFP
16 outputs	Panel mounting	96 x 96 x 67.5	NPN open collector	None	H8PS-16B
			PNP open collector		H8PS-16BP
	DIN rail or surface mounting	96 x 96 x 60.6	NPN open collector		H8PS-16BF
			PNP open collector		H8PS-16BFP
32 outputs	Panel mounting	96 x 96 x 67.5	NPN open collector	None	H8PS-32B
			PNP open collector		H8PS-32BP
	DIN rail or surface mounting	96 x 96 x 60.6	NPN open collector		H8PS-32BF
			PNP open collector		H8PS-32BFP



## Contents

Selection Guide		G-ii
<b>Servo Drives</b>		
R88D-KN R88D-KT	G5 Drives provide high response and high accuracy for a wide variety of applications	G-2
R88D-KN-L R88D-KT-L	G5 Linear Drive and Motors	G-3
R7D-B	SmartStep2 Servo Drives offers advanced servo functionality in a compact design	G-4
<b>Servo Motors</b>		
R88M-K	G5 Servo Motors for high response, high speed and high torque	G-4
R88M-G	G-Series Servo Motors provide high-precision positioning with SmartStep2 servo drives	G-6

## COMPACT PERFORMANCE SERVO SYSTEMS

Great machines are born from a perfect match between control and mechanics. Omron servos give you the extra edge to build more accurate, faster, smaller and safer machines. With the G5 series, you will achieve sub micron precision and ms settling time. Some might call it perfection, we just call it tireless innovation to help you build great machines.

### Scalable Machine Solutions—Servo Drives

#### X-Stream:

- EtherCAT



#### Mainstream:

- EtherCAT
- Analog/Pulse train



#### Lean:





- Pulse train

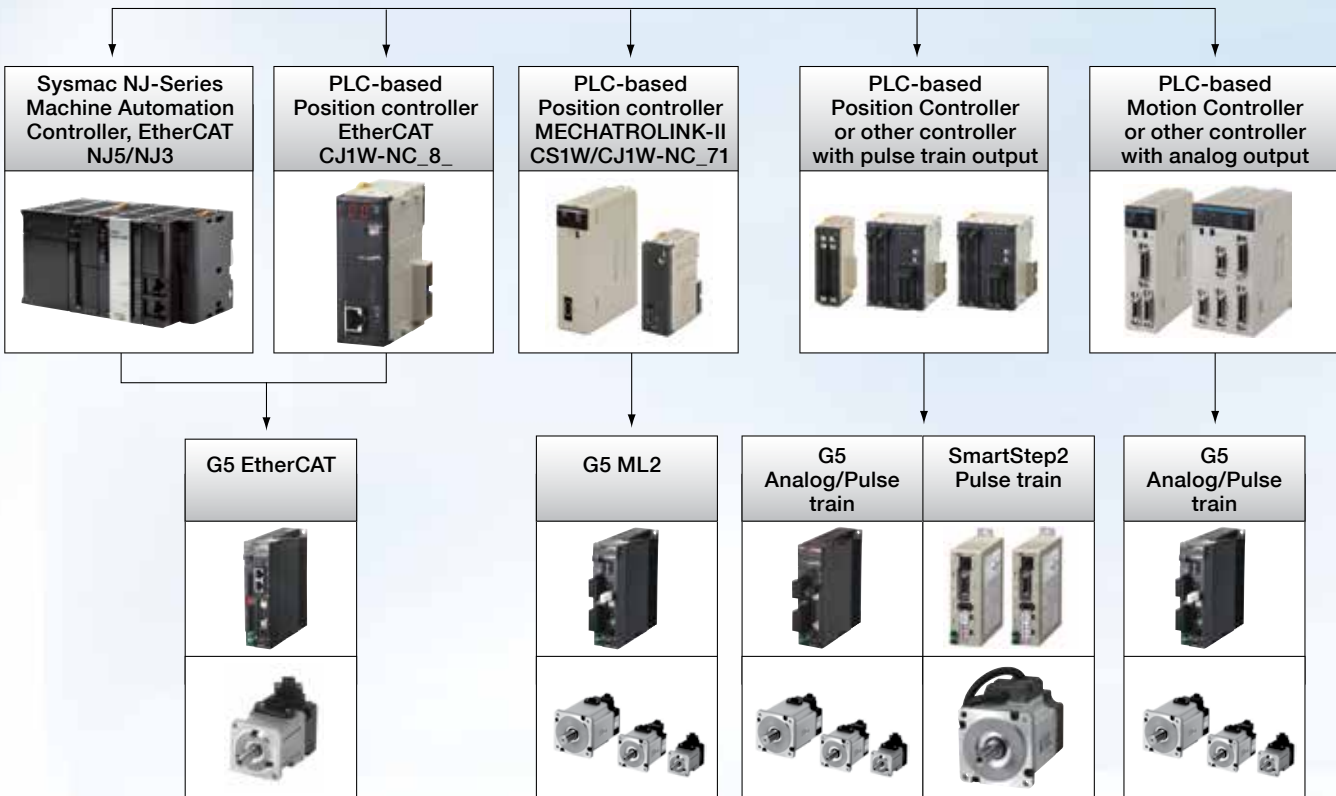





Which motion controller is used?



# Selection Table

Type	Servo Drives			
				
Model	G5 (R88D-KN_-ECT)	G5 (R88D-KN_-ML2)	G5 (R88D-KT)	SmartStep2 (R7D-B)
Command Interface	EtherCAT	MECHATROLINK-II	Analog/Pulse train	Pulse train
Ratings	110 VAC, 1-phase	50 W to 400 W	50 W to 400 W	50 W to 200 W
	230 VAC, 1-phase	100 W to 1.5 kW	100 W to 1.5 kW	50 W to 400 W
	230 VAC, 3-phase	2 kW to 7.5 kW	2 kW to 5 kW	50 W to 400 W
	480 VAC, 3-phase	750 W to 15 kW	750 W to 5 kW	N/A
Applicable servo motor	G5 3rd party (-L versions)	G5	G5	G-Series motors
Position control	EtherCAT (Csp,Pp, Hm)	MECHATROLINK-II Position	Pulse train	Pulse train
Speed control	EtherCAT(Csv)	MECHATROLINK-II Speed	Analog +/- 10V or 8 internal set speeds	4 internal set speeds
Torque control	EtherCAT (Cst)	MECHATROLINK-II Torque	Analog +/- 10V	N/A
Safety approvals	Safe Torque OFF, ISO 13849-1:2008 (PL D), EN 954-1:1996 (Cat 3)	Safe Torque OFF, ISO 13849-1:2008 (PL D), EN 954-1:1996 (Cat 3)	Safe Torque OFF, ISO 13849-1:2008 (PL D), EN 954-1:1996 (Cat 3)	
Full closed loop	Built-in	Built-in	Built-in	

Type	G5 Servo Motors			G-Series Servo Motors Cylindrical Type	G-Series Servo Motors Flat Type
					
	3000 r/min motor	1500 & 2000 r/min motor	1000 r/min motor	3000 r/min motor	3000 r/min motor
Rated speed	3,000 rpm	1,500 and 2,000 rpm	1,000 rpm	3,000 rpm	3,000 rpm
Maximum speed	4,500 & 6,000 rpm	2,000 & 3,000 rpm	2,000 rpm	5,000 rpm	5,000 rpm
Rated torque	0.16 Nm to 15.9 Nm	1.91 Nm to 95.9 Nm	8.59 Nm to 57.3 Nm	0.16 Nm to 1.3 Nm	0.32 Nm to 1.3 Nm
Sizes	50 W to 5 kW	400 W to 15 kW	900 W to 6 kW	50 W to 400 W	100 W to 400 W
Applicable servo drive	G5 servo drive	G5 servo drive	G5 servo drive	G5 Servo Drives and SmartStep2	G5 Servo Drives and SmartStep2
Encoder resolution	20-bit incremental/ 17-bit absolute	20-bit incremental/ 17-bit absolute	20-bit incremental/ 17-bit absolute	10,000 pulses/ revolution	10,000 pulses/ revolution
IP rating	IP67	IP67	IP67	IP65	IP65

Accurate motion control in a compact size servo drive family. EtherCAT or MECHATROLINK-II motion bus and safety built in.

- EtherCAT, MECHATROLINK-II and Analog/Pulse servo drive models
- Safety conforming IEC61800-5-2 (STO), EN 954-1 (CAT3), EN61508 SIL2, and ISO13849-1 (PLc-d)
- Speed loop frequency response of 2 kHz
- High resolution serial encoder for greater accuracy provided by 20 bit encoder
- External encoder input for full close loop
- Real time auto-tuning
- Advanced tuning algorithms (Anti-vibration function, torque feed-forward, disturbance observer)
- Built-in digital I/O includes 2 high speed independent registration inputs



### Ratings

- 120 VAC Single-phase 50 W to 400 W
- 230 VAC Single-phase 100 W to 1.5 kW
- 230 VAC Three-phase 2 kW to 5 kW
- 480 VAC Three-phase 750 W to 15 kW

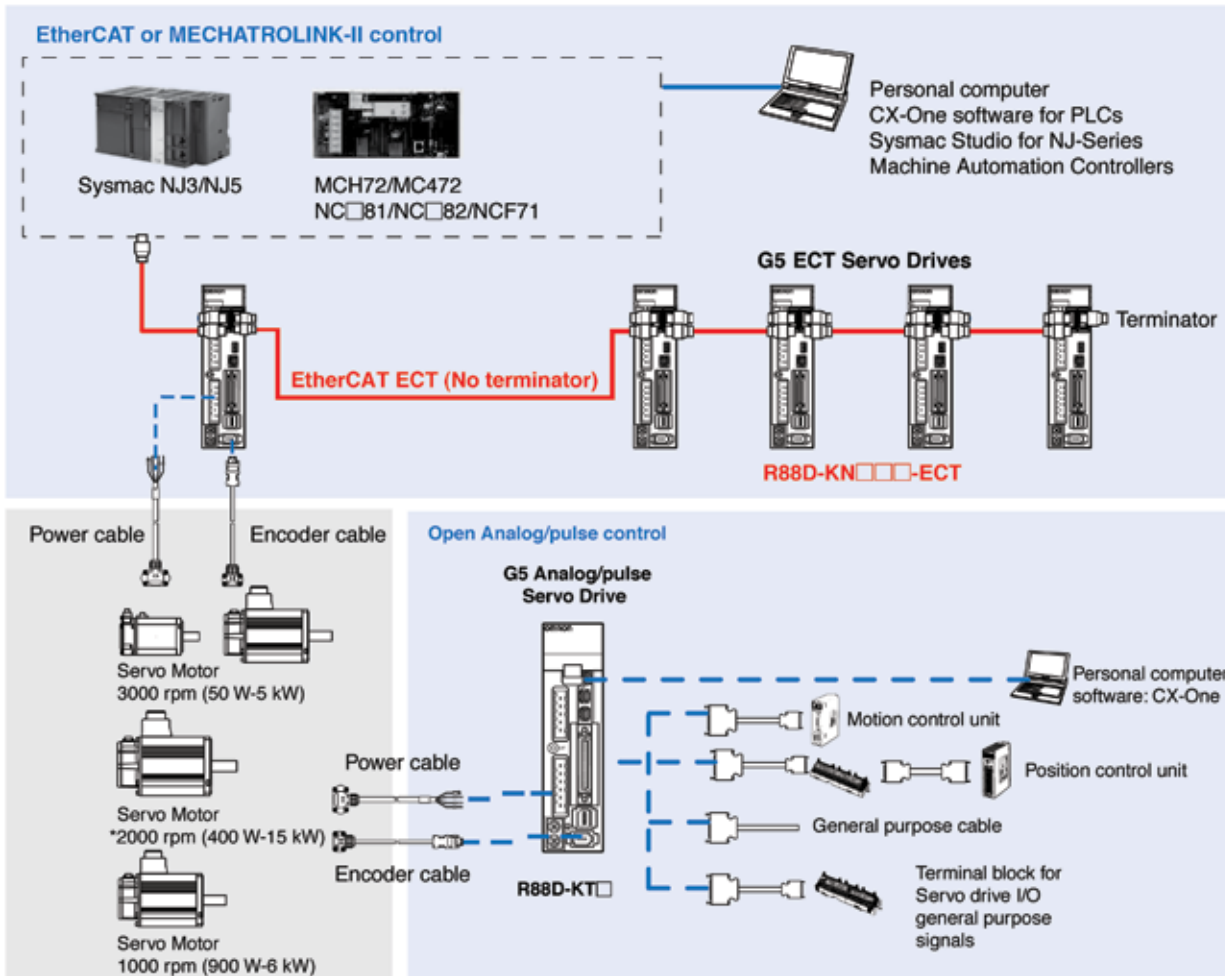

\*7.5/11/15 kW are 1500 RPM

### Accurate motion control in a compact size servo drive family. EtherCAT and safety built in.

- Ironless and iron-core motor types
- 3rd Party linear and rotary motor control\*
- Safety conforming ISO13849-1 PL-d
- High-response frequency of 2 kHz
- Real time auto-tuning
- Advanced tuning algorithms (vibration suppression, velocity and torque feedforward, friction compensation, disturbance observer)

\*with supported encoders



### Ratings

- Iron-core motors - 48 to 760 N (2000 N peak force)
- Ironless motors - 29 to 423 N (2100 N peak force)
- 110V from 100W to 0.4 kW
- 230V single phase from 100W to 1.5 kW
- 230V three phase from 2 kW to 15 kW
- 400V from 600W to 15 kW

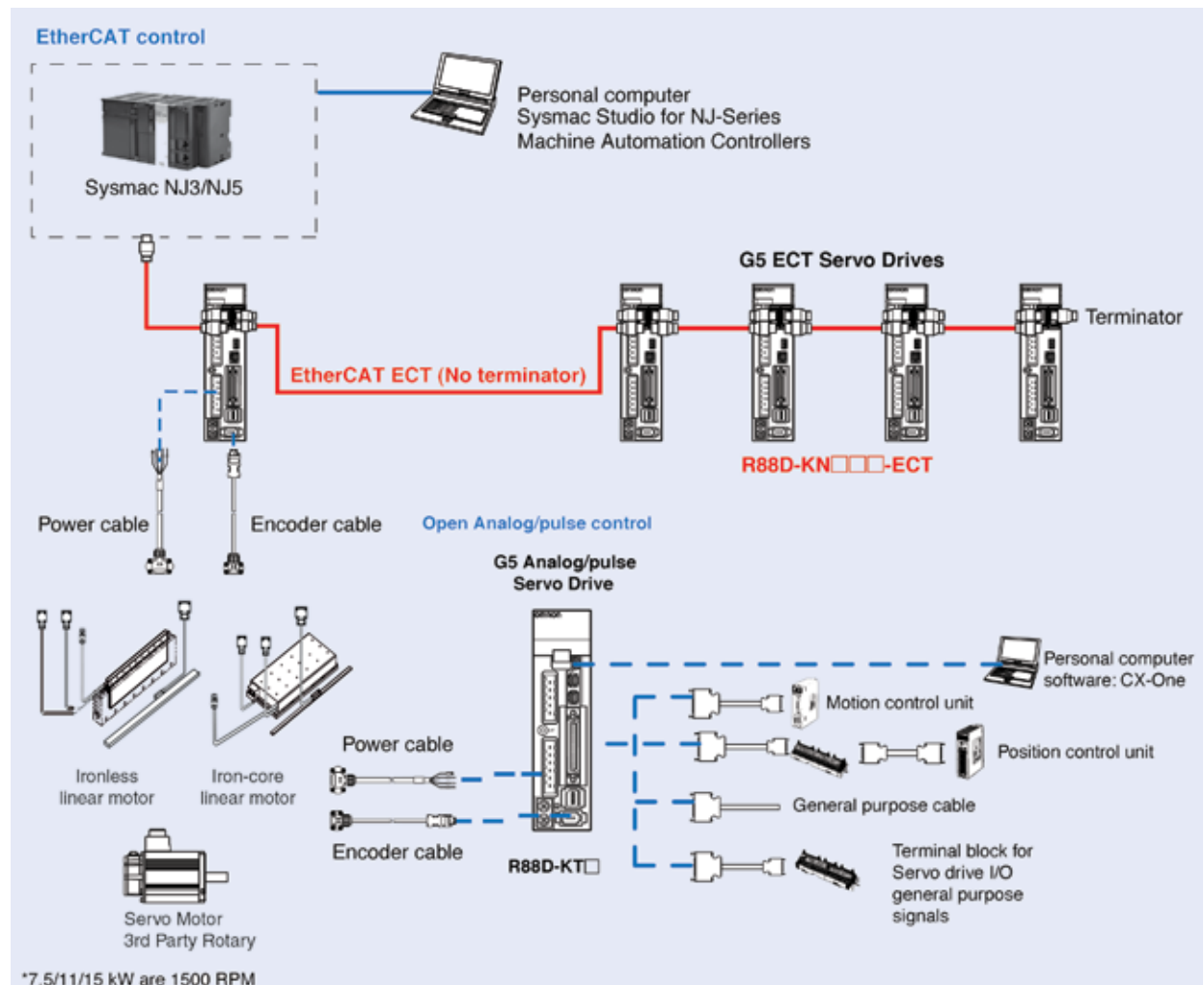

### Another step forward in drive simplicity.

- On-line auto-tuning and easy set-up
- Ultra-compact size. The footprint is only 48% that of the SmartStep series
- Two torque limit settings
- Electronic gear, four internal speed settings and wide range of pulse settings
- Adaptive filters for suppression of vibration and resonance
- Configuration and commissioning using CX Drive-software

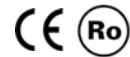

### Ratings

- 120 VAC single-phase 50 W to 200 W
- 230 VAC Single-phase 50 W to 400 W
- 230 VAC three-phase 50 W to 400 W

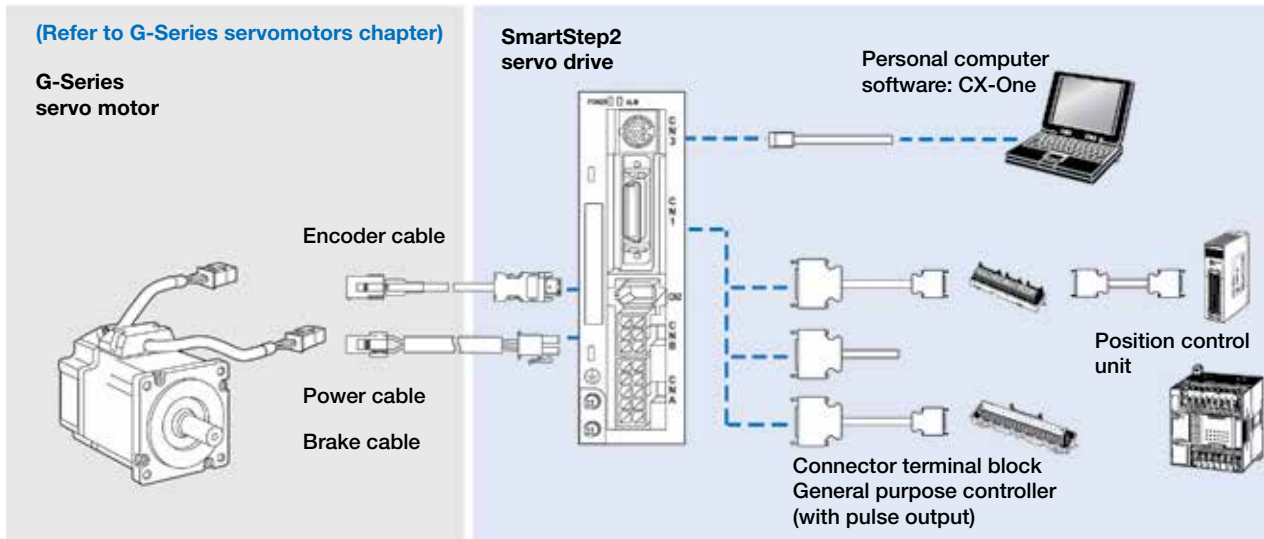

### Servo family for accurate motion control. High response, high speed and high torque.

- Peak torque 300% of rated torque for 3 seconds or more depending on model
- High resolution 20 bit encoder enables precise and accurate motor control
- IP67 protection in all models
- Ultra-light and compact size motor
- Low speed ripple and low torque ripple due to low torque cogging
- Various shaft, brake and seal options



### Ratings

- 120 VAC from 50 W to 400 W
- 230 VAC from 50 W to 7.5 kW
- 480 VAC from 400 W to 15 kW

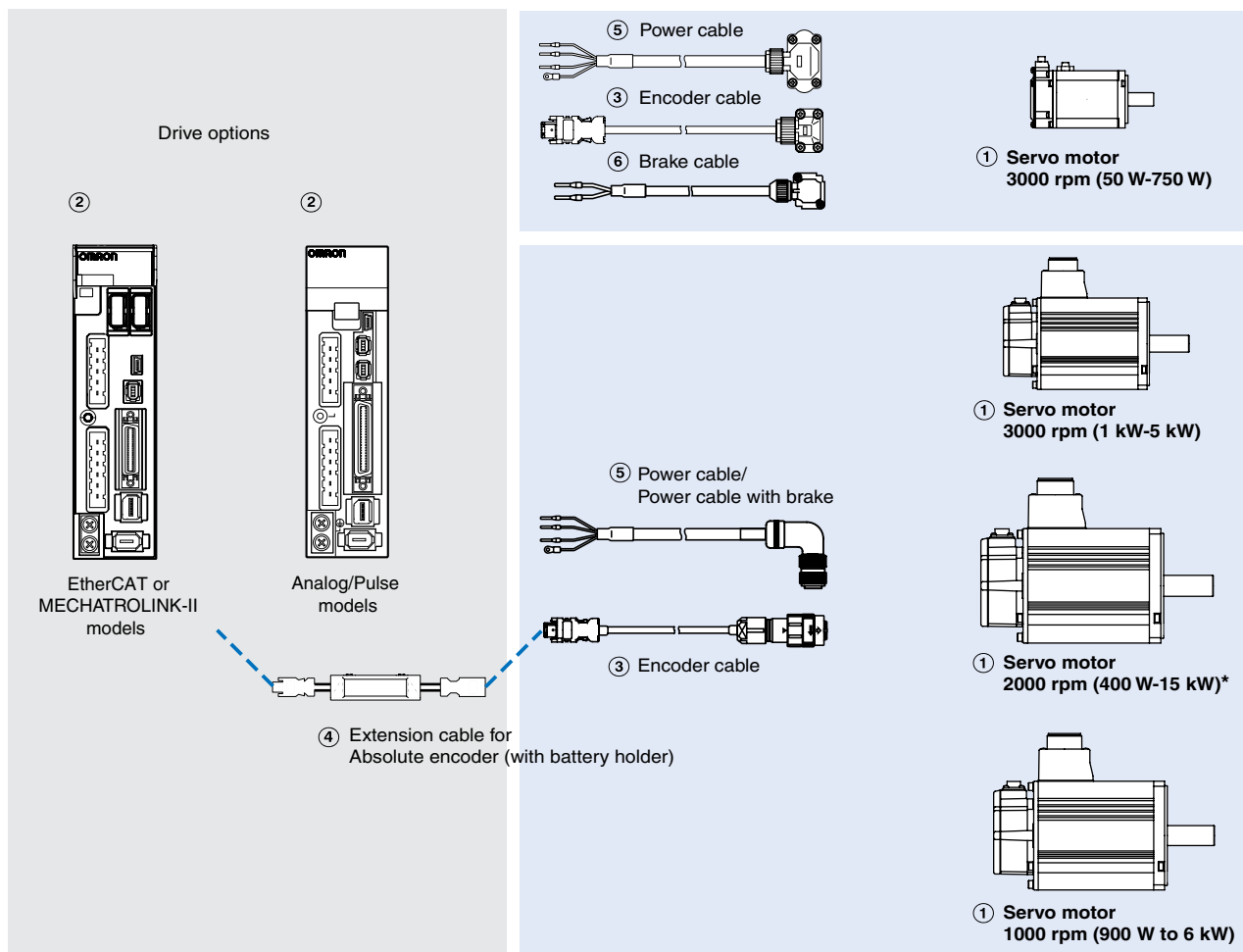

**Note:** The symbols ①②③... show the recommended sequence to select the servo motor and cables.

\* 7.5/11/15kW are 1500 RPM

### A wide range of compact servomotors to meet all application needs

- Peak torque 300% of continuous torque for 3 seconds or more depending on model
- Servomotors supported by SmartStep2, and G5 servo drives
- Cylindrical and Flat servomotors types are available
- Encoder accuracy of 10,000 step/rev as standard
- IP65 as standard and shaft oil seal available
- Motors with brake as option



### Ratings

- 120 VAC single-phase 50 W to 200 W
- 230 VAC single-phase 50 W to 400 W
- 230 VAC three-phase 50 W to 400 W

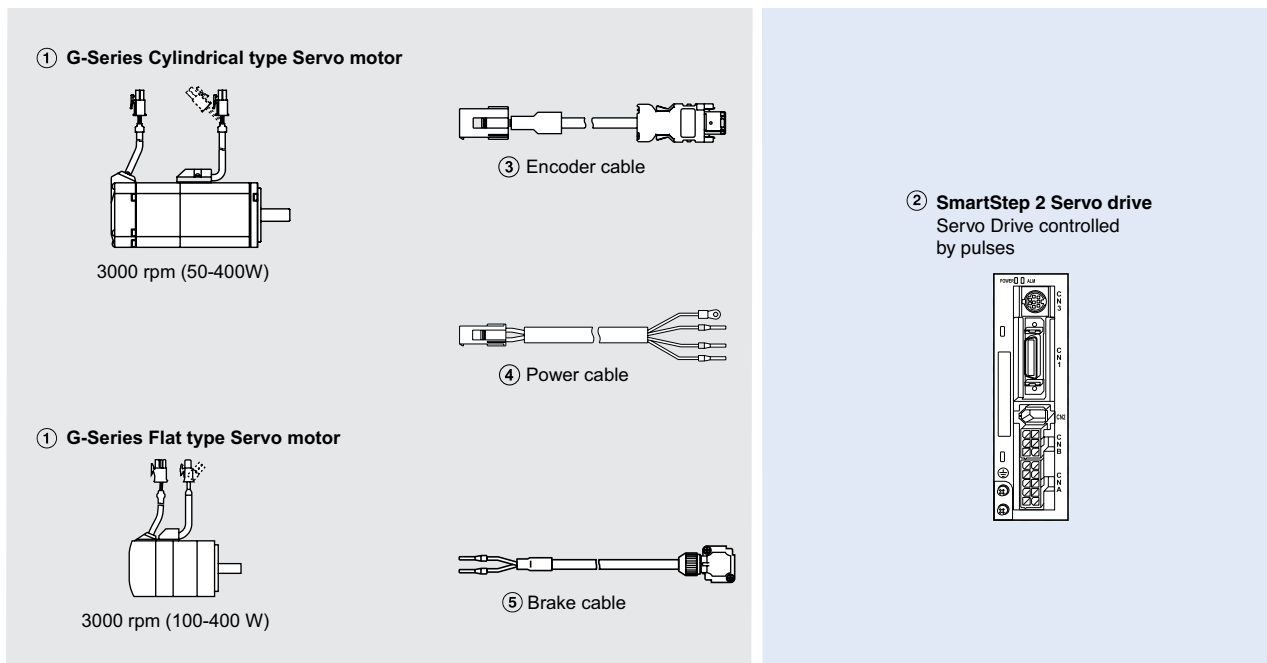

**Note:** The symbols ①③④⑤.... show the recommended sequence to select the servo motor and cables.



## Contents

Selection Guide		H-ii
<b>AC Drives</b>		
3G3JX	V/Hz AC Drive with energy saving function	H-2
3G3MX2	Compact Sensorless vector control AC Drive	H-3
3G3RX	Advanced sensorless or closed loop vector control AC drive	H-4
3G3DV	Advanced sensorless or closed loop vector control AC drive including high power	H-5

## HARMONIZED MOTOR AND MACHINE CONTROL

The 3G3 AC Drives are a family of high performance variable frequency drives suitable for asynchronous induction motors in a variety of industrial applications ranging from conveyors, pumps and fans to winders, mixers, and extruders. Dual rating with high starting torque and built-in EMC filters are among some of the differentiating features.

Ready to integrate with many communication options and built-in safety, the MX2 expands capabilities specifically for machine control as part of a system or a stand-alone device. Basic positioning functionality reduces components and complexity for simple indexing or more advanced packaging machinery.

### Scalable Machine Solutions-Inverters

#### X-Stream:

- V/Hz control
- Sensorless vector control
- Closed loop vector control

#### Mainstream:

- V/Hz control
- Sensorless vector control

#### Lean:

- V/Hz control

RX series	DV series
 Up to 132 kW (175HP)	 Up to 1 MW (1350HP)



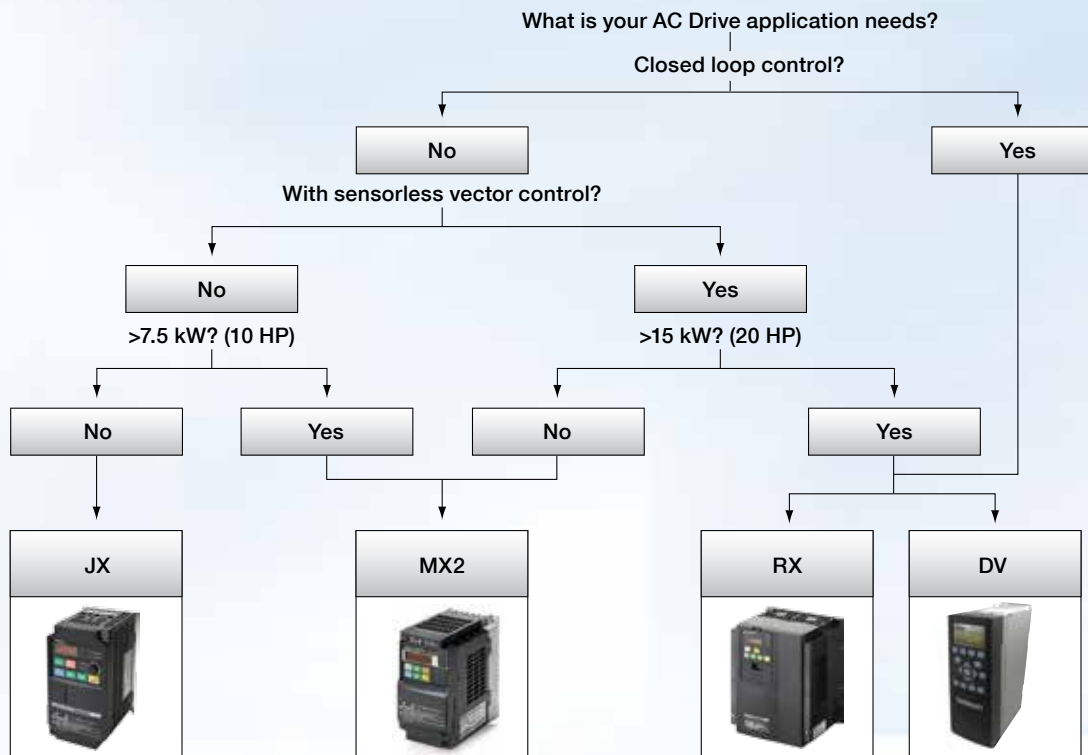

MX2 series
 Up to 15 kW (20HP)

JX series
 Up to 7.5 kW (10HP)



# Selection Table

H

Model	JX	MX2	RX	DV
				
	<b>Compact and complete</b>	<b>Born to drives machines</b>	<b>Customized to your machine</b>	<b>Single solution for any application</b>
230 V, 1-phase	0.2 kW to 2.2 kW (1/4 HP to 3 HP)	0.1 kW to 2.2 kW (1/8 HP to 3 HP) <sup>2</sup>	N/A	N/A
230 V, 3-phase	0.2 kW to 7.5 kW (1/4 HP to 10 HP) <sup>1</sup>	0.1 kW to 15 kW (1/8 HP to 20 HP) <sup>2</sup>	0.4 kW to 55 kW (1/2 HP to 75 HP) <sup>1</sup>	0.25 to 37 kW <sup>1,2</sup> (1/3 to 50 HP)
480 V, 3-phase	0.2 kW to 7.5 kW (1/2 HP to 10 HP) <sup>1</sup>	0.4 kW to 15 kW (1/2 HP to 20 HP) <sup>2</sup>	0.4 kW to 132 kW (1/2 HP to 175 HP) <sup>1</sup>	0.37 to 800 kW <sup>1,2</sup> (1/2 to 1200 HP)
575 V, 3-phase	N/A	N/A	N/A	0.75 to 75 kW <sup>2</sup> (1 to 100 HP)
690 V, 3-phase	N/A	N/A	N/A	90 to 1000 kW <sup>1,2</sup> (125 to 1350 HP)
Control method	V/Hz control	Open loop V/Hz or Sensorless open loop vector control	Open loop V/Hz or Sensorless open loop vector control; Closed loop vector control	Open loop V/Hz or Sensorless open loop vector control; Closed loop vector control
Torque features	• 150% at 3 Hz	• 200% at 0.5 Hz	• 200% at 0.0 Hz (CLV) • 200% at 0.3 Hz (OLV)	• N/A
Connectivity	• Modbus (built-in)	• Modbus (built-in)  Options: • EtherCAT • Ethernet/IP • DeviceNet • CompoNet • PROFIBUS • MECHATROLINK-II	• Modbus (built-in)  Options: • EtherCAT • DeviceNet • PROFIBUS • CompoNet	• Modbus (built-in)  Options: • Ethernet/IP • DeviceNet • PROFIBUS
Logic programming	N/A	Standard Firmware	Standard Firmware	Standard Firmware
Simple positioning	N/A	Open loop	Closed loop	Closed loop
IP/NEMA Ratings	IP20	IP20	IP20	IP00, 20, 21, 54 and 66 NEMA 1, 12, 4 (Available ratings vary by power size)

1. EMC filter built-in

2. Dual rating

## Compact & Complete

- V/Hz controlled inverter
- Side by side mounting
- Built-in Radio Noise Filter (3 phase model only)
- Overload detection function (150% for 60s)
- PID
- Micro-surge voltage suppression
- Automatic energy saving
- Emergency shut-off
- Second motor setting
- Auto carrier-frequency reduction
- PTC thermistor input
- Auxiliary cooling fan control
- PC configuration tool; CX-Drive
- Built-in RS-485 Modbus



## Ratings

- 230 V Class single-phase, 0.2 to 2.2 kW (1/4 to 3 HP)
- 230 V Class three-phase, 0.2 to 7.5 kW (1/4 to 10 HP)
- 480 V Class three-phase, 0.4 to 7.5 kW (1/2 to 10 HP)

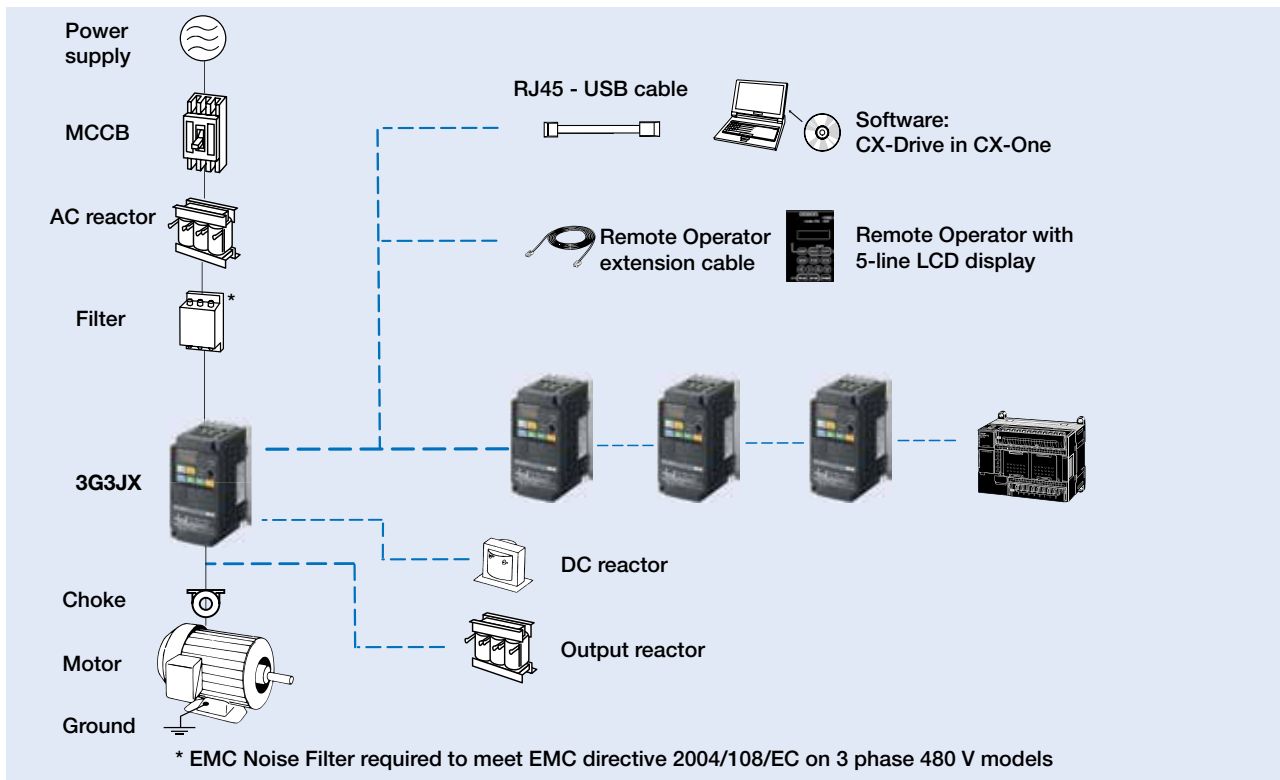

## Born to drive machines

- V/Hz or Sensorless vector control
- High starting torque: 200% at 0.5 Hz
- Dual rated: VT 120% for 1 min and CT 150% for 1 min
- Torque control in sensorless vector
- Simple positioning functionality
- Permanent magnet motor capable
- Easy auto-tuning
- Built-in logic programmability and application functionality
- Safety embedded compliant with ISO13849-1 (double input circuit and external device monitor EDM)
- USB port for PC programming
- PC configuration tool: CX-Drive
- Modbus built in. Options for EtherCAT, EtherNet/IP, DeviceNet, Profibus, CompoNet and MECHATROLINK



## Ratings

- 230 V Class single-phase 0.1 to 2.2 kW (1/8 to 3 HP)
- 230 V Class three-phase 0.1 to 15.0 kW (1/8 to 20 HP)
- 480 V Class three-phase 0.4 to 15.0 kW (1/2 to 20 HP)

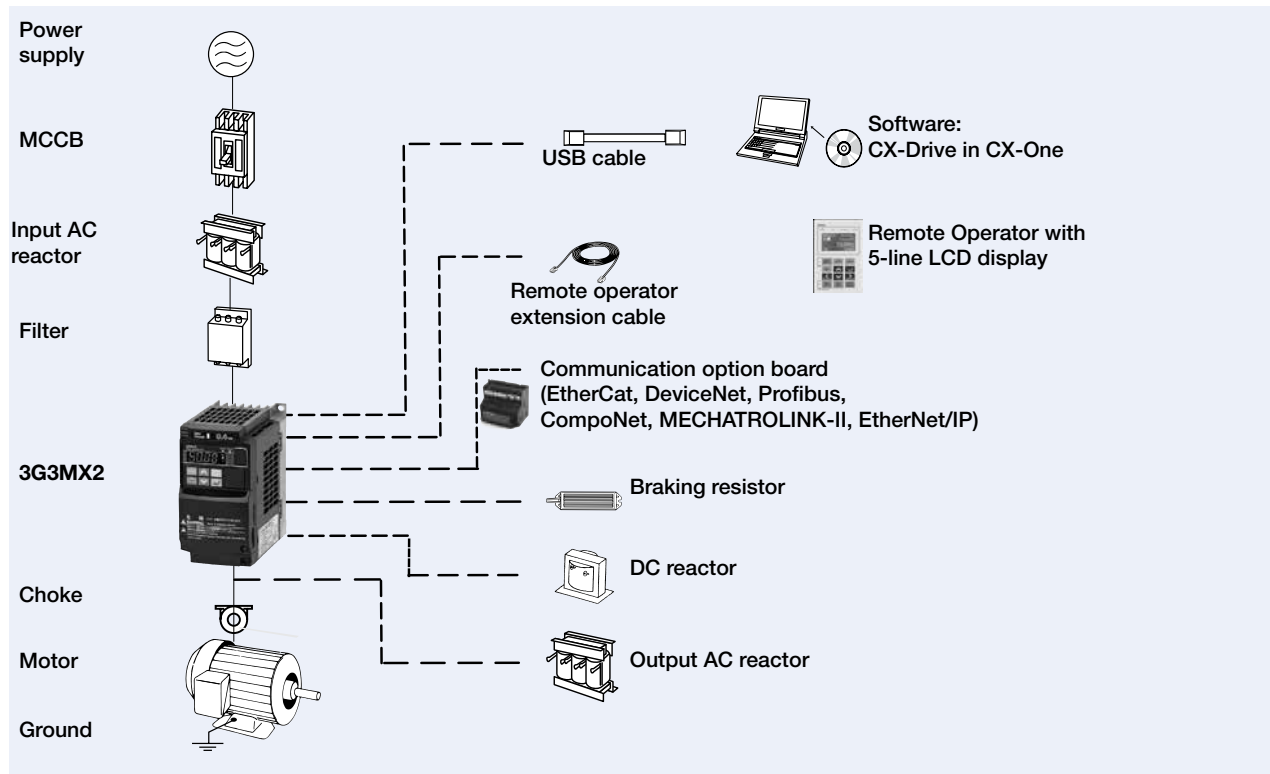

## Customized to your machine

- V/Hz, sensorless vector or closed loop vector control
- High-starting torque in open loop; 200% at 0.3 Hz
- Full torque at 0 Hz in closed loop
- Simple positioning functionality
- Easy auto tuning
- Built-in logic programmability, and application functionality
- Built-in EMC filter
- Automatic energy saving
- Micro-surge voltage suppression
- PC configuration tool: CX-Drive
- Modbus RS485 built in. Options for EtherCAT, DeviceNet, PROFIBUS and CompoNet



## Ratings

- 230 V Class three-phase, 0.4 to 55 kW (1/2 to 75 HP)
- 480 V Class three phase, 0.4 to 132 kW (1/2 to 175 HP)

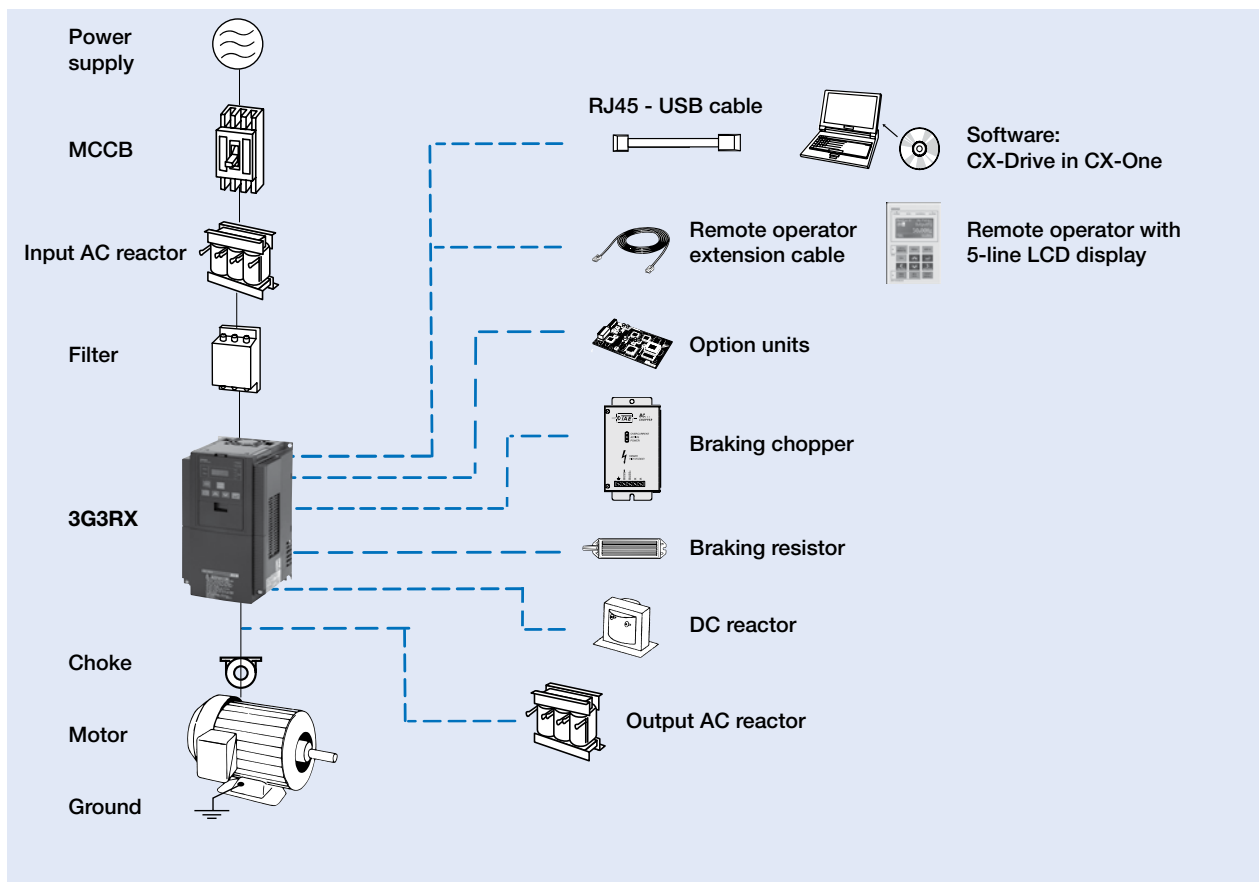

## Single solution for any type of application

- V/Hz, sensorless vector or closed loop vector control
- NEMA1/12/4 - IP00/20/54/55/66 options available
- Dual rated: VT 120% for 1 min and CT 160% for 1 min
- Full torque at 0 Hz in closed loop
- Positioning functionality
- Easy auto tuning
- Built-in logic programmability and application functionality
- Built-in RFI filter and DC link reactor
- Permanent Magnet motor capable
- Automatic energy saving
- Advanced programmable display
- Modbus RS485 Built in. Options for EtherNet/IP, DeviceNet, Profibus
- 24V Incremental Encoder input Built in. Options for RS422, Hyperface, EnDat, SSI and Sinusoidal encoder inputs



## Ratings

- 230 V Class three-phase, 0.25 to 37 kW (1/3 to 50 HP)
- 480 V Class three-phase, 0.37 to 800 kW (1/2 to 1200 HP)
- 575 V Class three-phase, 0.75 to 75 kW (1 to 100 HP)
- 690 V Class three-phase, 90 to 1000 kW (125 to 1350 HP)

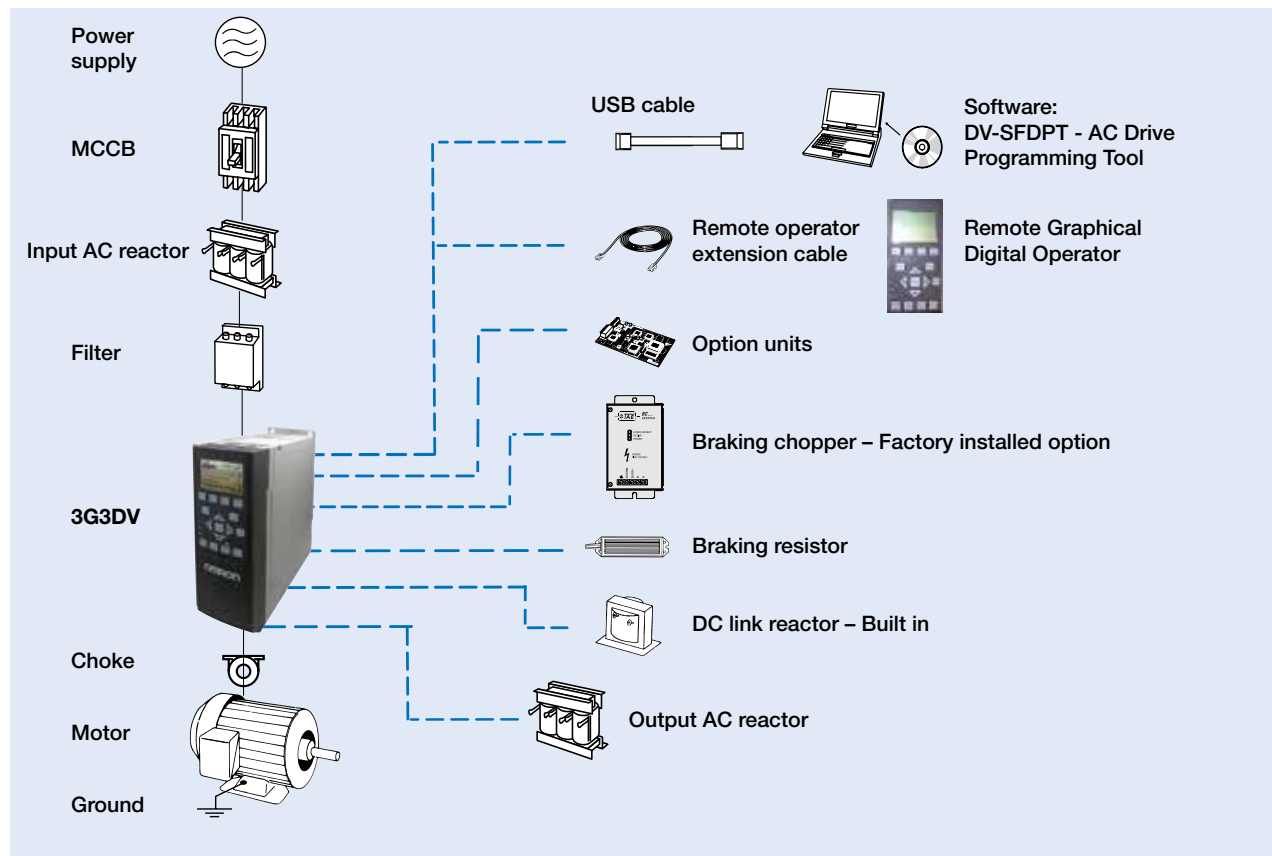





## Contents











Selection Guide	I-ii
<b>Robot Controllers</b>	
Sysmac NJ Series Machine Automation Controller with embedded robotics functionality	I-2
<b>Mechanics</b>	
Sysmac Delta Robot Mechanics	I-3



## DELTA ROBOT SOLUTIONS

Omron's Sysmac NJ Series Machine Automation architecture allows you to design and build high performance Pick and Place machines with unprecedented flexibility and simplicity. The NJ Series Robotics Controller seamlessly integrates PLC logic, Motion control, Vision processing, Safety and Robot kinematics – all with one processor using one development environment. Advanced motion and vision capabilities are easily combined to create high throughput solutions that can not only identify and locate products, but also inspect them simultaneously.



	XL Delta Robot	Washdown Delta Robot	Delta Robot	Mini Delta Robot
Robot	 <ul style="list-style-type: none"> <li>Rated working range: Ø 1300 x 400mm</li> <li>Max. Payload: 2Kg</li> <li>Cycle time 25/305/25 mm (0.1 kg): Up to 120 cycle/min IP65</li> </ul>	 <ul style="list-style-type: none"> <li>Rated working range: Ø 1100 x 450mm</li> <li>Max. Payload: 3Kg</li> <li>Cycle time 25/305/25 mm (0.1 kg): Up to 150 cycle/min IP67 hygienic design</li> </ul>	 <ul style="list-style-type: none"> <li>Rated working range: Ø 1100 x 250mm</li> <li>Max. Payload: 2Kg</li> <li>Cycle time 25/305/25mm (0.1Kg): Up to 150 cycle/min.</li> </ul>	 <ul style="list-style-type: none"> <li>Rated working range: Ø 500 x 155mm / Ø 450 x 135mm (with rotational axis)</li> <li>Max. Payload: 1Kg</li> <li>Cycle time 25/305/25mm (0.1Kg): Up to 200 cycle/min.</li> </ul>
Controller	<p>NJ Robotics, NJ501-4 □□□</p>  <p><b>SYSMAC</b> always in control</p> <ul style="list-style-type: none"> <li>Up to 64 axes motion control</li> <li>Scalable control: CPUs for 16, 32 and 64 axis</li> <li>Up to 8 Delta robots</li> <li>EtherCAT and EtherNet/IP ports embedded</li> <li>Conforms to IEC 61131-3 standards</li> </ul>			
Servo System	<p>G5 Servo Drive</p>  <ul style="list-style-type: none"> <li>High frequency response of 2 KHz</li> <li>Safety conforming to ISO13849-1</li> <li>Advanced tuning algorithms</li> </ul>	<p>G5 Servo Motors</p>  <p><b>Delta</b></p> <ul style="list-style-type: none"> <li>17 bit absolute encoder</li> <li>230 VAC 1kW servo motor with brake</li> <li>Low cogging torque</li> </ul>		 <p><b>Mini Delta</b></p> <ul style="list-style-type: none"> <li>17 bit absolute encoder</li> <li>230 VAC 400W servo motor with brake</li> <li>Low cogging torque</li> </ul>
Vision	<p>FQM Series</p>  <ul style="list-style-type: none"> <li>Camera, vision and connectivity in one</li> <li>Compact vision sensor</li> <li>Designed for high speed pick and place</li> <li>Encoder tracking and smart calibration function</li> <li>Fast and powerful object recognition</li> </ul>	<p>FH Series</p>  <ul style="list-style-type: none"> <li>Stable measurements under changing conditions</li> <li>Wide variety of positioning measurement methods</li> <li>Simple auto calibration</li> <li>Flexible camera installation</li> </ul>		

# NJ Series

## NJ501-4 Machine Automation Controller with Robotics

Quick Link

H246

omron247.com

### NJ Series Machine Automation Controller with Integrated Robotic Functions

The NJ-Series MAC includes capabilities for seamless integration of Logic, Motion, Vision, Safety, Networks, Robotics and Enterprise level control. Selectable models based on application requirements.

- Integrated Delta Robot control solution
- Control of up to 8 Delta robots
- Update time of 1ms (up to 4 robots) / 2ms (5 to 8 robots)
- Built-in Function Blocks for ease of programming in machine or user coordinates
- Powerful limit checks, absolute positioning, inverse Kinematics and conveyor tracking functions
- Automatic workspace limit checking



**SYSMAC**  
always in control



- All the power and benefits of the NJ Machine Automation controller - Combined with robotics
- Integrated Sysmac Studio development environment to develop, commission, tune, debug, trace, and simulate.
- EtherCAT and EtherNet/IP networks built-in

Note: For Sysmac Controller and System Selection Guide, see section A.

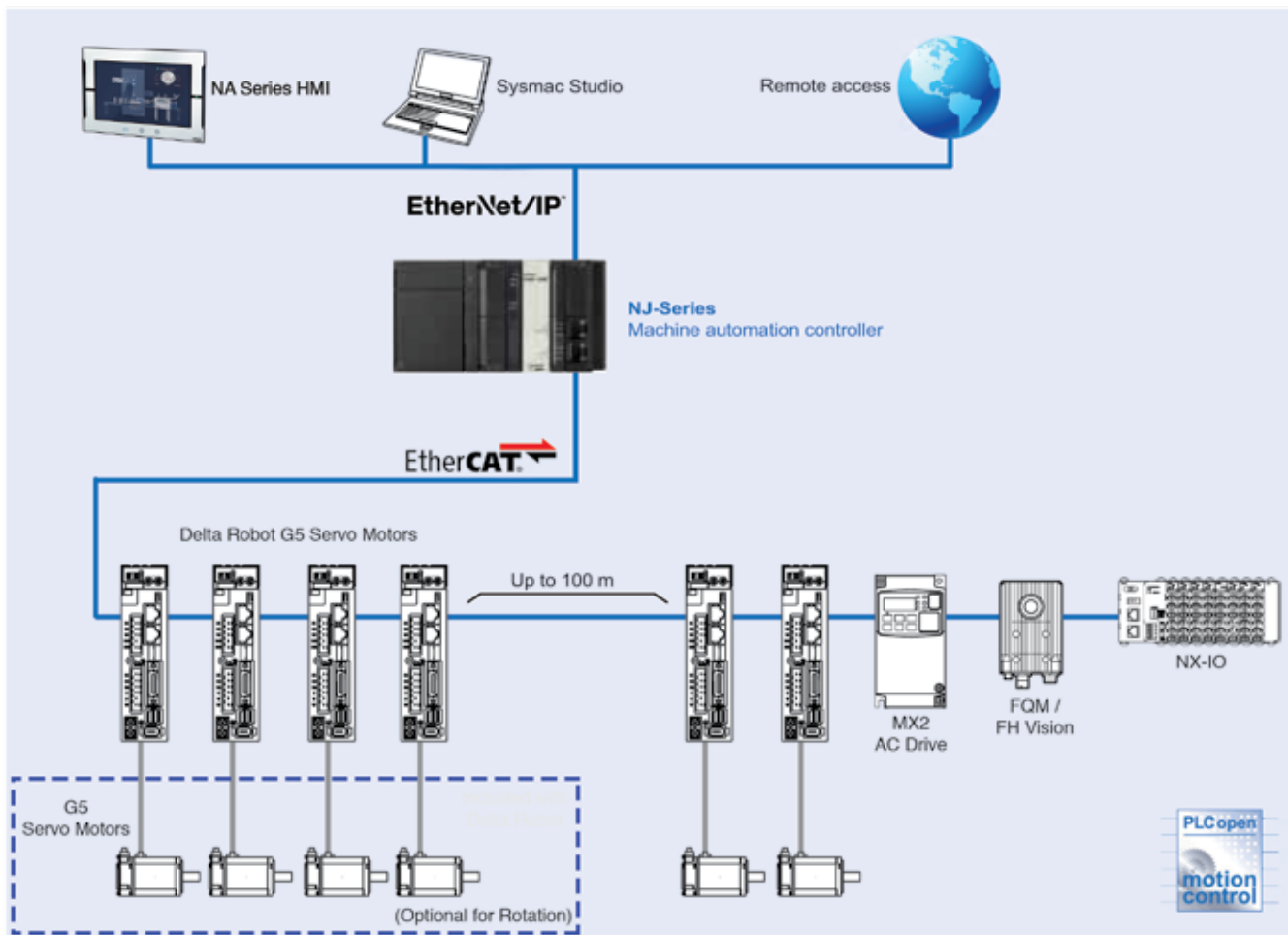

## Delta Robot Mechanics

Ultra-fast Pick & Place system integrated into the Sysmac platform.

- Up to 200 cycles per minute
- Can be synchronized with multiple conveyors
- Update time of 1ms (up to 4 robots) / 2ms (5 to 8 robots)
- Includes pre-installed G5 Servo Motors and gearboxes



## Specifications

	XL Delta	Washdown	Delta Robot	Mini Delta Robot
Axis of motion	3 + 1 (Rotation Optional)	3 + 1 (Rotation Optional)	3 + 1 (Rotation Optional)	3 + 1 (Rotation Optional)
Rated working range (no rotation)	Ø1300 x 400mm	Ø1100 x 450M	Ø1100 x 250mm	Ø500 x 155M
Rated working range (with rotation)	Ø1300 x 400mm	Ø1100 x 450M	Ø1100 x 250mm	Ø450 x 135M
Max. Payload	2Kg	3Kg	2Kg	1Kg
Position Repeatability (X, Y, Z)	± 0.2mm	± 0.2mm	± 0.3mm	± 0.2mm
Angular Repeatability (Rz)	± 0.3 deg	± 0.1 deg	± 0.40	± 0.30
Cycle Time 25/305/25mm (0.1Kg)	120 cycle/min	150 cycle/min	Up to 150 cycle/min	Up to 200 cycle/min
Protection Rating	IP65	IP67	IP55	IP55



## Contents

Selection Guide		J-ii
<b>Photoelectric Sensors</b>		
E3FA/ E3RA	All-application sensor in plastic M18 housing	J-1
E3FB/ E3RB	All-application sensor in metal M18 housing	J-2
E3FC	M18 Stainless Steel for superior environmental resistance	J-3
E3Z	General purpose sensor in compact plastic housing	J-4
E3Z-F	Plastic M18 Mounting on a Rectangular Body	J-5
E3Z-L□	LASER sensor in compact plastic housing	J-6
E3ZM	Detergent-resistant photoelectric sensor in compact stainless steel housing	J-7
E3ZM-C	Oil-resistant photoelectric sensor in compact stainless steel housing	J-8
E3ZM-V	Print mark detection photoelectric sensor in compact stainless steel housing	J-9
E3ZM-B	Transparent PET plastic bottle detection sensor in compact stainless steel housing	J-10
E3Z-B	Transparent bottle detection photoelectric sensor in compact plastic housing	J-11
E3Z-G	Photoelectric sensor in plastic fork shape housing	J-11

E3Z-L	Narrow-beam sensor detects small objects	J-12
E3Z-LS	Miniature distance-settable sensors with built-in amplifiers	J-13
E3Z-K	Oil-resistant sensors	J-14
E3S-CL	Distance-settable photoelectric sensor in metal housing	J-15
E3G	Long distance photoelectric sensor in plastic housing	J-15
E3JM	All voltage (AC/DC) photoelectric sensor, terminal block connection	J-16
E3G-M	Long distance all voltage (AC/DC) photoelectric sensor	J-16
E3T	Photoelectric sensor in miniature plastic housing	J-17
E3S-A	High performance small DC sensors	J-18
E3K	Long Range Universal AC/DC sensors for door control & material handling	J-18
<b>Special Application</b>		
E3NC	Laser position verification sensors with separate digital amplifiers	J-19
E3C-LDA	Variable laser beam sensors with separate digital amplifiers	J-20
F3ET2	Discrete Output Light Grid	J-21
F3EM2	Analog Output Light Grid	J-21
E3S-C	Oil resistant, long distance sensors	J-22
F3UV	UV power monitor for sterilizing and curing operations	J-23
<b>Accessories</b>		
E39-L	Mounting brackets	J-24
E39-R	Reflectors	J-24



## FOR MACHINES THAT NEVER STOP

Omron Automation and Safety's photoelectric sensor range is designed and tested to achieve the maximum levels of reliability and detection performance. Leveraging the latest technology, our sensors ensure your machines never stop.



Through-beam

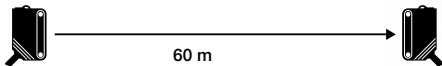

Retroreflective with MSR (Mirror Surface Rejection)

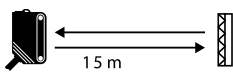

MSR (Mirror Surface Rejection) is a function of Retroreflective Photoelectric Sensors to receive only the light reflected from the Retroreflector by using the characteristics of the polarizing filter built into the Sensor and the characteristics of the Retroreflector.

Diffuse-reflective

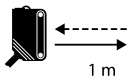

Distance-settable with background suppression

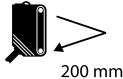

### Compact square plastic housing

#### E3Z



- Highest water resistance
- Highest electromagnetic noise immunity (e.g. from inverters)
- Pulse synchronization for reliable ambient light immunity

### Special Applications

Precision positioning and detection	Detergent resistant	Oil resistant, metal housing	Oil resistant, plastic housing	Print mark detection	Transparent material detection	Transparent bottle detection
<b>E3Z Laser</b>	<b>E3ZM</b>	<b>E3ZM-C, E3S-C</b>	<b>E3Z</b>	<b>E3ZM-V</b>	<b>E3ZM-B</b>	<b>E3Z-B</b>
Small visible light spot	Detergent resistant stainless steel housing	Oil resistance in stainless steel housing (E3ZM-C) or long distance detection (E3S-C)	Oil resistant in plastic housing	Autoteach button and 50 $\mu$ s response time	General transparent materials or PET optimized models	Transparent bottle optimized optical system



Miniature housing:

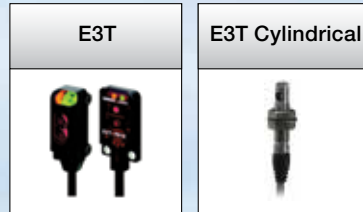



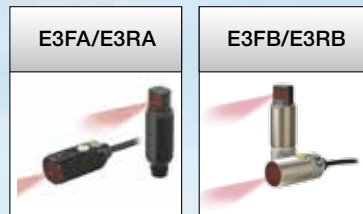



Cylindrical M18 housing:



Longer distance:



**Special Applications**

Fork sensor	Narrow beam sensor	Distance settable sensor	Multi-voltage power supply	High performance, small sensor	Long range sensor	UV power monitor
						
E3Z-G	E3Z-L	E3Z-LS	E3JK, E3JM, E3G-M	E3S-A	E3K	F3UV
Slot width 25 mm for Registration Mark and Edge Control	Detects 0.1 mm diameter objects	Background/foreground suppression sensor (BGS/FGS)	AC/DC power supply and relay output	Timer, alarm, turbo aiming models	Material handling, door control and heavy duty switching applications	Monitor ultraviolet light (UV) intensity or wavelength
			AC/DC			





# Selection Table





					
Model	E3FA/E3RA	E3FB/E3RB	E3FC	E3Z	E3Z-F
Product type	Cylindrical plastic	Cylindrical brass	Cylindrical Stainless Steel	General purpose	Rectangular M18 plastic
Sensor type	<ul style="list-style-type: none"> <li>• Through-beam</li> <li>• Retro-reflective</li> <li>• Diffuse</li> <li>• Background suppression</li> <li>• Limited distance</li> <li>• Transparent detection</li> </ul>	<ul style="list-style-type: none"> <li>• Through-beam</li> <li>• Retro-reflective</li> <li>• Diffuse</li> <li>• Background suppression</li> <li>• Limited distance</li> <li>• Transparent detection</li> </ul>	<ul style="list-style-type: none"> <li>• Through-beam</li> <li>• Retro-reflective</li> <li>• Diffuse</li> <li>• Background suppression</li> </ul>	<ul style="list-style-type: none"> <li>• Through-beam</li> <li>• Retro-reflective</li> <li>• Diffuse</li> <li>• Distance-settable (BGS)</li> </ul>	<ul style="list-style-type: none"> <li>• Through-beam,</li> <li>• Retro-reflective,</li> <li>• Diffuse</li> </ul>
Maximum sensing distances	<ul style="list-style-type: none"> <li>• Through-beam: 20 m</li> <li>• Retro-reflective: 4 m</li> <li>• Diffuse: 1 m</li> <li>• Background suppression: 200 mm</li> <li>• Limited distance: 50 mm</li> <li>• Transparent detection: 2 m</li> </ul>	<ul style="list-style-type: none"> <li>• Through-beam: 20 m</li> <li>• Retro-reflective: 4 m</li> <li>• Diffuse: 1 m</li> <li>• Background suppression: 200 mm</li> <li>• Limited distance: 50 mm</li> <li>• Transparent detection: 2 m</li> </ul>	<ul style="list-style-type: none"> <li>• Through-beam: 20 m</li> <li>• Retro-reflective: 4 m</li> <li>• Diffuse: 1 m</li> <li>• Background suppression: 200 mm</li> </ul>	<ul style="list-style-type: none"> <li>• Through-beam: 30 m</li> <li>• Retro-reflective: 4 m</li> <li>• Diffuse: 1 m</li> <li>• Distance-settable: 200 mm</li> </ul>	<ul style="list-style-type: none"> <li>• Through-beam: 20 m</li> <li>• Retro-reflective: 4 m</li> <li>• Diffuse: 1 m</li> </ul>
Supply voltage	10-30 VDC	10-30 VDC	10-30 VDC	12-24 VDC	10-30 VDC
Output type	Light-on/Dark-on Selectable	Light-on/Dark-on Selectable	Light-on/Dark-on Selectable	Light-on/Dark-on	Light-on/Dark-on Selectable
Output state	NPN or PNP	NPN or PNP	NPN or PNP	NPN or PNP	NPN or PNP
Connections	Pre-wired, Connector	Pre-wired, Connector	Pre-wired, Connector	Pre-wired, Connector	Pre-wired, Connector
IP rating	IP67, IP69K	IP67, IP69K	IP67, IP68, IP69K	IP67	IP67, IP69K

				
Model	E3Z-LASER	E3Z-L	E3Z-LS	E3Z-G
Product type	Laser	Narrow beam	Distance-settable	Grooved head
Sensor type	<ul style="list-style-type: none"> <li>• Through-beam</li> <li>• Retro-reflective</li> <li>• Distance-settable (BGS)</li> </ul>	<ul style="list-style-type: none"> <li>• Diffuse Reflective</li> </ul>	<ul style="list-style-type: none"> <li>• Distance-settable</li> </ul>	<ul style="list-style-type: none"> <li>• Fixed distance through-beam</li> </ul>
Maximum sensing distances	<ul style="list-style-type: none"> <li>• Through-beam: 60 m</li> <li>• Retro-reflective: 15 m</li> <li>• Distance-settable: 300 mm</li> </ul>	<ul style="list-style-type: none"> <li>• Diffuse reflective: 90 mm</li> </ul>	<ul style="list-style-type: none"> <li>• Distance-settable: 200 mm</li> </ul>	<ul style="list-style-type: none"> <li>• 25 mm</li> </ul>
Supply voltage	12-24 VDC	12-24 VDC	12-24 VDC	12-24 VDC
Output type	Light-on/Dark-on	Light-on/Dark-on	Light-on/Dark-on	Light-on/Dark-on
Output state	NPN or PNP	NPN or PNP	NPN or PNP	NPN or PNP
Connections	Pre-wired, Connector	Pre-wired, Connector	Pre-wired, Connector	Pre-wired, Connector
IP rating	IP67	IP67	IP67	IP64

# Photoelectric Sensors





J

				
Model	E3ZM	E3ZM-C	E3ZM-V	E3ZM-B
Product type	Stainless steel housing; Wash down rated	Oil resistant	Print mark detection	PET bottle detection; stainless steel housing
Sensor type	<ul style="list-style-type: none"> <li>• Through-beam</li> <li>• Retro-reflective</li> <li>• Diffuse</li> <li>• Background suppression</li> </ul>	<ul style="list-style-type: none"> <li>• Through-beam</li> <li>• Retro-reflective</li> <li>• Diffuse</li> <li>• Background suppression</li> </ul>	<ul style="list-style-type: none"> <li>• Diffuse reflective mark sensor</li> </ul>	<ul style="list-style-type: none"> <li>• Retro-reflective</li> </ul>
Maximum sensing distances	<ul style="list-style-type: none"> <li>• Through-beam: 15 m</li> <li>• Retro-reflective: 4 m</li> <li>• Diffuse: 1 m</li> <li>• Background suppression: 200 mm</li> </ul>	<ul style="list-style-type: none"> <li>• Through-beam: 15 m</li> <li>• Retro-reflective: 4 m</li> <li>• Diffuse: 1 m</li> <li>• Background suppression: 200 mm</li> </ul>	<ul style="list-style-type: none"> <li>• Diffuse: 12 mm</li> </ul>	<ul style="list-style-type: none"> <li>• Retro-reflective: 500 mm</li> </ul>
Supply voltage	10-30 VDC	10-30 VDC	10-30 VDC	10-30 VDC
Output type	Light-on/Dark-on	Light-on/Dark-on	Light-on/Dark-on	Light-on/Dark-on
Output state	NPN or PNP	NPN or PNP	NPN or PNP	NPN or PNP
Connections	Pre-wired, Connector	Pre-wired, Connector	Pre-wired, Connector	Pre-wired, Connector
IP rating	IP67, IP69K	IP67, IP69K	IP67, IP69K	IP67, IP69K

				
Model	E3Z-B	E3S-CL	E3G	E3JM
Product type	PET bottle detection; plastic housing	Distance-settable	Long distance	All voltage
Sensor type	<ul style="list-style-type: none"> <li>• Retro-reflective</li> </ul>	<ul style="list-style-type: none"> <li>• Distance-settable</li> </ul>	<ul style="list-style-type: none"> <li>• Retro-reflective</li> <li>• Distance-settable</li> </ul>	<ul style="list-style-type: none"> <li>• Through-beam</li> <li>• Retro-reflective</li> <li>• Diffuse</li> </ul>
Maximum sensing distances	<ul style="list-style-type: none"> <li>• Retro-reflective: 2 m</li> </ul>	<ul style="list-style-type: none"> <li>• 500 mm</li> </ul>	<ul style="list-style-type: none"> <li>• Retro-reflective: 10 m</li> <li>• Distance-settable: 2 m</li> </ul>	<ul style="list-style-type: none"> <li>• Through-beam: 10 m</li> <li>• Retro-reflective: 4 m</li> <li>• Diffuse: 700 mm</li> </ul>
Supply voltage	10-30 VDC	10-30 VDC	12-240 VDC 24-240 VAC	12-240 VDC 24-240 VAC
Output type	Light-on/Dark-on	Light-on/Dark-on	Light-on/Dark-on	Light-on/Dark-on
Output state	NPN or PNP	NPN or PNP	NPN or PNP; Relay output	Relay or SSR
Connections	Pre-wired, Connector	Pre-wired	Pre-wired	Pre-wired, Terminal block
IP rating	IP67	IP67	IP67 (with protective cover)	IP64

# Selection Table

					
Model	E3T	E3S-A	E3K	F3UV	E3Z-K
Product type	Miniature	Built-in amplifier	Long distance	Ultraviolet intensity detection	Oil resistant
Sensor type	<ul style="list-style-type: none"> <li>• Through-beam</li> <li>• Retro-reflective</li> <li>• Diffuse</li> <li>• Convergent reflective</li> <li>• Background suppression</li> </ul>	<ul style="list-style-type: none"> <li>• Through-beam</li> <li>• Retro-reflective</li> <li>• Diffuse</li> </ul>	<ul style="list-style-type: none"> <li>• Retro-reflective</li> <li>• Diffuse</li> </ul>	<ul style="list-style-type: none"> <li>• UV intensity</li> </ul>	<ul style="list-style-type: none"> <li>• Through-beam</li> <li>• Retro-reflective</li> <li>• Diffuse</li> </ul>
Maximum sensing distances	<ul style="list-style-type: none"> <li>• Through-beam: 2 m</li> <li>• Retro-reflective: 200 mm</li> <li>• Diffuse: 30 mm</li> <li>• Convergent reflective: 30 mm</li> <li>• Background suppression: 30 mm</li> </ul>	<ul style="list-style-type: none"> <li>• Through-beam: 7 m</li> <li>• Retro-reflective: 2 m</li> <li>• Diffuse: 700 mm</li> </ul>	<ul style="list-style-type: none"> <li>• Retro-reflective: 10 m</li> <li>• Diffuse: 2 m</li> </ul>	• N/A	<ul style="list-style-type: none"> <li>• Through-beam: 15 m</li> <li>• Retro-reflective: 4 m</li> <li>• Diffuse: 1 m</li> </ul>
Supply voltage	12-24 VDC	10-30 VDC	24-240 VDC 42-240 VAC	12-24 VDC	12-24 VDC
Output type	Light-on/Dark-on	Light-on/Dark-on	Light-on/Dark-on	Analog	Light-on/Dark-on
Output state	NPN or PNP	NPN or PNP	Relay	NPN or PNP	NPN or PNP
Connections	Pre-wired	Pre-wired, Connector	Plated steel screw terminals	Pre-wired	Pre-wired, Connector
IP rating	IP65, IP67	IP67	IP67	IP30	IP67

					
Model	E3S-C	F3ET2	F3EM2	E3NC	E3C-LDA
Product type	Long distance metal body detector	Discrete output light grid	Analog output light grid	Laser sensor with separate amplifier	Laser sensor with separate amplifier
Sensor type	<ul style="list-style-type: none"> <li>• Through-beam</li> <li>• Retro-reflective</li> <li>• Diffuse</li> </ul>	<ul style="list-style-type: none"> <li>• Through-beam</li> </ul>	<ul style="list-style-type: none"> <li>• Through-beam</li> </ul>	<ul style="list-style-type: none"> <li>• Diffuse</li> <li>• Limited-reflective</li> <li>• Retro-reflective</li> <li>• Distance-settable CMOS</li> </ul>	<ul style="list-style-type: none"> <li>• Diffuse</li> <li>• Retro-reflective</li> </ul>
Maximum sensing distances	<ul style="list-style-type: none"> <li>• Through-beam: 30 m</li> <li>• Retro-reflective: 3 m</li> <li>• Diffuse: 2 m</li> </ul>	<ul style="list-style-type: none"> <li>• Through-beam: 3 m or 15 m</li> </ul>	<ul style="list-style-type: none"> <li>• Through-beam: 3 m or 15 m</li> </ul>	<ul style="list-style-type: none"> <li>• E3NC-L Diffuse: 1.2 m</li> <li>• E3NC-L Limited-reflective: 70 mm</li> <li>• E3NC-L Retro-reflective: 8 m</li> <li>• E3NC-S Distance-settable: 250 mm</li> </ul>	<ul style="list-style-type: none"> <li>• Diffuse: 1 m</li> <li>• Retro-reflective: 7 m</li> </ul>
Supply voltage	10-30 VDC	24 VDC	24 VDC	10-30 VDC	12-24 VDC
Output type	Light-on/Dark-on	Light-on/Dark-on Selectable	Light-on/Dark-on Selectable	Light-on/Dark-on Selectable	Light-on/Dark-on Selectable
Output state	NPN or PNP	NPN or PNP Selectable	0-10 VDC	NPN or PNP	NPN or PNP, 1-5 VDC
Connections	Pre-wired, Connector	M12 5-pin	M12 5-pin	Pre-wired, connector	Pre-wired, connector
IP rating	IP67	IP65	IP65	IP65	IP40 head; IP50 amp





## All-Application Sensors in Plastic M18 Housing

The E3FA/E3RA family provides a wide range of high quality sensors, with models designed for standard or special applications.

- Compact size with flush mounting option
- IP67, IP69K for wash down resistance
- Straight or Radial models in cylindrical M18 plastic housing
- Background suppression, Limited Distance and Transparent detection models

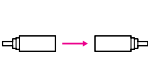

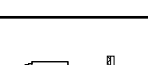
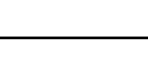
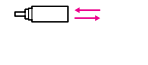
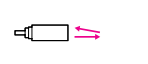
## Sensor Type

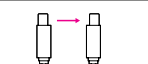
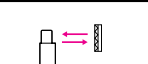
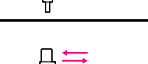
Setup	Sensor type		Sensing distance	PNP		NPN	
				Pre-wired (2 m)	M12 connector	Pre-wired (2 m)	M12 connector
Straight		Through-beam *1	20 m	E3FA-TP11 2M	E3FA-TP21	E3FA-TN11 2M	E3FA-TN21
		Retro-reflective *2	0.1 to 4 m*	E3FA-RP11 2M	E3FA-RP21	E3FA-RN11 2M	E3FA-RN21
		Retro-reflective (coaxial) *2	0 to 500 mm*	E3FA-RP12 2M	E3FA-RP22	E3FA-RN12 2M	E3FA-RN22
		Diffuse-reflective	100 mm	E3FA-DP11 2M	E3FA-DP21	E3FA-DN11 2M	E3FA-DN21
			300 mm	E3FA-DP12 2M	E3FA-DP22	E3FA-DN12 2M	E3FA-DN22
			1 m	E3FA-DP13 2M	E3FA-DP23	E3FA-DN13 2M	E3FA-DN23
		BGS (Background suppression)	100 mm	E3FA-LP11 2M	E3FA-LP21	E3FA-LN11 2M	E3FA-LN21
			200 mm	E3FA-LP12 2M	E3FA-LP22	E3FA-LN12 2M	E3FA-LN22
	Limited distance reflective	10 to 50 mm	E3FA-VP11 2M	E3FA-VP21	E3FA-VN11 2M	E3FA-VN21	
	Transparent detection *2	100 to 500 mm**	E3FA-BP11 2M	E3FA-BP21	E3FA-BN11 2M	E3FA-BN21	
		0.1 to 2 m**	E3FA-BP12 2M	E3FA-BP22	E3FA-BN12 2M	E3FA-BN22	
Radial		Through-beam *1	15 m	E3RA-TP11 2M	E3RA-TP21	E3RA-TN11 2M	E3RA-TN21
		Retro-reflective *2	0.1 to 3 m*	E3RA-RP11 2M	E3RA-RP21	E3RA-RN11 2M	E3RA-RN21
		Diffuse-reflective	100 mm	E3RA-DP11 2M	E3RA-DP21	E3RA-DN11 2M	E3RA-DN21
			300 mm	E3RA-DP12 2M	E3RA-DP22	E3RA-DN12 2M	E3RA-DN22
			700 mm	E3RA-DP13 2M	E3RA-DP23	E3RA-DN13 2M	E3RA-DN23

\*Measured with reflector E39-R1S. \*\*Measured with reflector E39-RP1

\*1 The set type includes the emitter and receiver. \*2 The reflector is sold separately.

Note: All sensors are 10-30 VDC. Light-On/Dark-On selectable by wiring.







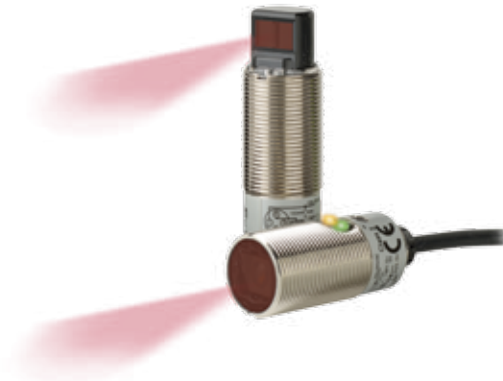

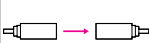

## All-Application Sensors in Brass M18 Housing

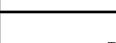
The E3FB/E3RB family provides a wide range of high quality sensors, with models designed for standard or special applications.

- Compact size with flush mounting option
- IP67, IP69K for wash down resistance
- Straight or Radial models in cylindrical M18 brass housing
- Background suppression, Limited Distance and Transparent detection models



### Sensor Type

Setup	Sensor type		Sensing distance	PNP		NPN	
				Pre-wired (2 m)	M12 connector	Pre-wired (2 m)	M12 connector
Straight		Through-beam *1	20 m	E3FB-TP11 2M	E3FB-TP21	E3FB-TN11 2M	E3FB-TN21
		Retro-reflective *2	0.1 to 4 m*	E3FB-RP11 2M	E3FB-RP21	E3FB-RN11 2M	E3FB-RN21
		Retro-reflective (coaxial) *2	0 to 500 mm*	E3FB-RP12 2M	E3FB-RP22	E3FB-RN12 2M	E3FB-RN22
		Diffuse-reflective	100 mm	E3FB-DP11 2M	E3FB-DP21	E3FB-DN11 2M	E3FB-DN21
			300 mm	E3FB-DP12 2M	E3FB-DP22	E3FB-DN12 2M	E3FB-DN22
			1 m	E3FB-DP13 2M	E3FB-DP23	E3FB-DN13 2M	E3FB-DN23
		BGS (Background suppression)	100 mm	E3FB-LP11 2M	E3FB-LP21	E3FB-LN11 2M	E3FB-LN21
			200 mm	E3FB-LP12 2M	E3FB-LP22	E3FB-LN12 2M	E3FB-LN22
	Limited distance reflective	10 to 50 mm	E3FB-VP11 2M	E3FB-VP21	E3FB-VN11 2M	E3FB-VN21	
	Transparent detection *2	100 to 500 mm**	E3FB-BP11 2M	E3FB-BP21	E3FB-BN11 2M	E3FB-BN21	
		0.1 to 2 m**	E3FB-BP12 2M	E3FB-BP22	E3FB-BN12 2M	E3FB-BN22	
Radial		Through-beam *1	15 m	E3RB-TP11 2M	E3RB-TP21	E3RB-TN11 2M	E3RB-TN21
		Retro-reflective *2	0.1 to 3 m*	E3RB-RP11 2M	E3RB-RP21	E3RB-RN11 2M	E3RB-RN21
		Diffuse-reflective	100 mm	E3RB-DP11 2M	E3RB-DP21	E3RB-DN11 2M	E3RB-DN21
			300 mm	E3RB-DP12 2M	E3RB-DP22	E3RB-DN12 2M	E3RB-DN22
			700 mm	E3RB-DP13 2M	E3RB-DP23	E3RB-DN13 2M	E3RB-DN23

\*Measured with reflector E39-R1S. \*\*Measured with reflector E39-RP1

\*1 The set type includes the emitter and receiver. \*2 The reflector is sold separately.

Note: All sensors are 10-30 VDC. Light-On/Dark-On selectable by wiring.



## M18 Stainless Steel for Superior Environmental Resistance

The E3FC family provides a wide range of high quality sensors, with models designed for standard or special applications.

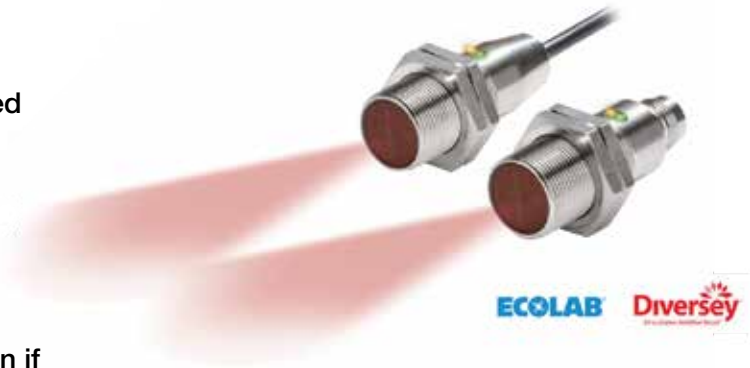
- High grade stainless steel housing (SUS316L)
- IP67, IP68, IP69K for high temperature wash down resistance
- Epoxy resin prevents water ingress even if connector is not properly attached
- Proven with various industrial detergents of Ecolab and Diversey

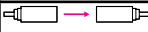
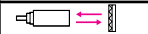

## Sensor Type

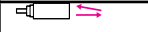
Setup	Sensor type	Sensing distance	PNP		NPN	
			Pre-wired (2 m)	M12 connector	Pre-wired (2 m)	M12 connector
Straight	 Through-beam *1	20 m	E3FC-TP11 2M	E3FC-TP21	E3FC-TN11 2M	E3FC-TN21
	 Retro-reflective (using reflector E39-R1S sold separately.)	0.1 to 4 m	E3FC-RP11 2M	E3FC-RP21	E3FC-RN11 2M	E3FC-RN21
	 Diffuse-reflective	300 mm	E3FC-DP12 2M	E3FC-DP22	E3FC-DN12 2M	E3FC-DN22
		1 m	E3FC-DP13 2M	E3FC-DP23	E3FC-DN13 2M	E3FC-DN23
	 BGS (Background suppression)	100 mm	E3FC-LP11 2M	E3FC-LP21	E3FC-LN11 2M	E3FC-LN21
		200 mm	E3FC-LP12 2M	E3FC-LP22	E3FC-LN12 2M	E3FC-LN22

\*1 The set type includes the emitter and receiver.

Note: All sensors are 10-30 VDC. Light-On/Dark-On selectable by wiring.





Note: Please reference data sheet for infrared options for diffuse-reflective type E3FC sensors.

## General Purpose Sensor in Compact Plastic Housing

Compact housing size and high-power LED for excellent performance-size ratio and best value-performance ratio for standard applications.

- Minimal optical axis deviation for easy alignment
- IP67 and IP69K for highest water resistance
- Intensive shielding for highest noise immunity (EMC)
- Multiple molding housing for high mechanical resistance

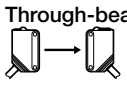
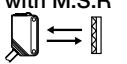
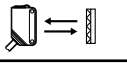
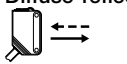
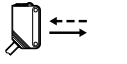
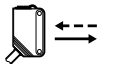
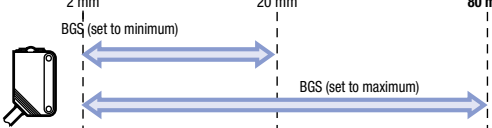

Sensor type		Sensing distance	Connection Method		Model	
			 M8		NPN output	PNP output
 Through-beam 30 m (Infrared light)			—	2 m	E3Z-T62	E3Z-T82
			■	—	E3Z-T67	E3Z-T87
			—	2 m	E3Z-T61A	E3Z-T81A
			■	—	E3Z-T66A	E3Z-T86A
 Retro-reflective with M.S.R. 0.1 to 4 m (with E39-R1S) (Red light)			—	2 m	E3Z-R61	E3Z-R81
			■	—	E3Z-R66	E3Z-R86
 Retro-reflective without M.S.R. 0.1 to 5 m (with E39-R1S) (Infrared light)			—	2 m	E3Z-R61-4	E3Z-R81-4
			■	—	E3Z-R66-4	E3Z-R86-4
 Diffuse-reflective 1 m (adjustable) (Infrared light)			—	2 m	E3Z-D62	E3Z-D82
			■	—	E3Z-D67	E3Z-D87
 Diffuse-reflective wide beam 100 mm (adjustable) (Infrared light)			—	2 m	E3Z-D61	E3Z-D81
			■	—	E3Z-D66	E3Z-D86
 Distance-settable (background suppression) <sup>2</sup>	Small spot (Red light)		—	2 m	E3Z-LS63	E3Z-LS83
			■	—	E3Z-LS68	E3Z-LS88
	Standard (Red light) (note 1)		—	2 m	E3Z-LS61 <sup>2</sup>	E3Z-LS81 <sup>2</sup>
			■	—	E3Z-LS66 <sup>2</sup>	E3Z-LS86 <sup>2</sup>

<sup>1</sup> Infrared light models available

<sup>2</sup> To order with 30 cm long pigtail with M12, M8 3-pin or 4-pin connector please contact your OMRON representative.



\*Coming in Fall 2015

## Rectangular Body with M18 Barrel Nose for Flexible Mounting

The new E3Z-F shaped series is added to the wide Omron E3Z offering.

- Visible red LED for easier alignment and trouble-shooting
- E3Z-F is available in Through-beam, Diffuse, and polarized Retro-Reflective
- Diffuse-reflective: 100 mm, 300 mm, 500 mm, 1 m
- Through-beam: 20 m, Retro-reflective: 4 m



**NEW**

## Features

Visible spot with all models for easy installation



Many different sensing distances are available, so you can select the best model for your application distance

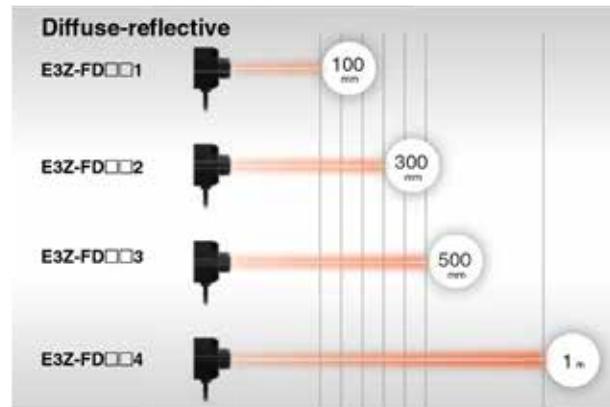

## Application

Materials Handling: Detect passing cardboard boxes

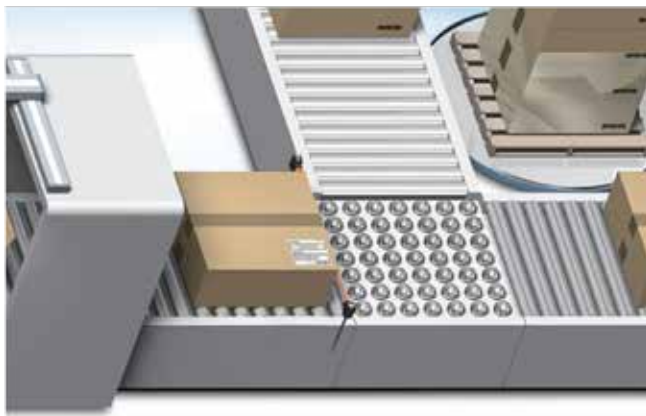

Molding Machines: Detect falling molded objects

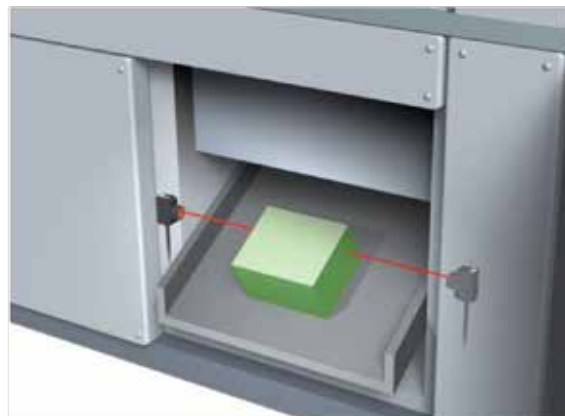





## LASER Sensor in Compact Plastic Housing

The E3Z LASER sensor in compact plastic housing features visible Laser light for precision positioning and detection applications.

- Visible LASER light for precision positioning and small object detection
- High power laser diode for long range precision
- Class 1 LASER (JIS, IEC) Class 2 (FDA) LASER
- Precise background suppression and low black/white error for accurate detection

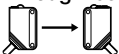

Sensor type	Sensing distance	Response time	Connection Method		Model	
			 M8		NPN output	PNP output
Through-beam 	60 m	1 ms	—	2 m	E3Z-LT61 2M	E3Z-LT81 2M
			■	—	E3Z-LT66	E3Z-LT86
Retro-reflective with M.S.R 	0.3 to 15 m (with E39-R15)		—	2 m	E3Z-LR61 2M	E3Z-LR81 2M
			■	—	E3Z-LR66	E3Z-LR86
Distance-settable (background suppression) 	20 to 300 mm		—	2 m	E3Z-LL61 2M	E3Z-LL81 2M
			■	—	E3Z-LL66	E3Z-LL86
	25 to 300 mm	0.5 ms	—	2 m	E3Z-LL63 2M	E3Z-LL83 2M
			■	—	E3Z-LL68	E3Z-LL88

Note: To order with 30 cm long pigtail with M12, M8 3-pin or M8 4-pin connector please contact your OMRON representative.

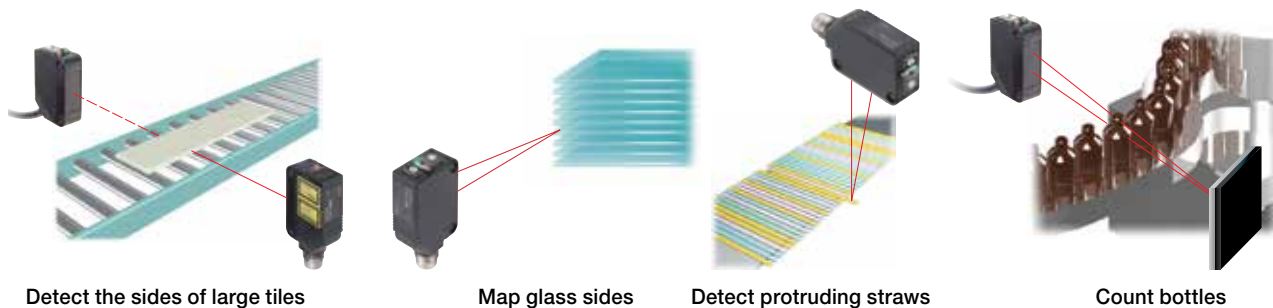

Detect the sides of large tiles

Map glass sides

Detect protruding straws

Count bottles

## Detergent-Resistant Photoelectric Sensor in Compact Stainless Steel Housing

Compact housing size and high power LED for excellent performance-size ratio in a rugged, detergent-resistant stainless steel housing for demanding environments.

- High grade stainless steel housing (SUS316L)
- IP67 and IP69K for highest water resistance
- ECOLAB tested and certified detergent resistance



Sensor type	Sensing distance	Connection Method			Model	
		M8	2 m	30 cm	NPN output	PNP output
Through-beam 	15 m	—	2 m	*1 For ordering digital versions replace "2M" of the cable types with: - S1J: for M12 stainless steel plug with 30 cm cable - S3J: for M8 4-pin stainless steel plug with 30 cm cable - S5J: for M8 3-pin stainless steel plug with 30 cm cable (except for background suppression types) - M1J: for M12 brass plug with 30 cm cable - M3J: for M8 4-pin brass plug with 30 cm cable - M5J: for M8 3-pin brass plug with 30 cm cable (except for background suppression types)	E3ZM-T61 2M	E3ZM-T81 2M
	0.8 m with built in slit	—	2 m		E3ZM-T66	E3ZM-T86
		—	2 m		E3ZM-T63 2M	E3ZM-T83 2M
	Retro-reflective with M.S.R 	0.1 to 4 m (with E39-R1S)	—		2 m	E3ZM-T68
—			2 m		E3ZM-R61 2M	E3ZM-R81 2M
Diffuse-reflective 	1 m (adjustable)	—	2 m		E3ZM-R66	E3ZM-R86
		—	2 m		E3ZM-D62 2M	E3ZM-D82 2M
Diffuse-reflective (background suppression) 	10 to 100 mm (fixed)	—	2 m		E3ZM-D67	E3ZM-D87
	10 to 200 mm (fixed)	—	2 m		E3ZM-LS61X 2M <sup>2</sup>	E3ZM-LS81X 2M <sup>2</sup>
		—	2 m		E3ZM-LS66X <sup>2</sup>	E3ZM-LS86X <sup>2</sup>
	—	2 m	E3ZM-LS64X 2M <sup>2</sup>		E3ZM-LS84X 2M <sup>2</sup>	
—	2 m	E3ZM-LS69X <sup>2</sup>	E3ZM-LS89X <sup>2</sup>			

<sup>2</sup> E3ZM-LS\_X are fixed LIGHT-ON models. For Fixed DARK-ON models order E3ZM-LS\_Y and for L-NO/D-NO selectable by wire please order E3ZM-LS\_H.



Robust construction



Tight housing

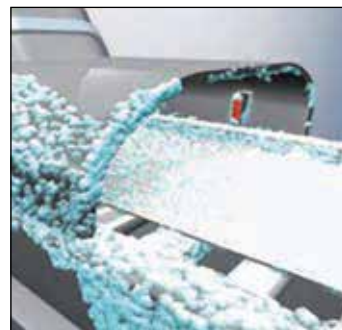







Detergent resistant

## Oil-Resistant Photoelectric Sensor in Compact Stainless Steel Housing

The oil-resistant compact photoelectric sensor in a robust stainless steel housing features reliable object detection in dirty and mechanically demanding environments such as automotive assembly lines.

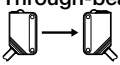
- Oil-resistant stainless steel housing
- IP67 and IP69K for highest water resistance
- High visibility orange LED in through-beam model for easy alignment



Sensor type	Sensing distance	Connection Method			Model	
		 M8		 M12	NPN output	PNP output
Through-beam 	15 m (infrared light)	—	2 m	—	E3ZM-CT61 2M	E3ZM-CT81 2M
		—	—	■	E3ZM-CT61-M1TJ	E3ZM-CT81-M1TJ
		■	—	—	E3ZM-CT66	E3ZM-CT86
	20 m (Orange light)	—	2 m	—	E3ZM-CT62B 2M	E3ZM-CT82B 2M
		—	—	■	E3ZM-CT62B-M1TJ	E3ZM-CT82B-M1TJ
		■	—	—	E3ZM-CT67B	E3ZM-CT87B
Retro-reflective with M.S.R 	0.1 to 4 m (with E39-R1S)	—	2 m	—	E3ZM-CR61 2M	E3ZM-CR81 2M
		—	—	■	E3ZM-CR61-M1TJ	E3ZM-CR81-M1TJ
		■	—	—	E3ZM-CR66	E3ZM-CR86
Diffuse-reflective 	1 m (adjustable)	—	2 m	—	E3ZM-CD62 2M	E3ZM-CD82 2M
		—	—	■	E3ZM-CD62-M1TJ	E3ZM-CD82-M1TJ
		■	—	—	E3ZM-CD67	E3ZM-CD87
Diffuse-reflective (background suppression) 	10 to 100 mm (fixed)	—	2 m	—	E3ZM-CL61H 2M	E3ZM-CL81H 2M
		—	—	■	E3ZM-CL61H-M1TJ	E3ZM-CL81H-M1TJ
		■	—	—	E3ZM-CL66H	E3ZM-CL86H
	10 to 200 mm (fixed)	—	2 m	—	E3ZM-CL64H 2M	E3ZM-CL84H 2M
		—	—	■	E3ZM-CL64H-M1TJ	E3ZM-CL84H-M1TJ
		■	—	—	E3ZM-CL69H	E3ZM-CL89H

Note: M12 connector types use Omron Automation and Safety's XS5 Series "Twist & Click" M12 connector cordsets, 30 cm standard length.





## Print Mark Detection Photoelectric Sensor in Compact Stainless Steel Housing

The detergent resistant photoelectric sensor in a robust stainless steel housing provides reliable detection of all common print marks in food packaging applications.

- White LED for stable detection of differently colored or black print marks
- SUS 316L stainless steel housing
- Easy-to-use teach-in button or remote teach
- Fast response time of 50  $\mu$ s

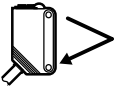

J

Sensor type	Sensing distance	Connection Method		Model	
		 M8		NPN output	PNP output
 Mark sensor	12 $\pm$ 2 mm	—	2 m	E3ZM-V61 2M	E3ZM-V81 2M
			—	E3ZM-V66	E3ZM-V86

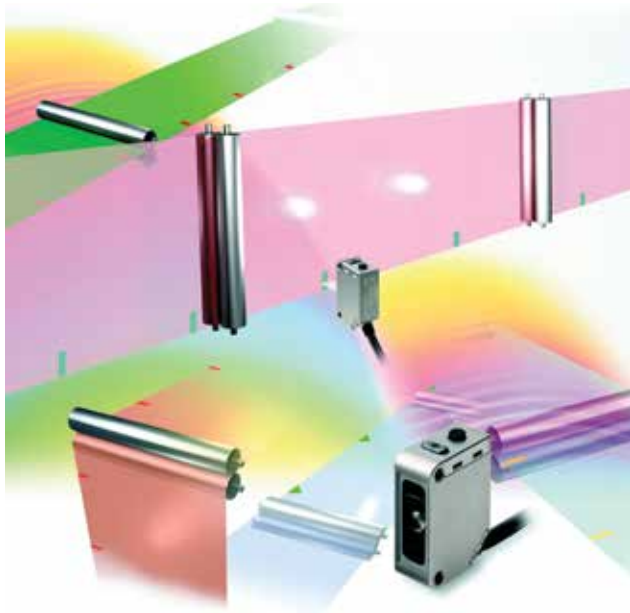

## Transparent Object Detection Sensor in Compact Stainless Steel Housing

The E3ZM-B family provides models for general transparent material detection and specialized models providing highest stability for the detection of PET bottles.

- Detergent resistant compact SUS316L housing
- Includes Bi-refrangent, P-opaquiring sensing technology to provide the margin necessary to overcome the challenges in geometry, color and contents of PET bottle detection which standard retro-reflective sensors can not perform
- Simple push button teach operation
- Unique AC3 technology compensates for lens contamination to maintain expected sensor output
- IP69K (DIN 40050-9) compliant
- 316L stainless steel body resists detergents and disinfectants
- High noise immunity against interference from inverters and other inductive loads



Sensor type		Sensing distance	Special reflector	Connection Method		Model	
				M8		NPN output	PNP output
Retro-reflective with M.S.R. 	Optimized for PET bottles and trays	100 to 500 mm (teachable)	Order separately <sup>1</sup>	—	2 m	E3ZM-B61 2M	E3ZM-B81 2M
			E39-RP1 included	■	—	E3ZM-B66	E3ZM-B86
				—	2 m	E3ZM-B61-C 2M	E3ZM-B81-C 2M
			■	—	E3ZM-B66-C	E3ZM-B86-C	
Retro-reflective with M.S.R. 	For all transparent media (glass, PET, foils)	100 to 500 mm (potentiometer adjustment) <sup>3</sup>	Order separately <sup>3</sup>	—	2 m	E3ZM-B61T 2M	E3ZM-B81T 2M
			■	—	E3ZM-B66T	E3ZM-B86T	

<sup>1</sup> For higher signal stability using circular polarization functionality for PET bottles, order special reflector E39-RP1 separately.

<sup>2</sup> Teachable all-transparent-media types are available. Contact your Omron Automation and Safety representative.

<sup>3</sup> Order reflector separately: Use E39-RP1 for 500 mm sensing distance; E39-RP37 or E39-RSP1 for 250 mm sensing distance.

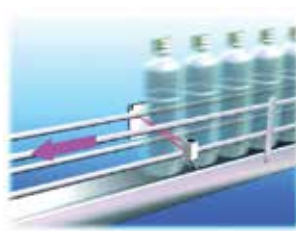

# E3Z-B Photoelectric Sensors

Quick Link

B271

omron247.com

## Transparent Bottle Detection Photoelectric Sensor in Compact Plastic Housing

The E3Z-B provides easy adjustment for the detection of a large variety of standard transparent objects.

- Detects a wide range of bottles from single bottles to sets of stocked bottles
- IP67/IP69K tested for highest water resistance



Sensor type	Sensing distance (with E39-R1S reflector)	Connection Method		Model	
		M8		NPN output	PNP output
Retro-reflective without M.S.R. 	80 to 500 mm (adjustable)	—	2 m	E3Z-B61 2M	E3Z-B81 2M
		■	—	E3Z-B66	E3Z-B86
	0.5 to 2 m (adjustable)	—	2 m	E3Z-B62 2M	E3Z-B82 2M
		■	—	E3Z-B67	E3Z-B87

J

# E3Z-G Photoelectric Sensors

Quick Link

B268

omron247.com

## Photoelectric Sensor in Plastic Fork Shape Housing

The forked shape optical through-beam sensors combine simple installation with reliable passage detection of objects, machine parts or transportation elements such as hanging carriers.

- Slotted head eliminates the need for optical axis adjustment
- 1 or 2 axis models



Sensor type	Sensing distance	Number of optical axes	Connection Method		Model	
					NPN output	PNP output
Through-beam 	25 mm (Infrared light)	1	2 m	—	E3Z-G61	E3Z-G81
			—	■ M8 4-pin	E3Z-G61-M3J	E3Z-G81-M3J
		2	2 m	—	E3Z-G62	E3Z-G82
			—	■ M8 4-pin	E3Z-G62-M3J	E3Z-G82-M3J

## Narrow-Beam Sensor Detects Small Objects

- Small 2.5 mm beam diameter at 90 mm sensing distance enables detection through small holes or gaps
- Detect objects as small as 0.1 mm diameter
- Adjustable distance setting of  $90 \pm 30$  mm
- Visible red light beam simplifies alignment for visual checking of sensing spot position
- Integrated circuit design with advanced LED assures long sensing distances
- High noise immunity against interference from inverters and other inductive loads
- Rated IP67, withstands 1200 psi washdown
- Switch-selectable, Light-ON/Dark-ON operation



## Narrow-Beam Sensors

Sensor type	Setup	Features	Light source	Sensing distance	Connection method	Model	
						NPN output	PNP output
Diffuse reflective		Detects 0.1 mm dia. objects	Red (650 nm)	90 ±30 mm	Pre-wired	E3Z-L61	E3Z-L81
					4-pin M8 Connector	E3Z-L66	E3Z-L86



### Miniature Distance-Settable Sensors with Built-In Amplifiers

- Detect glossy/uneven surfaces with foreground suppression
- Ignore objects beyond the set distance such as a conveyor belt or rail using background suppression
- Web/edge position detection sensors (E3Z-LS63/-LS83) with 2 mm spot eliminate background influences in printing, converting and packaging
- Detect presence of strip and sheet materials and non-woven fabric edges with 2% max. differential travel to compensate for vibration (E3Z-LS63/-LS83)
- Integrated circuit design with advanced LED assures long sensing distances
- High noise immunity against interference from inverters and other inductive loads
- Rated IP67, withstands 1200 psi washdown
- Switch-selectable, Light-ON/Dark-ON operation



J

### Background/Foreground Suppression Sensors

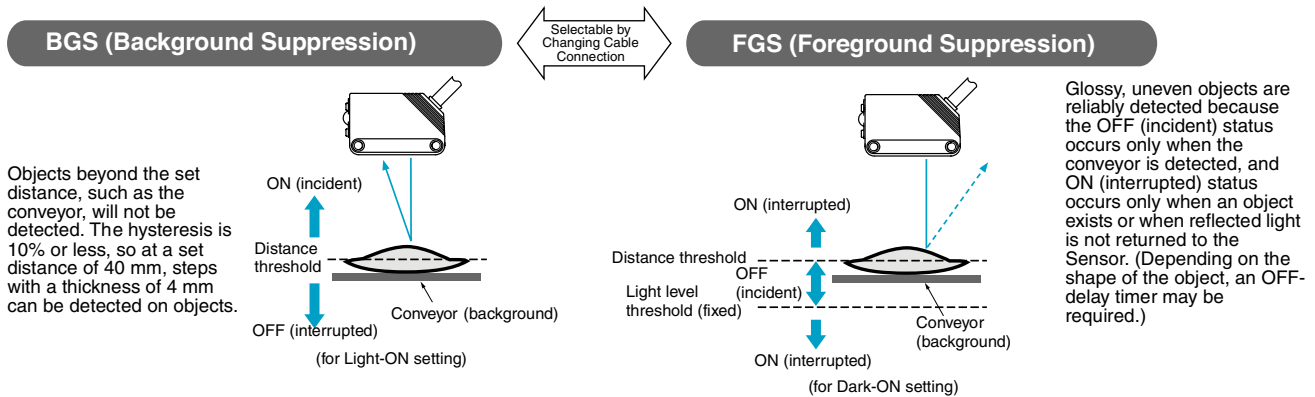

Sensor type	Setup	Features	Light source	Sensing distance	Connection method	Model	
						NPN output	PNP output
Distance settable		Resists interference from fluorescent lighting	Red (680 nm)	Background setting	Pre-wired	E3Z-LS61	E3Z-LS81
				20 to 200 mm	4-pin M8 Connector	E3Z-LS66	E3Z-LS86
		Web/edge position detector	Red (650 nm)	Background setting	Pre-wired	E3Z-LS63	E3Z-LS83
				2 to 80 mm	4-pin M8 Connector	E3Z-LS68	E3Z-LS88

## Oil-Resistant Sensors with Built-In Amplifiers

- Sensor housing includes special coating to resist effects in environments subject to high pH oil mists, coolants and medium pH detergents that aggressively attach sensors
- Long distance sensing: 15 m through-beam models; 3 m retro-reflective; 1 m diffuse-reflective
- High noise immunity against interference from inverters and other inductive loads
- Rated IP67, withstands 1200 psi washdown
- Switch-selectable, Light-ON/Dark-ON operation



## Sensor Type

Sensor type	Setup	Features	Light source	Sensing distance	Connection method	Model	
						NPN output	PNP output
Through-beam		—	Infrared (870 nm)	15 m	Pre-wired	E3Z-T61K	E3Z-T81K
					Pigtail, 4-pin M8	E3Z-T61K-M3J 0.3M	E3Z-T81K-M3J 0.3M
Retro-reflective		Polarized; Order reflector separately	Red (660 nm)	0.1 to 4 m with E39-R1S reflector 0.1 to 3 m with E39-R1 reflector	Pre-wired	E3Z-R61K	E3Z-R81K
					Pigtail, 4-pin M8	E3Z-R61K-M3J 0.3M	E3Z-R81K-M3J 0.3M
Diffuse reflective		Wide view	Infrared (860 nm)	5 to 100 mm	Pre-wired	E3Z-D61K	E3Z-D81K
					Pigtail, 4-pin M8	E3Z-D61K-M3J 0.3M	E3Z-D81K-M3J 0.3M
		Standard		1 m	Pre-wired	E3Z-D62K	E3Z-D82K
					Pigtail, 4-pin M8	E3Z-D62K-M3J 0.3M	E3Z-D82K-M3J 0.3M

## Distance-Settable Sensor in Metal Housing

- Minimal black/white error for highest reliability detecting differently colored objects
- Setting distance up to 500 mm with reliable background suppression
- Stable detection regardless of the target workpiece color, material or size
- Simple to set distance with 6-turn adjustor and indicator



Sensor type	Light source	Sensing distance	Connection method		Model
Distance-settable (background suppression) 	Red (700 mm)		2 m	—	E3S-CL1
			—		E3S-CL1-M1J
	Infrared (860 mm)		2 m	—	E3S-CL2
			—		E3S-CL2-M1J

# E3G Photoelectric Sensors

## Long Distance Sensor in Plastic Housing

Long distance retro-reflective and teachable distance-settable sensors in plastic housing.

- Distance-settable model with 1.2 m maximum setting distance
- Light-On/Dark-On operation, NPN/PNP output switch selectable





Sensor type	Sensing distance	Connection method		Model
Retro-reflective with M.S.R. 	0.5 to 10 m measured with E39-R2	—	2 m	E3G-R13-G 2M
			—	E3G-R17-G
Distance-settable (background suppression) 	0.2 to 2 m (0.2 to 1.2 m distance-settable)	—	2 m	E3G-L73 2M
			—	E3G-L77

## All Voltage (AC/DC) Photoelectric Sensor in Plastic Housing

The square sized E3JM family uses 12 to 240 VDC and 24 to 240 VAC supply voltage, an enhanced sensing distance and a timer function.

- Easy to wire terminal block speeds installation and servicing
- Relay or solid state relay output
- Timer function models available
- Mounting hardware and terminal protection cover included

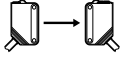
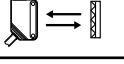

Sensor type	Sensing distance	Connection method	Operation mode	Model		
				Relay output	DC SSR output	
					NPN Output	PNP Output
Through-beam 	10 m (Infrared light)	Terminal block (with PG 13.5 conduit opening)	—	E3JM-10M4-US	E3JM-10S4-US OMS	E3JM-10R4-US
			ON or OFF delay 0.1 s to 5 s (adjustable)	E3JM-10M4T-US	E3JM-10S4T-US	E3JM-10R4T-US
Retro-reflective with M.S.R. 	4 m with E39-R1 reflector (Red light)		—	E3JM-R4M4-US	E3JM-R4S4-US	E3JM-R4R4-US
			ON or OFF delay 0.1 s to 5 s (adjustable)	E3JM-R4M4T-US	E3JM-R4S4T-US	E3JM-R4R4T-US
Diffuse-reflective 	700 mm (adjustable) (Infrared light)		—	E3JM-DS70M4-US	E3JM-DS70S4-US	E3JM-DS70R4-US
			ON or OFF delay 0.1 s to 5 s (adjustable)	E3JM-DS70M4T-US	E3JM-DS70S4T-US	E3JM-DS70R4T-US

# E3G-M Photoelectric Sensors

## Long Distance All Voltage (AC/DC) Photoelectric Sensor

The E3G-M series offers the long sensing distance of the E3G family for all voltage (AC/DC) installations.

- 12 to 240 VDC and 24 to 240 VAC
- Terminal block connection

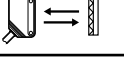
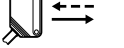

Sensor type	Sensing distance	Connection method	Timer Function	Model
				Relay output
Retro-reflective with M.S.R. 	0.5 to 10 m with E39-R2 reflector (Red light)	Terminal block	—	E3G-MR19-G
			ON or OFF delay 0 to 5 s (adjustable)	E3G-MR19T-G
Distance-settable (background detection) 	0.2 to 2 m (0.2 to 1.2 m distance-settable) (Infrared light)		—	E3G-ML79-G
			ON or OFF delay 0 to 5 s (adjustable)	E3G-ML79T-G

## Photoelectric Sensor in Miniature Plastic Housing

Small sized photoelectric sensors in flat, side view and M5 cylindrical shapes for demanding mounting conditions.

- Small size with precision pinpoint LED
- 3.5 mm flat model with reliable background suppression and small black/white error
- Unique optical alignment technology ensuring minimal deviation of optical axis
- High EMC and ambient light immunity



Sensor type	Sensing distance	Connection Method		Operation mode	Model (note 1)		
					NPN output	PNP output	
Through-beam 	1 m	2 m	To order pigtail connector versions, replace "2M" for cable types if present, then add a suffix: - M1TJ 0.3M: M12 with 30 cm cable - M3J 0.3M: M8 4-pin with 30 cm cable	Light- ON	E3T-ST11	E3T-ST13	
	300 mm			Dark-ON	E3T-ST12	E3T-ST14	
	Through-beam 			500 mm	Light- ON	E3T-ST21	E3T-ST23
				300 mm	Dark-ON	E3T-ST22	E3T-ST24
Through-beam, M5 				1 m	Light- ON	E3T-FT11	E3T-FT13
				Through-beam, M5 	500 m	Dark-ON	E3T-FT12
Retro-reflective (note 3)	30 to 200 mm on reflectors/ 10 to 100 mm on reflective foils (note 2)				Light- ON	E3T-CT21	E3T-CT23
	Diffuse-reflective 			5 to 30 mm	Dark-ON	E3T-CT22	E3T-CT24
Diffuse-reflective (with adjuster), M6 				3-50 mm	Dark-ON	E3T-CT22S	E3T-CT24S
	Limited-reflective 			5 to 15 mm	Light- ON	E3T-SR41-C	E3T-SR43-C
Diffuse-reflective (background suppression) 				1 to 15 mm	Dark-ON	E3T-SR42-C	E3T-SR44-C
				Limited-reflective 	5 to 30 mm	Light- ON	E3T-FD11
Diffuse-reflective (background suppression) 					1 to 15 mm	Dark-ON	E3T-FD12
	Limited-reflective 			5 to 15 mm	Dark-ON	E3T-CD11	E3T-CD13
5 to 30 mm					Light- ON	E3T-SL11	E3T-SL13
				1 to 15 mm	Dark-ON	E3T-SL12	E3T-SL14
1 to 30 mm		Light- ON	E3T-SL21		E3T-SL23		
	1 to 15 mm	Dark-ON	E3T-SL22	E3T-SL24			
1 to 30 mm		Light- ON	E3T-FL11	E3T-FL13			
	1 to 15 mm	Dark-ON	E3T-FL12	E3T-FL14			
1 to 30 mm		Light- ON	E3T-FL21	E3T-FL23			
	1 to 15 mm	Dark-ON	E3T-FL22	E3T-FL24			

Note: 1- For pre-wired models with robotic cables add '-R' to the order code (example: E3T-FT21R 2M)

2- The distances are measured with reflector E39-R4 and reflective foil E39-R37-CA. For applications with shorter distances between the sensor and the reflector contact your Omron Automation and Safety representative. 3- Order reflector separately. Models with included reflectors are available.

# E3S-A Photoelectric Sensors

Quick Link

B232

omron247.com

## High Performance Small DC Sensors

- Enclosure meets NEMA 4X, 6 and IP67
- User-friendly features for ease of installation and use
- Timer/alarm/turbo aiming tool models available
- Light-ON/Dark-ON, switch selectable
- Mounting bracket E39-L69 supplied with horizontal sensors
- Mounting bracket E39-L70 supplied with vertical sensors
- Polarized retro-reflective sensors include E39-R1 reflector
- Through-beam sensors include both emitter and receiver
- Pre-wired versions have 2 m cable; M12 4-pin connector versions available



# E3K Photoelectric Sensors

Quick Link

B242

omron247.com

## Long-range Sensing for Door Control and Material Handling Applications

- AC/DC sensor for heavy-duty switching requirements
- Long sensing distances:
  - Retro-reflective: 10 m, includes E39-R1 reflector
  - Diffuse-reflective: 2 m
- Clean interior, easy-to-wire terminal strip
- Plug-in replaceable relay output
- Timer modules available
- Rated IP67, NEMA 4X, 6 for washdown



## Laser Position Verification Sensors with Long Range or Variable Spot Size

- Ideal for applications that cannot be solved with Fiber Sensors or Photoelectric Sensors
- Compact, lightweight sensing heads
- Slim DIN rail mounting amplifiers
- Simple setup with 3 types of tuning
- CMOS triangulation model E3NC-S detects regardless of surface or color
- EtherCAT communication available



## Ordering Information

### E3NC-L Sensing Heads

Quick Link

B289

omron247.com

Sensing method	Focus	Sensing distance	Spot diameter	Ratings	Connection	Model
Limited-reflective	Spot	70 ±15 mm	0.1 mm	Laser Class 1, IP65	2 m robot cable to amplifier	E3NC-LH01 2M
Diffuse-reflective	Variable spot	1200 mm max.	0.8 mm or larger			E3NC-LH02 2M
Coaxial Retro-reflective with MSR	Spot	8 m *	2mm at 1 m			E3NC-LH03 2M

\* These values apply when an E39-R21, E39-R22, E39-RS10, or E39-RS11 Reflector is used. A Reflector is not included. Purchase a Reflector separately to match the intended use of the Sensor.

### E3NC-L Amplifier Units

Inputs/outputs	Connection method	Connection media	E3NC-L Amplifier Model	
			NPN	PNP
1 In + 2 Out	Pre-wired 2 m	PVC cable	E3NC-LA21 2M	E3NC-LA51 2M
1 in + 1 Out	Wire-saving connector	E3X-CN cables	E3NC-LA7	E3NC-LA9
1 In + 1 Out	M8 Connector	XS3F-M8 cable	E3NC-LA24	E3NC-LA54
2 Out	Comm Unit for E3NW	E3X-CN02	E3NC-LA0	

### E3NC-S CMOS Sensing Heads

Quick Link

B292

omron247.com

Sensing method	Detected level difference	Sensing distance	Spot diameter	Ratings	Connection	Model
Distance-settable	35 to 50 mm: 1.5 mm; 50 to 100 mm: 3 mm	35 to 100 mm	0.5 mm	Laser Class 1, IP67	2 m robot cable to amplifier	E3NC-SH100 2M
	35 to 180 mm: 9 mm; 180 to 250 mm: 25 mm	35 to 250 mm	1 mm			E3NC-SH250 2M

### E3NC-S CMOS Amplifier Units

Inputs/outputs	Connection method	Connection media	E3NC-S Amplifier Model	
			NPN	PNP
1 In + 2 Out	Pre-wired 2 m	PVC cable	E3NC-SA21 2M	E23NC-SA51 2M
1 in + 1 Out	Connector	E3X-CN cables	E3NC-SA7	E3NC-SA9
1 In + 1 Out	M8 Connector	XS3F-M8 cable	E3NC-SA24	E3NC-SA54
2 Out	Comm Unit for E3NW	E3X-CN02	E3NC-SA0	

## Variable Laser Beam Sensors

The E3C-LDA sensors for high-speed gauging applications combine compact Class II laser sensing heads with slim DIN-mount amplifiers.

- Sensing heads offer variable focal point and optical axis alignment
- Safe Class II lasers require no special protective hardware
- Dual digital display on the amplifier simplifies setup and monitoring
- Selectable detection modes with response speed as fast as 100  $\mu$ s



## Ordering Information

### Sensing Heads

Sensing method	Beam shape	Sensing distance	Dimensions H x W x D mm	Model
Diffuse reflective	Spot, 0.8 mm max.	30 mm to 1 m	25 x 12.8 x 33	E3C-LD11
	Line, 33 mm L			E3C-LD21
	Area, 33 x 15 mm		27 x 13.2 x 36	E3C-LD31
Coaxial retro-reflective with mirror surface rejection	Variable spot (0.8 mm dia.)	Up to 7 m with E39-R12	25 x 12.8 x 39	E3C-LR11
	Line, 28 mm L	Up to 1.7 m with E39-R12		E3C-LR11 + E39-P31
	Area, 28 x 16 mm	Up to 900 mm with E39-R12		E3C-LR11 + E39-P41
	Fixed spot (2 mm dia.)	Up to 7 m with E39-R12		E3C-LR12

### Amplifiers

Connector	Description	Functions	Output ratings	Model	
				NPN output	PNP output
Pre-wired models	Analog + Discrete outputs	Area output, differential operation	1 to 5 VDC, 50 mA at 26.4 VDC	E3C-LDA11AN	E3C-LDA41AN
	Two discrete outputs	Area output, differential operation, self-diagnostics	2 x 50 mA at 26.4 VDC	E3C-LDA11	E3C-LDA41
	External input + Discrete output	Built-in counter, differential operation, remote setting	1 x 50 mA at 26.4 VDC	E3C-LDA21	E3C-LDA51
Connector	Two discrete outputs	Area output, differential operation, self-diagnostics	2 x 50 mA at 26.4 VDC	E3C-LDA6	E3C-LDA8
	External input + Discrete output	Built-in counter, differential operation, remote setting	1 x 50 mA at 26.4 VDC	E3C-LDA7	E3C-LDA9

### Connectors

Description	Compatible amplifiers	Cable length	Conductors	Model
Master connector (for first unit)	E3C-LDA6, E3C-LDA7, E3C-LDA8, E3C-LDA9	2 m	3	E3X-CN11
Slave connector (for second and additional units)			4	E3X-CN21
			1	E3X-CN12
			2	E3X-CN22



# F3ET2/F3EM2

## Photoelectric Sensor Light Grids

Quick Link

B634

omron247.com

### Non-Safety Light Grid with Analog or Discrete Output

Light grids provide reliable area monitoring in robust IP65 aluminum housing.

- Light grid detection area heights from 150 mm up to 2100 mm
- Optical synchronization for reliable operation without additional wiring
- Brackets included with light grids
- Connects with M12, 5-wire cable



F3ET2 [Quick Link](#) **B634** [omron247.com](http://omron247.com)

F3EM2 [Quick Link](#) **B633** [omron247.com](http://omron247.com)

### Ordering Information

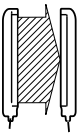
Sensor Type	Height (mm)	Pitch	Sensing Distance**	Number of Beams	Detectable Object Size	Discrete Output Models PNP/NPN	Analog Output Models 0-10 VDC (12 bits)
	150	5 mm	3 m	30	10 mm min.	F3ET2-005-150	F3EM2-005-150-AV
		18 mm	15 m	8	30 mm min.	F3ET2-018-150	F3EM2-018-150-AV
	300	5 mm	3 m	60	10 mm min.	F3ET2-005-300	F3EM2-005-300-AV
		18 mm	15 m	16	30 mm min.	F3ET2-018-300	F3EM2-018-300-AV
	450	5 mm	3 m	90	10 mm min.	F3ET2-005-450	F3EM2-005-450-AV
		18 mm	15 m	24	30 mm min.	F3ET2-018-450	F3EM2-018-450-AV
	600	5 mm	3 m	120	10 mm min.	F3ET2-005-600	F3EM2-005-600-AV
		18 mm	15 m	32	30 mm min.	F3ET2-018-600	F3EM2-018-600-AV
	900	5 mm	3 m	180	10 mm min.	F3ET2-005-900	F3EM2-005-900-AV
		18 mm	15 m	48	30 mm min.	F3ET2-018-900	F3EM2-018-900-AV
	1200	5 mm	3 m	240	10 mm min.	F3ET2-005-1200	F3EM2-005-1200-AV
		18 mm	15 m	64	30 mm min.	F3ET2-018-1200	F3EM2-018-1200-AV
	1500	5 mm	3 m	300	10 mm min.	F3ET2-005-1500	F3EM2-005-1500-AV
		18 mm	15 m	80	30 mm min.	F3ET2-018-1500	F3EM2-018-1500-AV
1800	5 mm	3 m	360	10 mm min.	F3ET2-005-1800	F3EM2-005-1800-AV	
	18 mm	15 m	96	30 mm min.	F3ET2-018-1800	F3EM2-018-1800-AV	
2100	18 mm	15 m	112	30 mm min.	F3ET2-018-2100	F3EM2-018-2100-AV	

\*\*Light-ON / Dark-ON selectable

\*\*The maximum sensing distance between the Transmitter and Receiver light grids

## Long Distance Sensor in Oil-Resistant, Metal Case

- Long sensing distances: 30 m through-beam; 3 m polarized retro-reflective; 2 m or 0.7 m diffuse reflective
- Rugged zinc die cast housing protects against vibration (10 Hz to 2 kHz) and shock (up to approx. 100 G)
- Meets IP67 and NEMA 4X, 6P for water washdown
- High visibility indicators for light incidence and stability
- Light-ON and Dark-ON operation selectable

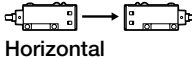
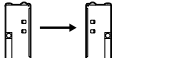
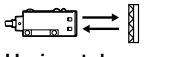
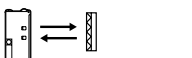
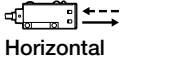
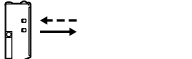

## Metal Body Sensors

Sensing type	Setup	Features	Light source	Sensing distance	Connection method	Model
Through-beam	 Horizontal	Includes E39-L102 mounting bracket	Infrared (880 nm)	30 m Using E39-S61 slits: 4 mm slit: 15 m 2 mm slit: 7 m 1 mm slit: 3.5 m 0.5 mm slit: 1.8 m	Pre-wired	E3S-CT11
	 Vertical	Includes E39-L103 mounting bracket			M12 4-pin connector	E3S-CT16
		Pre-wired			E3S-CT61	
					M12 4-pin connector	E3S-CT66
Retro-reflective	 Horizontal	Polarized; includes E39-R1 reflector and E39-L102 mounting bracket	Red (700 nm)	0 to 3 with E39-R1 reflector (included); Optional reflectors: E39-R2: 0 to 4 m E39-R3: 0 to 150 cm E39-R4: 0 to 75 cm E39-RSA: 5 to 35 cm E39-RSB: 5 to 60 cm	Pre-wired	E3S-CR11
	 Vertical	Polarized; includes E39-R1 reflector and E39-L103 mounting bracket			M12 4-pin connector	E3S-CR16
					Pre-wired	E3S-CR61
					M12 4-pin connector	E3S-CR66
Diffuse reflective	 Horizontal	includes E39-L102 mounting bracket	Infrared (880 nm)	0 to 70 cm	Pre-wired	E3S-CD11
	 Vertical	Includes E39-L103 mounting bracket			M12 4-pin connector	E3S-CD16
					Pre-wired	E3S-CD61
					M12 4-pin connector	E3S-CD66

## UV Power Monitor for Sterilizing and Curing Operations

- Monitor ultraviolet light (UV) intensity or wavelength to maintain effective levels for critical processes
- Compact monitors fit tight inspection spaces on existing machinery
- Built-in amplifier models detect incident UV light power in two ranges (1 to 30 mW/cm<sup>2</sup> or 0.2 to 3 mW/cm<sup>2</sup>) and provide a 1-5 V analog output
- Fiber-optic detection heads and separate amplifiers detect in two ranges (10 to 300 mW/cm<sup>2</sup> or 30 to 300 mW/cm<sup>2</sup>)
- Fiber-optic monitor available with judgment, answer-back and current/voltage analog outputs



J

## Photoelectric Sensor Mounting Brackets

- Brackets enhance mounting flexibility
- Protective mounts fortify sensors
- Height adjustable and rotating mounts available



## Reflectors Return Light to Retro-reflective Photoelectric Sensors and Photomicrosensors

- Corner cube reflectors return maximum light with minimal scattering
- Reflectors extend or shorten sensing distance
- Hard acrylic reflectors are backed by ABS plastic
- Easy-to-apply, adhesive-backed reflectors available
- Sensor data sheets show recommended reflector models



## Contents

Selection Guide		K-ii
<b>Fiber-optic Sensor Heads</b>		
E32	Standard Cylindrical Sensor Heads	K-1
E32	Square Shape Sensor Heads	K-2
E32	Miniature Sensor Heads	K-3
E32	Longer Distance Sensor Heads	K-4
E32	Built-in Lens Sensor Heads	K-5
E32	Robot Application Heads	K-5
E32	Chemical Resistant Sensor Heads	K-6
E32	Heat Resistant Sensor Heads	K-7
E32	Vacuum Resistant Sensor Heads	K-8
E32	Precision Detection Sensor Heads	K-9
E32	Area Monitoring Sensor Heads	K-10
E32	Special Application Sensor Heads	K-11

<b>Fiber-optic Sensor Amplifiers</b>		
E3X-HD	Easy-Teach Digital Amplifier	K-12
E3NX-FA	Advanced Functionality Amplifier	K-13
E3X-NA	Bar Graph Amplifiers	K-14
E3X-SD	Single Display Amplifiers	K-14
E3X-DA-S	High Function Amplifier	K-15
E3X-DA-SE-S	Digital Amplifier with One Button Teaching	K-16
E3X-MDA	Dual Fiber Amplifier	K-17
E3X-NA-F	Fast Response Amplifier	K-17
E3X-DAC-S	Color Mark Detection Amplifier	K-18
E3X-DAH-S	Infrared LED Amplifier	K-18
<b>Network Communication Interface Units</b>		
E3X-ECT/ E3X-CRT/ E3X-DRT21S/ E3X-DRT21/ E3X-CIF11	E3X Communication Units	K-19



## THE SIMPLICITY OF HIGH PERFORMANCE IN CHALLENGING AREAS

With over 500 different fiber heads we offer one of the most comprehensive fiber portfolios bringing reliable detection to smallest spaces or most challenging environments. The easy usage and auto adjustment features of the fiber amplifiers provide highest stability and performance reducing setup and adjustment times.



**Smaller size:**

Standard cylindrical fiber heads

**E32 Standard cylindrical**

- Easy installation and long sensor lifetime for all general applications
- High flex fibers and 90° models for fiber breakage prevention

**Square housing:**

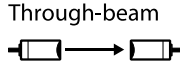

Through-beam

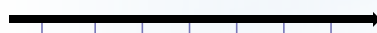

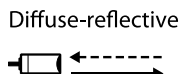

M4   4000 mm

Diffuse-reflective



M3   2100 mm

M4   490 mm

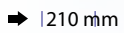
M6   1210 mm

**Longer distance:**

E32 Miniature









E32 Square



E32 Longer distance



**Special Applications**

<b>Heat, chemical vacuum resistant</b>	<b>Robotic applications</b>	<b>Area monitoring</b>	<b>Precision detection</b>	<b>Special application</b>
				
<b>E32 Harsh environment</b>	<b>E32 Robot</b>	<b>E32 Area monitoring</b>	<b>E32 Precision</b>	<b>E32 Special</b>
Heat resistant up to 400°C 	Robot fibers withstand over 1 million bending cycles	Area monitoring up to 70mm beam width 	Coaxial or limited reflective models, up to 100µm resolution, variable focal lenses or fine beam	Special solutions for liquid level, color, mark, wafer detection, etc.



Dual digital display amplifier

**E3X-HD**

- Easy 1-button teaching
- Auto-teaching during operation
- Auto power control for long term stability

Basic functionality:

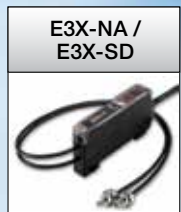

**E3NX-FA**

Advanced functionality:



**Special Applications**

**2 in 1 double amplifier**

**E3X-MDA**

AND, OR signal  
Infrared LED  
comparison of  
two input signals  
saving space and  
set-up time

**Fast response**

**E3X-NA-F**

Short turn on time  
of 20µs

**High stability**

**E3NX-FA**

Simple one button  
setting; detects  
large and low-  
reflection targets;  
light intensity and  
incidence  
compensation for  
stability.

**Color (RGB) amplifier**

**E3X-DAC-S**

White LED and RGB  
ratio comparison for  
challenging color  
and mark detection



**Infrared LED**





**E3X-DAH-S  
Infrared**

Infrared LED

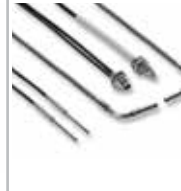
# Selection Table

## Fiber-optic Sensor Heads

Type	Cylindrical	Square shape	Miniature	Longer distance	Chemical resistant	Heat resistant
						
Model	E32 Standard Cylindrical	E32 Square Shape	E32 Miniature	E32 Longer Distance	E32 Chemical Resistant	E32 Heat Resistant
Key features	<ul style="list-style-type: none"> <li>• Standard and high-flex fibers</li> <li>• Sizes M3 to M6</li> </ul>	<ul style="list-style-type: none"> <li>• 3 or 4 mm thin housing</li> <li>• Models in X,Y or Z-axis</li> <li>• Direct mounting without bracket</li> </ul>	<ul style="list-style-type: none"> <li>• Sizes from 500 µm to 3 mm dia</li> <li>• Bendable sleeves</li> </ul>	<ul style="list-style-type: none"> <li>• Built in focal lenses</li> </ul>	<ul style="list-style-type: none"> <li>• Fluoroplastic cover or coating</li> </ul>	<ul style="list-style-type: none"> <li>• Heat resistant up to 400°C</li> </ul>
Through-beam	4000 mm	3000 mm	3000 mm	20 m	4000 mm	4000 mm
Diffuse-reflective	2100 mm	1260 mm	1260 mm	4000 mm	1260 mm	1680 mm



Type	Vacuum resistant	Robot applications	Precision detection	Area monitoring	Special application
					
Model	E32 Vacuum Resistant	E32 Robot	E32 Precision Detection	E32 Area Monitoring	E32 Special
Key features	<ul style="list-style-type: none"> <li>• Leakage rate of <math>1 \times 10^{-10}</math> Pa·m<sup>3</sup>/s max</li> </ul>	<ul style="list-style-type: none"> <li>• Free moving multicore fibers for &gt;1 Mio bending cycles</li> </ul>	<ul style="list-style-type: none"> <li>• Detection accuracy up to 100 µm</li> <li>• Coaxial fibers</li> <li>• Adjustable focal points</li> </ul>	<ul style="list-style-type: none"> <li>• Area monitoring up to 70 mm beam width</li> </ul>	<ul style="list-style-type: none"> <li>• Detection of special objects (wafer, liquid level, flat glass, print mark, etc.)</li> </ul>
Through-beam	2000 mm	3750 mm	4000 mm	4000 mm	4000 mm
Diffuse-reflective	—	1260 mm	300 mm	1050 mm	300 mm



\*1 Sensing distance varies depending on the amplifier used. These sensing distances were measured with the Giga mode of the E3NX-FA.





# Fiber-optic Amplifiers and Sensors

## Fiber-optic Amplifiers

Type	Easy Teach Digital	Advanced Functionality	Bar Graph/Single Display
			
Model	E3X-HD	E3NX-FA	E3X-NA, E3X-SD
Key features	<ul style="list-style-type: none"> <li>• Simple 1 button setting</li> <li>• Compensates for light reduction from grime, deterioration</li> </ul>	<ul style="list-style-type: none"> <li>• Longest sensing ranges</li> <li>• White LED display</li> <li>• Advanced Smart Tuning</li> <li>• Predictive Maintenance DPC</li> </ul>	<ul style="list-style-type: none"> <li>• Easy adjustment by potentiometer</li> <li>• Bar graph gain display (-NA)</li> </ul>
Response time (min.)	50 $\mu$ s	30 $\mu$ s	200 $\mu$ s

Type	High functionality	Easy Teach	Double Amplifier
			
Model	E3X-DA-S	E3X-DA-SE-S	E3X-MDA
Key features	<ul style="list-style-type: none"> <li>• High functionality signal processing (timer, counter, power tuning, etc.)</li> </ul>	<ul style="list-style-type: none"> <li>• 1 button object teaching</li> <li>• Auto teach during operation</li> </ul>	<ul style="list-style-type: none"> <li>• 2 inputs with AND, OR signal comparison</li> </ul>
Response time (min.)	1 ms (80 $\mu$ s in high speed mode)	1 ms	1 ms (130 $\mu$ s in high speed mode)

Type	High Speed	Color/Print Mark Detection	Infrared LED
			
Model	E3X-NA-F	E3X-DAC-S	E3X-DAH-S
Key features	<ul style="list-style-type: none"> <li>• Fastest response time of Omron fiber amplifiers</li> </ul>	<ul style="list-style-type: none"> <li>• White LED and RGB ratio comparison</li> </ul>	<ul style="list-style-type: none"> <li>• Infrared LED</li> </ul>
Response time (min.)	20 $\mu$ s	1 ms (60 $\mu$ s in super high speed)	1 ms (55 $\mu$ s in super high speed)





K

## Standard Cylindrical Sensor Heads

The standard cylindrical fiber-optic sensing heads provide reliable object detection, easy installation and long sensor lifetime for all general applications.

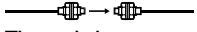
- High-flex fibers and 90° cable exit reduce fiber breakage
- Models with hexagonal back for simplified one-nut mounting
- Sizes M3 to M6

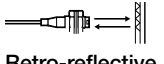
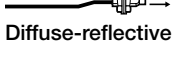

Sensor type	Size	Sensing distance (mm) <sup>1</sup>		Model	
		Standard	High-flex Fiber	Standard Fiber	High-flex
 Through-beam	M4	760	530	E32-TC200	E32-T11R
	M3	220	130	E32-TC200E	E32-T21R
 Through-beam	M4	—	530	—	E32-T11N 2M
 Retro-reflective	M6	250 <sup>2</sup>	—	E32-R21	—
 Diffuse-reflective	M6	300	170	E32-DC200	E32-D11R 2M
	M4	80	30	E32-D211 2M	E32-D211R 2M
	M3	80	30	E32-DC200E	E32-D21R 2M
 Diffuse-reflective	M6	—	170	—	E32-D11N 2M
 Diffuse-reflective	6 mm dia	110	45	E32-D14L	E32-D14LR

<sup>1</sup> Sensing distance measured with E3X-DA-SE-S family. Longer sensing distances can be achieved with the E3X-HD and E3NX-FA.

<sup>2</sup> Measured with E39-R3 reflector



Hi-flex multicore fibers for flexibility in installation without fiber breakage









Models with hexagonal back for simple one-nut mounting

## Square Shape Sensor Heads

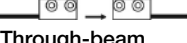
The fiber heads in square shaped housing provide fast and easy installation on flat surfaces.

- Models with sensing direction in X, Y or Z axis
- 3 or 4 mm thick housings for minimal height requirement
- Standard or high-flex fibers

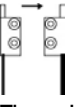

Sensor type	Size (mm)	Sensing distance (mm) <sup>*1</sup>		Model	
		Standard Fiber	High-flex Fiber	Standard Fiber	High-flex Fiber
 Through-beam	15 x 8 x 3	760	560	E32-T15X 2M	E32-T15XR 2M
 Through-beam	15 x 8 x 3	460	210	E32-T15Y 2M	E32-T15YR 2M
 Through-beam	15 x 8 x 3	460	480	E32-T15Z 2M	E32-T15ZR 2M
 Diffuse-reflective	15 x 10 x 3	300	170	E32-D15X 2M	E32-D15XR 2M
 Diffuse-reflective	15 x 10 x 3	100	40	E32-D15Y 2M	E32-D15YR 2M
 Diffuse-reflective	15 x 10 x 3	100	60	E32-D15Z 2M	E32-D15ZR 2M
 Through-beam	24.5 x 10 x 3	890	—	E32-A03-1 2M	—
	20.5 x 2 x 2	340	—	E32-A04-1 2M	—

<sup>\*1</sup> Sensing distance measured with E3X-DA-SE-S family. Longer sensing distances can be achieved with the E3X-HD and E3NX-FA.

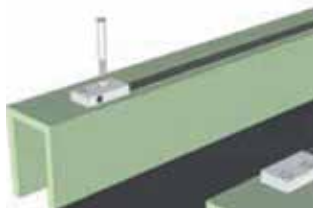

Space saving and fast mounting without additional brackets







Precise positioning during manufacturing for 90° optics to achieve minimal tolerance variations in optical output axis angle

## Miniature Sensor Heads

The miniature fiber heads provide high accuracy in smallest spaces and reliable detection of miniature objects.

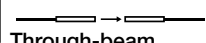

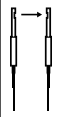
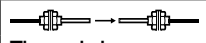
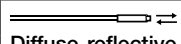
- Sizes from 500 µm diameter to 3 mm diameter
- Side view models with precision axis alignment for highest accuracy
- Bendable sleeves for precision positioning

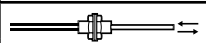
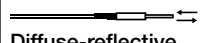
Sensor type	Size	Sensing distance (mm) <sup>1</sup>		Model	
		Standard Fiber	High-flex Fiber	Standard Fiber	High-flex Fiber
 Through-beam	3 mm dia	750	530	E32-T12 2M	E32-T12R
	2 mm dia	220	130	E32-T22	E32-T22R 2M
	1.5 mm dia	220	130	E32-T222 2M	E32-T222R 2M
	1 mm dia	—	130	—	E32-T223R 2M
 Through-beam	3 mm dia	460	210	E32-T14L	E32-T14LR
	2 mm dia	340	—	E32-A04	—
 Through-beam	1 mm dia	130	50	E32-T24	E32-T24R
 Through-beam	1.2 mm dia	750	530	E32-TC200B	E32-TC200BR
	0.9 mm dia	220	130	E32-TC200F	E32-TC200FR
 Diffuse-reflective	3 mm dia	80	30	E32-D22 2M	E32-D22R
	2 mm dia	75	40	E32-D32	E32-D32R 2M
	1.5 mm dia	—	30	—	E32-D22B
 Diffuse-reflective	2 mm dia	30	15	E32-D24	E32-D24R
 Diffuse-reflective	2.5 mm dia	300	170	E32-DC200B <sup>3</sup>	E32-DC200BR <sup>3</sup>
	1.2 mm dia	80	30	E32-DC200F	E32-DC200FR
 Diffuse-reflective	0.8 mm dia	—	16	—	E32-D33
	0.5 mm dia	—	3	—	E32-D331

<sup>1</sup> Sensing distance measured with E3X-DA-SE-S family. Longer sensing distances can be achieved with the E3X-HD and E3NX-FA.

<sup>2</sup> Models with 40 mm sleeve instead of 90 mm sleeve are available by adding '4' to the order code at the end, e.g. E32-TC200B4







<sup>3</sup> Sleeve cannot be bent

## Longer Distance Sensor Heads

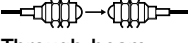
With built-in focal lenses the longer distance fiber heads provide enhanced operational stability in dusty environments or long distance applications

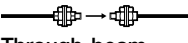
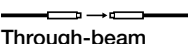
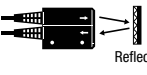
- Sensing distance up to 20 m
- Built-in focal lens
- Sizes from 2 mm dia to M14 dia

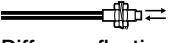

Sensor type	Size	Sensing distance (mm) <sup>1</sup>	Model
 Through-beam	M14	20000	E32-T17L
 Through-beam	25.2 x 10.5 x 8 mm	3400	E32-T14
 Through-beam	M4	1330	E32-T11L
	M3	680	E32-TC200A
 Through-beam	3 mm dia	1330	E32-T12L
	2 mm dia	440	E32-T22L
 Convergent-reflective	21.4 x 27 x 10 mm	1500 <sup>2</sup>	E32-R16
 Diffuse-reflective	22 x 17.5 x 9 mm	700	E32-D16
 Diffuse-reflective	M6	400	E32-D11L
	M4	130	E32-D21L
 Diffuse-reflective	3 mm dia	450	E32-D12

<sup>1</sup> Sensing distance measured with E3X-DA-SE-S family. Longer sensing distances can be achieved with the E3X-HD and E3NX-FA.

<sup>2</sup> Measured with E39-R1

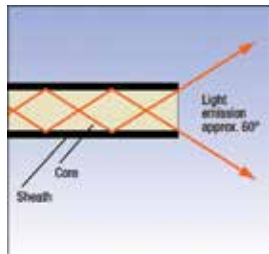

Light emission of conventional fibers

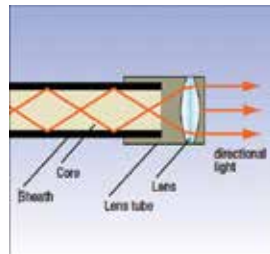

With built-in focal lenses, longer sensing distances can be achieved up to 5 times longer compared to conventional sensors

## Built-in Lens Sensor Heads

- Achieve high power, focused beam detection without the need to attach a lens
- 15° beam aperture angle
- Standard or Flexible fiber options
- M4 through-beams and M6 Diffuse reflective fibers



Sensor type	Size	Sensing distance (mm) <sup>1</sup>	Model
Through-beam	M4	4,000	E32-LT11 2M
		4,000	E32-LT11R 2M
	M4 Hex Shape	4,000	E32-LT11N 2M
Diffuse-reflective	M6	860	E32-LD11 2M
		840	E32-LD11R 2M
	M6 Hex Shape	840	E32-LD11N 2M

<sup>1</sup> Sensing distance measured with E3X-HD family. Longer sensing distances can be achieved with the E3NX-FA.





# E32 Fiber-optic Sensor Heads

## Robot Application Sensor Heads

For applications on frequently or fast moving parts, the robot fibers reduce the risk of fiber breakage with a guaranteed operational life of more than 1 million bending cycles

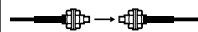
- Free moving multicore fibers for more than 1 million bending cycles
- Square shapes for easy surface installation
- Cylindrical sizes from 1.5 mm dia to M6

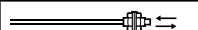
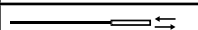

Sensor type	Size	Sensing distance (in mm) <sup>1</sup>	Model
 Through-beam	M4	680	E32-T11
	M3	200	E32-T21
 Through-beam	3 mm dia	680	E32-T12B 2M
	2 mm dia	200	E32-T221B 2M
	1.5 mm dia	200	E32-T22B
 Through-beam	15 x 18 x 3 mm	680	E32-T15XB
 Diffuse-reflective	M6	170	E32-D11
	M4	70	E32-D21B
	M3	30	E32-D21
 Diffuse-reflective	1.5 mm dia	30	E32-D22B
 Diffuse-reflective	15 x 10 x 3 mm	170	E32-D15XB 2M

<sup>1</sup> Sensing distance measured with E3X-DA-SE-S family. Longer sensing distances can be achieved with the E3X-HD and E3NX-FA.



## Chemical Resistant Sensor Heads

The chemical resistant fibers provide long sensor lifetime in areas with frequent cleaning, usage of chemicals and higher temperatures.

- Fluoroplastic cover for highest chemical resistance
- Temperature resistance up to 200°C

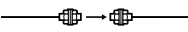
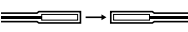
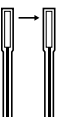
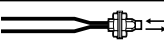
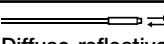

K

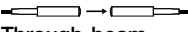
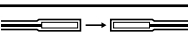
Sensor type	Size	Sensing distance (mm) <sup>1</sup>	Cover material	Model
 Through-beam	M4	680	Fluororesin coating	E32-T11U
 Through-beam	5 mm dia	3,000	Fluororesin cover	E32-T12F
 Through-beam	5 mm dia	1,400	Fluororesin cover	E32-T14F
 Diffuse-reflective	M6	170	Fluororesin coating	E32-D11U
 Diffuse-reflective	6 mm dia	85	Fluororesin cover	E32-D12F
 Diffuse-reflective	6 mm dia	40	Fluororesin cover	E32-D14F
 Through-beam	6 mm dia	700	Fluororesin cover Heat resistant to 200°C	E32-T81F-S
 Through-beam	5 mm dia	3,000	Fluororesin cover Heat resistant to 150°C	E32-T51F

<sup>1</sup> Sensing distance measured with E3X-DA-SE-S family. Longer sensing distances can be achieved with the E3X-HD and E3NX-FA.



Enhanced temperature resistant models



The fluororesin cover provides highest chemical resistance for longest lifetime in frequently cleaned environments like aseptic filling in pharmaceutical applications

## Heat Resistant Sensor Heads

The wide range of heat resistant fibers provides long sensor lifetime with highest protection in demanding environments

- Heat resistant up to 400°C
- Sizes from 2 mm dia to M6
- Models for long distances or high detection accuracy

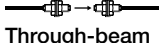
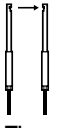
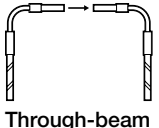
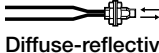
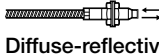
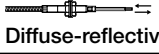
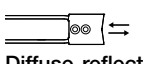

Sensor type	Size	Sensing distance (mm) <sup>*1</sup>	Temperature Range	Model	
				For E3X-DA-S teachable amplifier	For E3X-NA amplifier with potentiometer adjustment
 Through-beam	M4	450	-40°C to 150°C	E32-T51	
	M4	280	-40°C to 200°C	E32-T81R-S	
	M4	450	-60°C to 350°C	E32-T61-S	
 Through-beam	2 mm dia	230	-40°C to 150°C	E32-T54	
 Through-beam	3 mm dia	1300	-40°C to 200°C	E32-T84S-S	
 Diffuse-reflective	M6	230	-40°C to 150°C	E32-D51	
	M6	280	-40°C to 200°C	E32-D81R-S	E32-D81R
 Diffuse-reflective	M6	150	-60°C to 350°C	E32-D61-S	E32-D61
 Diffuse-reflective	M4	60	-40°C to 400°C	E32-D73-S	E32-D73
 Diffuse-reflective	23 x 20 x 9 mm	35	-40°C to 150°C	E32-A09H 2M	
	30 x 24 x 9 mm	25	-40°C to 300°C	E32-A09H2 2M	
 Diffuse-reflective	36 x 18 x 5 mm	18	-40 to 300°C	E32-L66	

\*1 Sensing distance measured with E3X-DA-SE-S family. Longer sensing distances can be achieved with the E3X-HD and E3NX-FA.

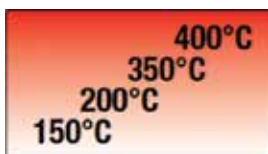

The temperature range optimized material selection provides best application fit and value - performance ratio.



Stainless steel spiral coating for flexibility with highest mechanical protection.





## Vacuum Resistant Sensor Heads

For applications in cleanest and hot environments the vacuum resistant fibers and connecting flanges provide long operational lifetime and vacuum integrity.

- Leakage rate of  $1 \times 10^{-10}$  Pa\*M<sup>3</sup>/s max
- Heat resistance up to 200°C
- Detergent resistant fluoro-resin or stainless steel fiber sheath

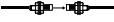

## Sensor

Sensor type	Size	Sensing distance (mm) <sup>1</sup>	Temperature Range	Model
 Through-beam	M4	200	-40°C to 120°C	E32-T51V 1M
 Through-beam	3 mm dia	130	-40°C to 120°C	E32-T54V 1M
	3 mm dia	480	-60°C to 200°C	E32-T84SV 1M

<sup>1</sup> Sensing distance measured with E3X-DA-SE-S family. Longer sensing distances can be achieved with the E3X-HD and E3NX-FA.

## Flange

Type	Size	Model
4 channel flange	80 x 80 x 49 mm	E32-VF4
1 channel flange	96 x 30 dia mm max.	E32-VF1
Flange-to-amplifier connection fiber	2 m length	E32-T10V 2M

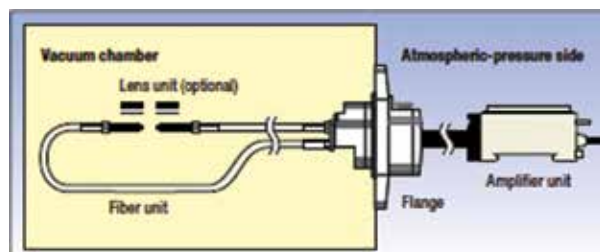

The vacuum resistant fiber heads and flanges are sealed to prevent gas leakage into vacuum areas

## Precision Detection Sensor Heads

Highest precision in design and manufacturing of the fibers and focal lenses ensure highest beam and spot accuracy allowing the detection of smallest objects and height differences of less than 100 µm.

- Coaxial fibers with focal lenses for spot diameters of 100 µm
- Through-beam models with highly focused beam and precise optical axis alignment
- Limited reflective models for height difference detection of less than 100 µm



Sensor type	Preferred usage	Size	Key feature	Sensing distance (mm) <sup>1</sup>	Model
Through-beam	Precise thin object detection / accurate positioning	3 mm dia	- High precision optical axis adjustment - Very focused beam	1900	E32-T22S
Through-beam		3 mm dia		890	E32-A03 2M
Through-beam		3 mm dia		340	E32-A04 2M
Diffuse-reflective	Very small object detection	M6	—	300	E32-CC200 <sup>2</sup>
Diffuse-reflective		M3	Spot dia 0.5 mm	20	E32-C31 2M
Diffuse-reflective		M3	Spot dia 0.2 mm	17	E32-C41 + E39-F3B
Diffuse-reflective		M3	Spot dia 0.1 mm	7	E32-C41 + E39-F3A-5
Diffuse-reflective		3 mm dia	—	150	E32-D32L
Diffuse-reflective		2 mm dia	—	75	E32-D32 <sup>2</sup>
Diffuse-reflective		M6	- 90° cable exit - Hexagonal back	170	E32-C11N 2M
Diffuse-reflective		M3		25	E32-C31N 2M
Diffuse-reflective		2 mm dia	Spot dia 0.5 to 1 mm	6-15 mm adjustable	E32-D32 + E39-F3A
Diffuse-reflective		2 mm dia	Spot dia 0.1 to 0.6 mm	6-15 mm adjustable	E32-C42 + E39-F3A
Diffuse-reflective	Precision height difference detection / flat surface detection	23 x 20 x 9 mm	—	35	E32-A09 2M
Convergent-reflective		16 x 18 x 4 mm	—	7.2	E32-L25L <sup>2</sup>
Convergent-reflective		20 x 20 x 5 mm	—	3.3	E32-L25
Diffuse-reflective		18 x 20 x 4 mm	Precise spot e.g. for detection of a flat / reflective surface	4	E32-L24L <sup>2</sup>
Diffuse-reflective	Object detection in front of background	20.5 x 14 x 3.8 mm	Wide beam e.g. for object detection on a flat surface	15	E32-L16-N 2M

<sup>1</sup> Sensing distance measured with E3X-DA-SE-S family. Longer sensing distances can be achieved with the E3X-HD and E3NX-FA.

<sup>2</sup> A high flex cable version is available. Add 'R' to the order code, e.g. E32-CC200R

## Area Monitoring Sensor Heads

The area monitoring fibers allow the detection of objects passing anywhere through the detection range and can be used for height comparisons of different objects.

- Area monitoring up to 70 mm height
- Multi-beam sensor with 4 separate heads for flexible detection points
- Standard or high flex fibers

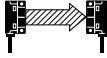
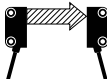
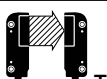
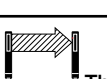
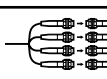
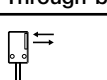

Sensor type	Area height (mm)	Sensing distance (mm) <sup>1</sup>		Model	
		Standard Fiber	High-flex Fiber	Standard Fiber	High-flex Fiber
 Through-beam	10	2800	–	E32-T16	–
 Through-beam	11	1100	840	E32-T16P	E32-T16PR
 Through-beam	30	1800	1300	E32-T16W	E32-T16WR
	50	–	1800	–	E32-ET16WR-2
	70	–	2000	–	E32-ET16WR-1
 Through-beam	11	1000	750	–	E32-T16JR
 Through-beam	4 separate M3 heads	610	–	E32-M21	–
 Diffuse-reflective	11	–	150	–	E32-D36P1

<sup>1</sup> Sensing distance measured with E3X-DA-SE-S family. Longer sensing distances can be achieved with the E3X-HD and E3NX-FA.

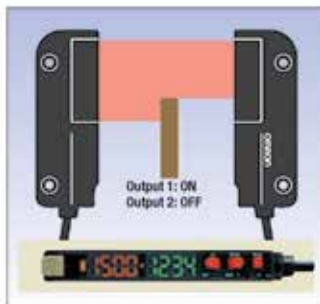

The two outputs of the E3X-DA-S can be used to detect two different light levels

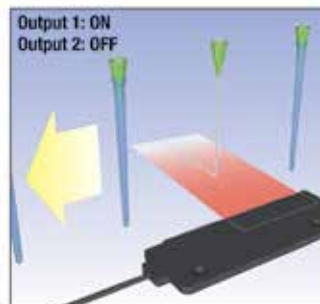

In combination with the twin output function of the E3X-DA-S amplifier, the diffuse reflective area monitoring fibers can detect very small objects (e.g. needles) and a second state (e.g. cover present). The area beam compensates for position variations at high speed.

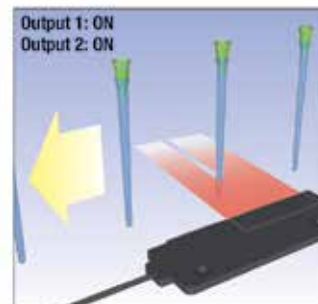









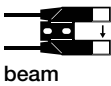

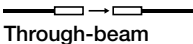

## Special Application Sensor Heads

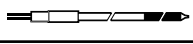
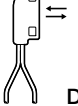
For a wide range of special applications, the task optimized fiber heads provide best fitting sensing performance and adaptation to environmental requirements.

- Detection of special objects (liquids, labels on foils, etc.)
- Fiber heads ideal for color mark detection
- Fiber heads optimized for special tasks (wafer mapping, flat glass, etc.)

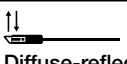
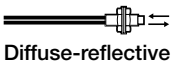

Sensor type		Size	Sensing distance (mm) <sup>1</sup>	Comment	Model
 Through-beam	Fork shape	36 x 24 x 8 mm	10	–	E32-G14
 Through-beam	Oil-resistant	M8	4000	IP68 oil resistance - Vacuum resin filling and fluoro-resin cable	E32-T11NF 2M
 Through-beam	Wafer mapping	3 mm dia	1900	–	E32-T22S
 Through-beam		3 mm dia	1300	–	E32-T24S
 Through-beam		3 mm dia	890	–	E32-A03 2M
 Through-beam		2 mm dia	340	–	E32-A04 2M
 Liquid level sensor	Liquid level sensor	6 mm dia	Liquid contact	Liquid level contact	E32-D82F1
 Diffuse-reflective		15 x 23.5 x 5 mm	Tube contact	Liquid level detection through transparent tube or container	E32-D36T 2M
 Diffuse-reflective	Glass detection	21 x 16.5 x 4 mm	8 mm	Metal housing	E32-A10 2M
		20.5 x 14 x 3.8 mm	15 mm	Plastic housing	E32-L16-N 2M
	Glass detection in hot environment	36 x 18 x 5.5 mm	18 mm	Heat resistant up to 300°C	E32-L66
 Convergent-reflective	Glass detection in wet processes	38.5 x 39 x 17.5 mm	8 to 20 (recommended: 11 mm)	- Heat resistant up to 85°C - Recommended usage with 'tough mode' of E3X-DA-S	E32-L11FS 2M
 Convergent-reflective	Label detection	20 x 20 x 5 mm	7.2	–	E32-L25L
		 Diffuse-reflective	18 x 20 x 4 mm	4	–
 Diffuse-reflective	Color/print mark detection	M6	300	Recommended for standard color and color mark detection	E32-CC200
 Diffuse-reflective		29 x 25.5 x 11.2	55	Recommended for challenging color and color mark detection	E32-L15 2M
		23 x 20 x 9 mm	35		E32-A09 2M

<sup>1</sup> Sensing distance measured with E3X-DA-SE-S family. Longer sensing distances can be achieved with the E3X-HD and E3NX-FA.

## Easy-Teach Digital Amplifier

Fiber-optic amplifier provides ultra-stable performance and smart tuning for high-speed, reliable input to open protocol industrial networks.

- Simple one-button smart tuning for sensor threshold and light intensity
- Confirm settings, status with dual display and indicators on control buttons
- Automatic compensation for large objects and low reflectance dark targets
- Smart power control function compensates for grime build-up and LED deterioration
- EtherCAT and CompoNet high-speed open network communication interfaces available



K

## Sensor Amplifiers

Item	Maximum connectable units	Connection method	NPN output model	PNP output model
Standard models	16 units	Pre-wired, 2 m cable	E3X-HD11 2M	E3X-HD41 2M
	16 units	Wire-saving connector	E3X-HD6	E3X-HD8
M8 models	16 units	M8 4-pin connector (XS3F Series)	E3X-HD14	E3X-HD44
Network models	16 units (E3X-CRT CompoNet); 30 units (E3X-ECT EtherCAT)	Communications unit	E3X-HD0	

## Wire-saving Connectors

Item	Cable length	Number of conductors	Function	Model
Master connector	2 m	3	First amplifier, with power line	E3X-CN11
Slave connector		1	Second and subsequent amplifiers	E3X-CN12
Cordless slave connector	--	--	Use with amplifiers connected to a communication interface unit	E3X-CN02

## Network Communication Interface Units

Network type	Applicable Fiber Amplifiers	Model
CompoNet	E3X-HD0, E3X-MDA0, E3X-DA0-S	E3X-CRT
EtherCAT		E3X-ECT

## Advanced Functionality Amplifier

The E3NX-FA amplifier is the best choice for even the most challenging fiber applications in terms of long sensing distance, small object detection or high speed processes.

- Easy calibration with Smart Tune allows for quick and stable setup
- New N-Smart technology provides significant improvements in sensing distance, minimum object detection and speed
- Straightforward sensor status information with Solution Viewer and Change Finder function
- EtherCAT communication unit for high-speed field bus connectivity



## Sensor Amplifiers

Item	Connection method	Inputs/outputs	Model	
			NPN output	PNP output
Standard models	Pre-wired (2 m)	1 output	E3NX-FA11 2M	E3NX-FA41 2M
	Wire-saving connector	1 output	E3NX-FA6	E3NX-FA8
Advanced models	Pre-wired (2 m)	2 outputs + 1 input	E3NX-FA21 2M	E3NX-FA51 2M
	Wire-saving connector	1 output + 1 input	E3NX-FA7	E3NX-FA9
		2 outputs	E3NX-FA7TW	E3NX-FA9TW
Model for sensor communications unit	Connector for sensor communications unit	2 outputs	E3NX-FA0	

## Wire-saving Connectors

Item	Cable length	Number of conductors	Applicable Fiber Amplifier Units	Model
Master connector	2 m	4	E3NX-FA7, E3NX-FA7TW, E3NX-FA9, E3NX-FA9TW	E3X-CN21
Slave connector		2		E3X-CN22
Master connector		3	E3NX-FA6, E3NX-FA8	E3X-CN11
Slave connector		1		E3X-CN12

## Network Communication Interface Units

Type	Model
Sensor communications unit for EtherCAT	E3NW-ECT
Sensor dispersion unit	E3NW-DS

# E3X-NA Fiber-optic Sensors

Quick Link

B328

omron247.com

## Simple, Easy-to-Read Amplifier with Bar Graph Display

- Streamlined features provide basic sensing immediately after plug-in
- Easy push button teach with or without workpiece
- Pre-wired (2 m cable) and wire-saving connector models available
- IP66 water-resistant models available



## Ordering Information

Type	Item	Model	
		NPN output	PNP output
Pre-wired (2 m)	Standard	E3X-NA11	E3X-NA41
Pre-wired (2 m)	Enhanced water resistance	E3X-NA11V 2M	E3X-NA41V 2M
Connector	Standard (fiber amplifier connector) <sup>1</sup>	E3X-NA6	E3X-NA8
Connector	Enhanced water resistance (M8 4-pin connector)	E3X-NA14V	E3X-NA44V

<sup>1</sup> Order connector separately, see E3X-DA-S.

# E3X-SD Fiber-optic Sensors

Quick Link

B334

omron247.com

## High Performance Amplifier with Single Digital Display

- Large, 6 mm wide digital display provides read-out of incident and operating level
- Incident settings and management can be performed reliably with fine tune adjustment
- Connectivity for up to 16 amplifiers
- Rated IP50



## Ordering Information

Type	Item	Model	
		NPN output	PNP output
Pre-wired (2 m)	Standard	E3X-SD21 2M	E3X-SD51 2M
Connector	Standard (fiber amplifier connector) <sup>1</sup>	E3X-SD6	E3X-SD8

<sup>1</sup> Order connector separately, see E3X-DA-S.

## High Function Digital Amplifier

Advanced timing, LED power control and signal processing functionality providing highest detection accuracy and stability even for the most challenging objects and settings.

- Power tuning function to adjust the received light to a maximum, minimum or pre-defined value
- Auto power and threshold adjustment functions for highest operational stability
- Two outputs for window monitoring or two level detections (e.g. object + object state change)



## Amplifier

Item	Function								Model	
	Power Tuning	Timer	Auto-threshold compensation (ATC)	Twin output	External input	Differential operation	Wet process 'tough mode'	Power saving 'Eco' functions (display/LED off)	NPN output	PNP output
Pre-wired	Yes	Yes	Yes	Yes	Yes	Yes	Yes	Yes	E3X-DA21-S 2M	E3X-DA51-S 2M
Fiber amplifier connector <sup>1</sup>	Yes	Yes	Yes	Yes - selectable	Yes	Yes	Yes	Yes	E3X-DA7-S	E3X-DA9-S

<sup>1</sup> Order E3X-CNxx connector separately below.

## Wire-saving Connectors

Item	Cable length	Number of conductors	Function	Compatible sensor amplifiers	Model
Master connector	2 m	3	First amplifier, with power line	E3X-DA7F-S, E3X-DA9F-S, E3X-DA6SE-S, E3X-DA8SE-S, E3X-DA6-S, E3X-DA8-S, E3X-DAG6-S, E3X-DAG8-S, E3X-DAB6-S, E3X-DAB8-S, E3X-DAH6-S, E3X-DAH8-S, E3X-DAC6-S, E3X-DAC8-S, E3X-SD6, E3X-SD8, E3X-NA6, E3X-NA8, E3X-NA14V, E3X-NA44V, E3X-HD6, E3X-HD8, E3NX-FA6, E3NX-FA8	E3X-CN11
Slave connector		1	Second and subsequent amplifiers		E3X-CN12
Master connector		4	First amplifier, with power line	E3X-DA7-S, E3X-DA9-S, E3X-DA6TW-S, E3X-DA8TW-S, E3X-DA6RM-S, E3X-DA8RM-S, E3X-DA6AT-S, E3X-DA8AT-S, E3X-MDA6, E3X-MDA8, E3X-DA6E-S, E3X-DA8SE-S, E3NX-FA7, E3NX-FA7TW, E3NX-FA9, E3NX-FA9TW	E3X-CN21
Slave connector		2	Second and subsequent amplifiers		E3X-CN22
Cordless slave connector	--	--	Use with amplifiers connected to a communication interface unit	E3X-HD0, E3X-DA0-S, E3X-MDA0	E3X-CN02



## Digital Amplifier With One Button Teaching

E3X-DA-SE-S allows easy one button setting and provides the best value to performance ratio for standard applications.

- Auto-teaching during machine operation
- Digital dual display for incident level and threshold
- Object or 2-point teaching within a few seconds



## Amplifier

Item	Model	
	NPN output	PNP output
Pre-wired	E3X-DA11SE-S	E3X-DA41SE-S
Fiber amplifier connector <sup>1)</sup>	E3X-DA6SE-S	E3X-DA8SE-S

<sup>1)</sup> Order connector separately.

## Amplifier Connectors

Shape	Type	Comment	Model
	Fiber amplifier connector	2 m PVC cable	E3X-CN21
		30 cm PVC cable with M12 plug connector (4 pin)	E3X-CN21-M1J 0.3M
		30 cm PVC cable with M8 plug connector (4 pin)	E3X-CN21-M3J-2 0.3M

<sup>1)</sup> Order connector separately. For M8 connector models see E3X-DA-S.



### 1-button auto-teaching

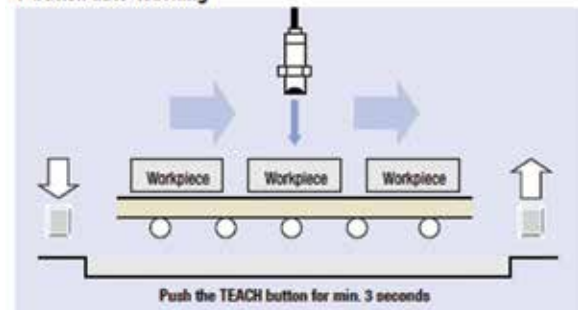

### 2-point teaching

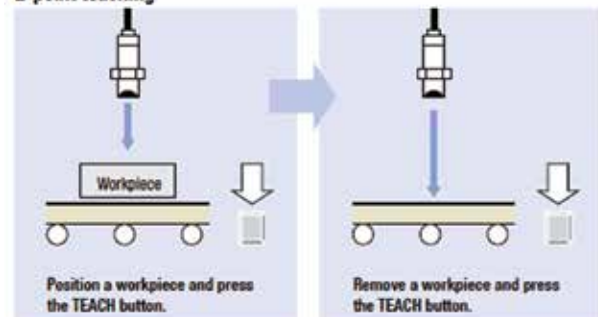

## Dual Fiber Amplifier

E3X-MDA incorporates 2 digital fiber amplifiers in one slimline housing. For applications requiring the detection of two objects simultaneously the E3X-MDA provides an easy to use operation saving space and set-up time.

- Two digital amplifiers in one slimline housing
- Twin output models – on/off or area (between two threshold values)
- Signal comparison functions (AND, OR, etc.)



Item	Function	Model	
		NPN output	PNP output
Pre-wired	AND/OR output	E3X-MDA11	E3X-MDA41
Fiber amplifier connector <sup>*1</sup>	AND/OR output	E3X-MDA6	E3X-MDA8
Communication model	AND/OR output	E3X-MDA0	

<sup>\*1</sup> Order E3X-CNxx connector separately, see E3X-DA-S.

## Fast Response Digital Amplifier with Potentiometer

The E3X-NA-F provides a very fast response time and is the ideal amplifier for high speed detection applications.

- Short turn on time of only 20  $\mu$ s
- Easy adjustment with potentiometer



Shape	Model	
	NPN output	PNP output
Pre-wired	E3X-NA11F	E3X-NA41F 2M

## Color (RGB) Digital Fiber Amplifier

The E3X-DAC-S detects the color and returned light intensity of a mark or object and compares it with a stored RGB ratio or intensity value. The RGB ratio or contrast difference allows the stable detection of differently colored, black, grey or white marks or objects.

- White LED for color independence
- Fast response time of 60  $\mu$ s
- Timer function for variable ON or OFF delay up to 5 seconds
- Remote teaching or easy one-button teaching



K

### Pre-wired

Item	Functions	Model (for pre-wired types with 2 m cable)	
		NPN output	PNP output
Standard models	Timer, response speed change	E3X-DAC11-S 2M	E3X-DAC41-S 2M
Advanced models	Standard models + simultaneous determination (2 colors) AND/OR output, remote setting	E3X-DAC21-S 2M	E3X-DAC51-S 2M
	Standard models + 4-color detection AND/OR output, bank switching	ESX-DAC21B-S 2M	E3X-DAC518-S 2M

### Connector Versions

Item	Functions	Model	
		NPN output	PNP output
Standard models (fiber amplifier connector) <sup>*1</sup>	Timer, response speed change	E3X-DAC6-S	E3X-DAC8-S

<sup>\*1</sup> Order connector separately, see E3X-DA-S.

## Digital Amplifier with Infrared LED

The digital fiber amplifiers with infrared LED are ideal for water detection applications or where visible light is not desired.

- Infrared LED
- LED power control and signal processing function



### Pre-wired

Item	Model (for pre-wired types with 2 m cable length)	
	NPN output	PNP output
Infrared light	E3X-DAH11-S	E3X-DAH41-S

### Connector Versions

Item	Model	
	NPN output	PNP output
Infrared light (fiber amplifier connector) <sup>*1</sup>	E3X-DAH6-S	E3X-DAH8-S

<sup>\*1</sup> Order connector separately, see E3X-DA-S.

### Reduced Wiring Solution to Interface with Open Communication Networks

Build efficient sensor input slave blocks using E3X Communication Interface Units and multiple E3X sensors. This solution reduces wiring, saves space and shortens setup time.



- EtherCAT, CompoNet, DeviceNet and serial communication units available
- Connect up to 16 fiber-optic sensors to each unit (up to 30 with EtherCAT)
- Supports explicit message communications
- Use E3X-CN02 Cordless Slave Connector for each sensor
- Remote setting, monitoring and operating through CX-Integrator software
- Mobile Programming Console for simple setting and monitoring locally

### Network Communication Interface Units

Network type	Maximum connectable amplifiers	Compatible sensor amplifiers	Model
EtherCAT	30 units	E3X-HD0, E3X-MDA0, E3S-DA0-S	E3X-ECT
CompoNet	16 units	E3X-HD0, E3X-MDA0, E3S-DA0-S	E3X-CRT
DeviceNet	16 units	E3X-DA7-S, E3X-DA9-S, E3X-DA6-S, E3X-DA8-S, E3X-DAG6-S, E3X-DAG8-S, E3X-DAB6-S, E3X-DAB8-S, E3X-DAH6-S, E3X-DAH8-S, E3X-DA6RM-S, E3X-DA8RM-S, E3X-DA6TW-S, E3X-DA8TW-S, E3X-DA6AT-S, E3X-DA8AT-S, E3X-MDA6, E3X-MDA8, E3C-LDA11, E3C-LDA41, E2C-EDA11, E2C-EDA41	E3X-DRT21S
	16 units	E3X-DA6, E3X-DA8, E3X-DAB6, E3X-DAB8, E3X-DAG6, E3X-DAG8, E3X-DA6TW, E3X-DA8TW, E3X-DA6-P	E3X-DRT21 SVER3
Serial RS-422	16 units	E3X-DA6, E3X-DA8, E3X-DAB6, E3X-DAB8, E3X-DAG6, E3X-DAG8, E3X-DA6TW, E3X-DA8TW, E3X-DA6-P	E3X-CIF11

Note: The E3NX-FA is not compatible with the above devices. Please use the E3NW EtherCAT device with the E3NX-FA series.

### Connector

Item	Function	Model
Cordless slave connector	Replaces individual cabling for network communications	E3X-CN02

## Contents

Selection Guide		L-ii
<b>Inductive Proximity Sensors</b>		
<b>Standard Cylindrical</b>		
E2E	Standard, inductive AC, DC 2-Wire, DC 3-Wire	L-1
E2B	Standard Environment DC 3-Wire	L-3
E2A	Increased Range DC Inductive	L-4
E2EM	DC 2-Wire, 2x CENELEC Distance, IP67	L-5
E2A3	DC 3-Wire, up to 3x CENELEC distance	L-6
E2E2	DC 2-Wire up to 1.5x CENELEC distance	L-7
E2E2	DC 3-Wire, IP67 at 1200 psi	L-8
E2E2	AC 2-Wire, IP67 at 1200 psi	L-10
<b>Miniature/Block Style/Separate Amplifier</b>		
E2E	Miniature DC 3-Wire Cylindrical	L-11
E2EC	Miniature, 0.4 m cable between head and amp	L-12
TL-W	Rectangular block, DC 2-Wire and DC 3-Wire	L-13
E2Q5	Long distance, square head inductive	L-14
E2S	Subminiature block style	L-14
<b>Capacitive</b>		
E2K-X	Threaded cylindrical, standard sizes	L-15
E2K-C	Adjustable Distance Cylindrical	L-16
E2K-F	Flat rectangular, built-in amplifier	L-17
E2K-L	Liquid level detector, direct pipe mounting	L-17

<b>Harsh Environment</b>		
E2F	Chemical-Resistant plastic cylindrical inductive sensors	L-18
E2FM	All-stainless steel, inductive sensors	L-19
E2EH	High temperature, IP69K compliant and detergent resistant ideal for food and beverage industry	L-21
E2E-U	Oil-resistant DC 2-Wire	L-22
E2EQ	Weld spatter resistant face, inductive	L-22
E2KQ-X	Chemical resistant with fluororesin coating	L-23
E2FQ	Chemical resistant with fluororesin coating	L-23
E2C-EDA	High-precision positioning, inductive	L-24
<b>Special Application</b>		
E2EV	Detect all metals at equal distance	L-25
E2CY	Detects aluminum, inductive	L-25
E2EY	Detect only non-ferrous metals	L-26
E2EZ	Resists metal chip accumulation	L-26



# Proximity Sensors

## FOR MACHINES THAT NEVER STOP

Our proximity sensors are designed and tested to ensure a long service life and achieve maximum machine availability even in the harshest environments.

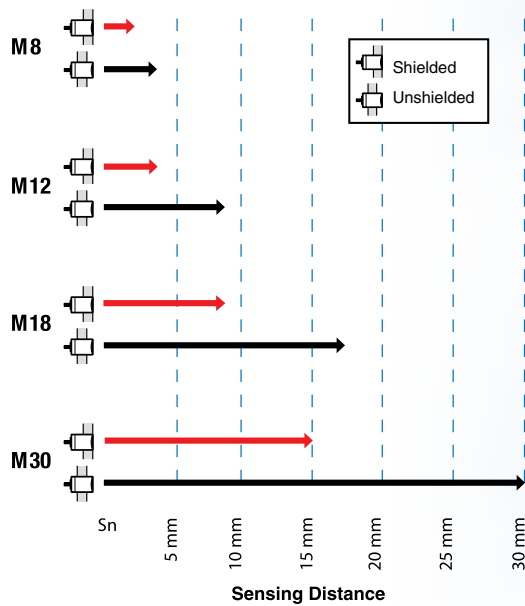

Cylindrical, Brass Housing, DC 2-Wire, DC 3-Wire and AC 2-Wire	E2E
Cylindrical brass housing, DC 3-Wire and antivalent (DC 4-Wire)	E2A
Long Barrel, cylindrical brass housing, DC 2-Wire, DC 3-Wire and AC 2-Wire	E2E2
Long Barrel, cylindrical brass housing, DC 2-Wire	E2A
Short or Long Barrel, cylindrical brass housing, DC 3-Wire	E2B



- Highest water resistance
- Highest electromagnetic noise immunity (e.g. from inverters)
- Antivalent output for cable breakage detection
- Wide connection range

### Special Applications

**Enhanced oil resistance**

**E2E-U**

Tested oil resistance on commonly used lubricants

**Chemical resistant plastic body**

**E2F**

Polyarylate plastic housing

**Detergent resistant**

**E2EH**

Stainless steel housing

**Metal chip immune**

**E2FM**

All stainless steel body resists impacts, abrasive scouring

Miniature housing:

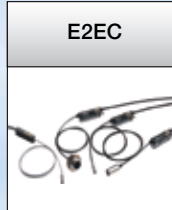

Compact square housing:



Longer distance:



**Special Applications**

**Chemical resistant**



**E2FQ**

Fluoro plastic (PTFE) housing



**Remote amplifier**



**E2C-EDA**

Heat resistant; Small sensing heads to fit tight spaces

**Weld spatter resistant**







**E2EQ**

Rugged fluoro resin coated brass housing

# Selection Table





## Capacitive Sensors

Detect non-magnetic metals, glass, plastic, liquids, wood and leather, including liquids or solids inside non-metallic containers.

Standard cylindrical	Unthreaded cylindrical	Flat rectangular	Liquid level	Chemical resistant
				
<b>E2K-X</b>	<b>E2K-C</b>	<b>E2K-F</b>	<b>E2K-L</b>	<b>E2KQ-X</b>
ABS housing	Adjustable distance; ABS housing	Thin low-profile ABS housing for conveyor rail mounting	Detects clear and foamy liquids, mounts to sight glass and piping	Fluoroplastic resin coating



## Proximity Sensors - Special Application



Inductive sensors that are specially tuned or sized to solve tough detection problems in challenging locations.

Miniature separate amplifier	Aluminum detection	Non-ferrous metals only	Cutting chip resistant
			
<b>E2EC</b>	<b>E2CY</b>	<b>E2EY</b>	<b>E2EZ</b>
For demanding mounting conditions	Separate amplifier with compact head	Aluminum; Copper; Brass	Machine tool applications





# Proximity Sensors

Category	Inductive Proximity	Inductive Proximity	Inductive Proximity
			
Model	E2E	E2B	E2A
Product type	Standard cylindrical	Short or long barrel, standard or extended range cylindrical	Short or long barrel, extended range cylindrical
Maximum Shielded sensing distances	10 mm	15 mm	15 mm
Maximum Unshielded sensing distances	20 mm	30 mm	30 mm
DC supply voltage	12 to 24 VDC	10 to 30 VDC	12 to 24 VDC
AC supply voltage	24 to 240 VAC or 90 to 140 VAC 50/60 Hz	N/A	N/A
Load ratings	100, 200 or 300 mA max.	200 mA max.	100 mA max.
Output types	NPN, PNP, DC 2-Wire or SCR	NPN or PNP	NPN or PNP
Output state	N.O. or N.C.	N.O. or N.C.	N.O. or N.C.
Connections	Pre-wired, connector	Pre-wired, connector	Pre-wired, connector
IP rating	IP67	IP67	IP69K



Category	Inductive Proximity	Inductive Proximity	Inductive Proximity
			
Model	E2EM	E2A3	E2E2
Product type	Standard cylindrical, extended range cylindrical	Standard cylindrical, extra long-distance cylindrical	Long barrel cylindrical
Maximum Shielded sensing distances	15 mm	20 mm	10 mm
Maximum Unshielded sensing distances	30 mm	N/A (Shielded only)	20 mm
DC supply voltage	12 to 24 VDC	12 to 24 VDC	12 to 24 VDC
AC supply voltage	N/A	N/A	24 to 240 VAC or 90 to 140 VAC 50/60 Hz
Load ratings	100 mA and 200 mA max.	200 mA max.	100, 200 or 300 mA max.
Output types	NPN, PNP, or DC 2-wire	NPN or PNP	NPN, PNP, DC 2-Wire or SCR
Output state	N.O. or N.C.	N.O. or N.C.	N.O. or N.C.
Connections	Pre-wired, connector	Pre-wired, connector	Pre-wired, connector
IP rating	IP67	IP67	IP67



## Selection Table

Category	Inductive Proximity	Inductive Proximity	Inductive Proximity
			
Model	E2EC	TL-W	E2Q5
Product type	Subminiature cylindrical with long-distance detection	Flat rectangular proximity sensor	Long distance square proximity sensor
Maximum Shielded sensing distances	4 mm	5 mm	20 mm
Maximum Unshielded sensing distances	N/A (Shielded only)	20 mm	40 mm
DC supply voltage	12 to 24 VDC and 5 to 24 VDC	12 to 24 VDC	10 to 30 VDC
AC supply voltage	N/A	N/A	N/A
Load ratings	100 mA max.	100 mA and 200 mA max.	200 mA max.
Output types	NPN, PNP, or DC 2-Wire	NPN, PNP, or DC 2-wire	NPN or PNP
Output state	N.O. or N.C.	N.O. or N.C.	N.O. or N.O. + N.C.
Connections	Pre-wired	Pre-wired	M12 quick disconnect
IP rating	IP64 and IP67	IP67	IP67 and IP69K



Category	Inductive Proximity	Inductive Proximity	Inductive Proximity
			
Model	E2S	E2F	E2FM
Product type	Super-compact rectangular proximity sensor	Cylindrical proximity sensor with resin case and superb water resistance	Highly durable cylindrical proximity sensor for tough environments
Maximum Shielded sensing distances	N/A	10 mm	10 mm
Maximum Unshielded sensing distances	2.5 mm	N/A	N/A
DC supply voltage	12 to 24 VDC	12 to 24 VDC	12 to 24 VDC
AC supply voltage	N/A	90 to 140 VAC and 24 to 240 VAC	N/A
Load ratings	50 mA max.	100, 200, 300 and 500 mA max.	100 mA and 200 mA max.
Output types	NPN, PNP and DC 2-Wire	NPN, PNP and SCR	NPN, PNP and DC 2-Wire
Output state	N.O. or N.C.	N.O. or N.C.	N.O. or N.C.
Connections	Pre-wired	Pre-wired	Pre-wired, connector
IP rating	IP67	IP68	IP67

# Proximity Sensors

Category	Inductive Proximity	Inductive Proximity	Inductive Proximity
			
Model	E2EH	E2E-U	E2EQ
Product type	High temperature detergent resistant cylindrical proximity sensor	Oil resistant cylindrical	Spatter-resistant fluororesin coated proximity sensor
Maximum Shielded sensing distances	12 mm	10 mm	15 mm
Maximum Unshielded sensing distances	N/A	N/A	N/A
DC supply voltage	12 to 24 VDC	12 to 24 VDC	12 to 24 VDC
AC supply voltage	N/A	N/A	N/A
Load ratings	50 mA and 100 mA max.	100 mA max.	100 mA max.
Output types	NPN, PNP and DC 2-Wire	DC 2-wire	DC 2-Wire
Output state	N.O. or N.C.	N.O. or N.C.	N.O. or N.C.
Connections	Pre-wired, connector	Pre-wired, connector	Pre-wired, connector
IP rating	IP67, IP69K	IP67 and IP67g	IP67

Category	Inductive Proximity	Capacitive Proximity	Inductive Proximity
			
Model	E2KQ-X	E2FQ	E2C-EDA
Product type	Fluororesin coated, chemical resistant capacitive sensor with sensitivity adjuster	Fluororesin coated, chemical resistant Inductive sensor	High precision positioning proximity sensor with separate digital amplifier
Maximum Shielded sensing distances	N/A	10 mm	5 mm
Maximum Unshielded sensing distances	10 mm	N/A	7 mm
DC supply voltage	12 to 24 VDC	12 to 24 VDC	12 to 24 VDC
AC supply voltage	N/A	N/A	N/A
Load ratings	100 mA max.	100, 200 and 300 mA max.	50 mA max.
Output types	NPN	NPN, DC 2-wire and SCR	NPN and PNP
Output state	N.O. or N.C.	N.O.	N.O. or N.C.
Connections	Pre-wired	Pre-wired	Pre-wired, connector
IP rating	IP66	IP67	IP50, IP60, IP67

# Selection Table

Category	Inductive Proximity	Capacitive Proximity	Capacitive Proximity
			
Model	<b>E2K-X</b>	<b>E2K-C</b>	<b>E2K-F</b>
Product type	General purpose threaded cylindrical capacitive sensor	Long-distance cylindrical capacitive sensor with adjustable sensitivity	Flat proximity sensor
Maximum Shielded sensing distances	N/A	N/A	N/A
Maximum Unshielded sensing distances	15 mm	25 mm	10 mm
DC supply voltage	12 to 24 VDC	12 to 24 VDC and 24 to 240 VDC	12 to 24 VDC
AC supply voltage	100 to 220 VAC, 50/60 Hz	100 to 220 VAC, 50/60 Hz and 24 to 240 VAC 50/60 Hz	N/A
Load ratings	200 mA max.	200 mA and 250 mA max.	100 mA max.
Output types	NPN, PNP and SCR	NPN, PNP and SCR	NPN
Output state	N.O. or N.C.	N.O. or N.C.	N.O. or N.C.
Connections	Pre-wired	Pre-wired	Pre-wired
IP rating	IP66	IP66, IP67	IP64, IP66

Category	Capacitive Proximity
	
Model	<b>E2K-L</b>
Product type	Liquid level sensor
Maximum Shielded sensing distances	N/A
Maximum Unshielded sensing distances	1.5 mm
DC supply voltage	12 to 24 VDC
AC supply voltage	N/A
Load ratings	100 mA max.
Output types	NPN
Output state	N.O.
Connections	Pre-wired
IP rating	IP64, IP66

## Standard Cylindrical DC 2-Wire, DC 3-Wire, and AC Proximity Sensors

- DC 2-wire, DC 3-wire, AC/DC 2-wire, and AC 2-wire versions available
- Popular for Automotive, Food/Beverage, and Packaging Industries
- Thick nickel-plated brass (NPB) barrel
- Wrench flats for easy installation
- Solid potted internal circuitry withstands shocks
- IP67 and IP69K rated
- Flush mountable shielded versions
- Built-in circuit protection
- Sensor mounting and protective accessories, see Y92E



## Ordering Information

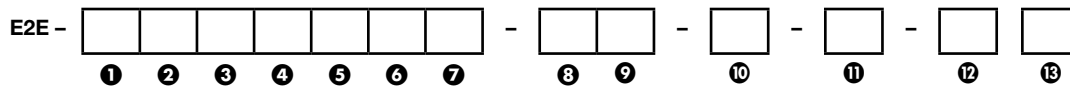

Code	Description
<b>① Appearance</b>	
C	Cylindrical (not threaded)
X	Cylindrical (threaded)
<b>② Sensing Distance</b>	
(number)	Sensing distance (unit: mm)
R	Indication of decimal point Example: R6 = 0.6 mm; 1R5 = 1.5 mm
<b>③ Shielding</b>	
(blank)	Shielded models
M	Unshielded models
<b>④ Power Supply and Output Specifications</b> Whether D models have polarity is defined by ⑩.	
B	DC 3-wire PNP open-collector output
C	DC 3-wire NPN open-collector output
D	DC 2-wire polarity/no polarity
E	DC 3-wire NPN collector load built-in output
F	DC 3-wire PNP collector load built-in output
T	AC/DC 2-wire
Y	AC 2-wire

<b>⑤ Form of Output Switching Element</b>	
1	Normally open (NO)
2	Normally closed (NC)
<b>⑥ Oscillation Frequency Type</b> (Used to prevent mutual interference.)	
(blank)	Standard frequency
5	Different frequency
<b>⑦ Self-diagnosis</b>	
(blank)	No
5	Yes
<b>⑧ Connection Method</b>	
(blank)	Pre-wired
M1	M12-size metal connector
M3	M8-size metal connector

(continued on next page)

**Note:** Models are not available for all combinations of code numbers.

(continued from previous page)

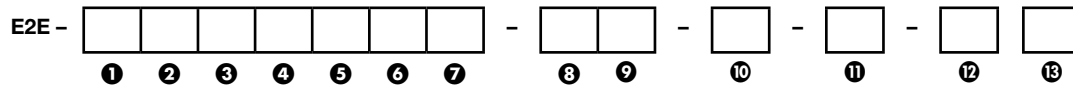

⑨ Connector Specifications	
(blank)	Connector models DC 3-wire and AC 2-wire, DC 2-wire with self diagnosis output, DC 2 wire with old pin arrangement
G	Connector models DC 2-wire with IEC pin arrangement
J	Pre-wired connector models DC 3-wire and AC 2-wire, DC 2-wire with old pin arrangement
GJ	Pre-wired connector models DC 2-wire with IEC pin arrangement
TJ	Pre-wired Smartclick connector models DC 2-wire
TGJ	Pre-wired Smartclick connector models DC 2-wire with IEC pin arrangement
⑩ DC 2-Wire Polarity	
(blank)	Polarity
T	No polarity

⑪ Cable Specifications	
(blank)	Standard PVC cable (oil resistant)
R	Flexible PVC cable (oil resistant)
U	Polyurethane cable (oil resistant and reinforced)
⑫ New Model	
N	New model (Applies only to DC 2-wire pre-wired and shielded models.) This is blank if the cable specification in ⑪ is R or U.
⑬ Cable Length	
(number) M	Cable length (unit: m) (Applicable to pre-wired models and pre-wired connector models. Examples: 2M, 0.3M)

**Note:** Models are not available for all combinations of code numbers.

The purpose of this model number legend is to provide understanding of the meaning of specifications from the model number.

## Standard Environment DC 3-Wire

- Popular applications: Material handling, Conveying, Machine tools
- All-around 360° visible output indicator
- IP67 water resistance
- Laser-etched part numbers that do not wear off
- M8 - M30 sizes, Single or Double sensing distances, Short or Long body



## Ordering Information

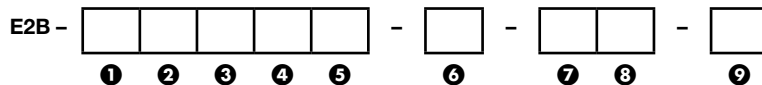

Examples:

E2B-M12LS04-M1-B1

Standard, M12, long barrel, shielded, Sn=4 mm, M12 connector, PNP-NO

E2B-S08KN04-WP-B1 5M

Standard, M8 stainless steel, short barrel, non-shielded, Sn=4 mm, pre-wired PVC cable, PNP-NO, cable length = 5 m

Code	Description
<b>① Housing shape and material</b>	
M	Cylindrical, metric threaded, brass
S	Cylindrical, metric threaded, stainless steel
<b>② Housing Size</b>	
08	8 mm
12	12 mm
18	18 mm
30	30 mm
<b>③ Barrel Length</b>	
K	Standard length
L	Long body
<b>④ Shield</b>	
S	Shielded
N	Non-shielded
<b>⑤ Sensing Distance</b>	
(number)	Sensing distance Example: 02 = 2 mm; 16 = 16 mm

<b>⑥ Type of Connection</b>	
WP	Pre-wired, PVC, dia 4 mm (standard)
M1	M12 connector (4 pin)
MC	M8 connector (3 pin)
<b>⑦ Power Source and Output</b>	
B	DC, 3-wire, PNP open collector
C	DC, 3-wire, NPN open collector
<b>⑧ Operation Mode</b>	
1	Normally open (NO)
2	Normally closed (NC)
<b>⑨ Cable Length</b>	
(blank)	Connector type
(number)	Cable length

**Note:** Models are not available for all combinations of code numbers.

## Increased Sensing Range DC Inductive

- DC 3-Wire, DC 4-Wire (NO+NC)
- Popular in Food/Beverage, Bottling, and Packaging industries
- Extended (double) sensing distance
- IP67 and IP69K for wash down resistance
- Standard or Long body length
- Wide installation and connectivity range through modular concept



## Ordering Information

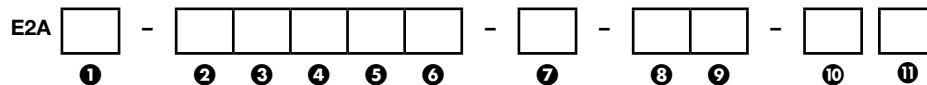

Examples:

E2A-M12LS04-M1-B1

Standard, M12, long barrel, shielded, Sn=4 mm, M12 connector, PNP-NO

E2A-M08KN04-WP-B1 5M

Standard, M8 stainless steel, short barrel, non-shielded, Sn=4 mm, pre-wired PVC cable, PNP-NO, cable length = 5 m

Code	Description
<b>① Sensing Technology</b>	
(blank)	Standard double distance
<b>② Housing shape and material</b>	
M	Cylindrical, metric threaded, brass
S	Cylindrical, metric threaded, stainless steel
<b>③ Housing Size</b>	
08	8 mm
12	12 mm
18	18 mm
30	30 mm
<b>④ Barrel Length</b>	
K	Standard length
L	Long body
<b>⑤ Shield</b>	
S	Shielded
N	Non-shielded
<b>⑥ Sensing Distance</b>	
(number)	Sensing distance Example: 02 = 2 mm; 16 = 16 mm

<b>⑦ Type of Connection</b>	
WP	Pre-wired, PVC, dia 4 mm (standard)
M1	M12 connector (4-pole)
M3	M8 connector (4-pole)
M5	M8 connector (3-pole)
<b>⑧ Power Source and Output</b>	
B	DC, 3-wire, PNP open collector
C	DC, 3-wire, NPN open collector
E	DC, 3-wire, NPN voltage output
F	DC, 3-wire, PNP voltage output
<b>⑨ Operation Mode</b>	
1	Normally open (NO)
2	Normally closed (NC)
<b>⑩ Specials</b> Example: Cable material, oscillating frequency)	
<b>⑪ Cable Length</b>	
(blank)	Connector type
(number)	Cable type

**Note:** Models are not available for all combinations of code numbers.



## Extended Range, DC 2-Wire Standard Cylindrical Sensors

- Nickel-Plated Brass (NPB) barrel
- Wrench flats for easy installation
- Solid potted internal circuitry withstands shocks
- IP67 rated, 1200 psi water washdown
- Built-in circuit protection
- Normally Open (NO) circuit type stocked; Normally Closed (NC) available



## DC 2-Wire Sensors, Pre-Wired with 2 m Cable

Size	Sensing Distance (mm)	Shielded	Circuit Type	Response Frequency	Body Material	Thread Length (overall length) mm	Model
M12	4.0	Yes	NO	1 kHz	NPB	33 (38)	E2EM-X4X1
M18	8.0			500 Hz			E2EM-X8X1
	16.0	No		400 Hz		50 (65)	
M30	15.0	Yes		250 Hz		43 (48)	E2EM-X15X1
	30.0	No	100 Hz	50 (70)		E2EM-X30MX1	

## DC 2-Wire with M12 Micro-Change® Connectors

NPN Normally Open (C1-M1)

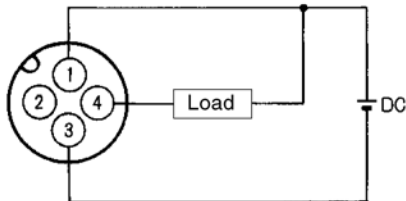

PNP Normally Open (B1-M1)

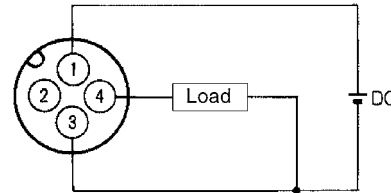

Size	Sensing Distance (mm)	Shielded	Circuit Type	Response Frequency	Body Material	Thread Length (overall length) mm	Model
M8	2.0	Yes	NPN-NO	1.5 kHz	NPB	30 (43)	E2EM-X2C1-M1
			PNP-NO				E2EM-X2B1-M1
M12	4.0		NPN-NO	500 Hz		33 (48)	E2EM-X4C1-M1
			PNP-NO				E2EM-X4B1-M1
M18	8.0		NPN-NO	300 Hz		38 (53)	E2EM-X8C1-M1
			PNP-NO				E2EM-X8B1-M1
M30	15.0		NPN-NO	100 Hz		38 (53)	E2EM-X15C1-M1
			PNP-NO				E2EM-X15B1-M1

## Triple Distance Inductive Sensor in Cylindrical Brass Housing

The E2A3 family features an optimized sensing performance to achieve triple sensing distance for flush mounting requirements.



- Triple distance for enhanced sensor protection from mechanical damage
- IP67 and IP69K

## DC 3-Wire Sensors, Pre-Wired

(For different cable materials and lengths, special housing length or special connectors, please refer to complete datasheet)

Size		Sensing Distance	Thread Length (overall length)	Output Type	Model (for pre-wired types with 2 m cable length)	
					Operation Mode NO	Operation Mode NC
M8	■	3.0 mm	27 (40) mm	PNP	E2A3-S08KS03-WP-B1 2M	E2A3-S08KS03-WP-B2 2M
				NPN	E2A3-S08KS03-WP-C1 2M	E2A3-S08KS03-WP-C2 2M
M12	■	6.0 mm	34 (50) mm	PNP	E2A3-M12KS06-WP-B1 2M	E2A3-M12KS06-WP-B2 2M
				NPN	E2A3-M12KS06-WP-C1 2M	E2A3-M12KS06-WP-C2 2M
M18	■	11.0 mm	39 (60) mm	PNP	E2A3-M18KS11-WP-B1 2M	E2A3-M18KS11-WP-B2 2M
				NPN	E2A3-M18KS11-WP-C1 2M	E2A3-M18KS11-WP-C2 2M
M30	■	20.0 mm	44 (65) mm	PNP	E2A3-M30KS20-WP-B1 2M	E2A3-M30KS20-WP-B2 2M
				NPN	E2A3-M30KS20-WP-C1 2M	E2A3-M30KS20-WP-C2 2M

## DC 3-Wire Sensors, Connector Versions (M12)

Size		Sensing Distance	Connection	Thread Length (overall length)	Output Type	Model (for M12 connector types)	
						Operation Mode NO	Operation Mode NC
M8	■	3.0 mm	M12 Connector	27 (44) mm	PNP	E2A3-S08KS03-M1-B1	E2A3-S08KS03-M1-B2
					NPN	E2A3-S08KS03-M1-C1	E2A3-S08KS03-M1-C2
M12	■	6.0 mm		34 (49) mm	PNP	E2A3-M12KS06-M1-B1	E2A3-M12KS06-M1-B2
					NPN	E2A3-M12KS06-M1-C1	E2A3-M12KS06-M1-C2
M18	■	11.0 mm		39 (54) mm	PNP	E2A3-M18KS11-M1-B1	E2A3-M18KS11-M1-B2
					NPN	E2A3-M18KS11-M1-C1	E2A3-M18KS11-M1-C2
M30	■	20.0 mm		44 (59) mm	PNP	E2A3-M30KS20-M1-B1	E2A3-M30KS20-M1-B2
					NPN	E2A3-M30KS20-M1-C1	E2A3-M30KS20-M1-C2

## Long-Barrel DC 2-Wire Proximity Sensors Reduce Wiring to Control Devices

- Nickel-plated brass (NPB) barrel
- Wrench flats for easy installation
- Solid potted internal circuitry withstands shocks
- IP67 rated, 1200 psi water washdown
- High visibility indicator
- Flush mountable shielded versions
- Built-in circuit protection
- Normally Open (NO) circuit type stocked; Normally Closed (NC) available
- Sensor mounting and protective accessories, see Y92E



L

## DC 2-Wire Sensors, Pre-Wired with 2 m Cable

Size	Sensing Distance (mm)	Shielded	Circuit Type	Response Frequency	Body Material	Thread Length (overall length) mm	Model
M12	3.0	Yes	NO	1000 Hz	NPB	55 (60)	E2E2-X3D1
			NC				E2E2-X3D2
	8.0	No	NO	800 Hz		48 (60)	E2E2-X8MD1
			NC				E2E2-X8MD2
M18	7.0	Yes	NO	500 Hz	NPB	60 (65)	E2E2-X7D1
			NC				E2E2-X7D2
	14.0	No	NO	400 Hz		50 (65)	E2E2-X14MD1
			NC				E2E2-X14MD2
M30	10.0	Yes	NO	100 Hz	NPB	65 (70)	E2E2-X10D1
			NC				E2E2-X10D2
	20.0	No	NO	100 Hz		52 (70)	E2E2-X20MD1
			NC				E2E2-X20MD2

## Long-Barrel DC 3-Wire Proximity Sensors Built for Rugged Duty

- Nickel-plated brass (NPB) barrel
- Wrench flats for easy installation
- Solid potted internal circuitry withstands shocks
- IP67 rated, 1200 psi water washdown
- High visibility indicator
- Voltage output eliminates the need for pull up/down resistors (standard models)
- Flush mountable shielded versions
- Unshielded models offer longest sensing distances
- Built-in circuit and polarity protection
- Normally Open (NO) models stocked; Normally Closed (NC) available
- Sensor mounting and protective accessories, see Y92E



## DC 3-Wire Sensors, Pre-Wired with 2 m Cable

Size	Sensing Distance (mm)	Shielded	Circuit Type	Response Frequency	Body Material	Thread Length (overall length) mm	Model
M12	2.0	Yes	NPN-NO	1.5 kHz	NPB	55 (60)	E2E2-X2C1
			PNP-NO				E2E2-X2B1
	5.0	No	NPN-NO	400 Hz		48 (60)	E2E2-X5MC1
			PNP-NO				E2E2-X5MB1
M18	5.0	Yes	NPN-NO	600 Hz	NPB	60 (65)	E2E2-X5C1
			PNP-NO				E2E2-X5B1
	10.0	No	NPN-NO	200 Hz		50 (65)	E2E2-X10MC1
			PNP-NO				E2E2-X10MB1
M30	10.0	Yes	NPN-NO	400 Hz	NPB	65 (70)	E2E2-X10C1
			PNP-NO				E2E2-X10B1
	18.0	No	NPN-NO	100 Hz		52 (70)	E2E2-X18MC1
			PNP-NO				E2E2-X18MB1

## DC 3-Wire Sensors with Built-in M12 Micro-Change® Connectors

NPN Normally Open (C1-M1)

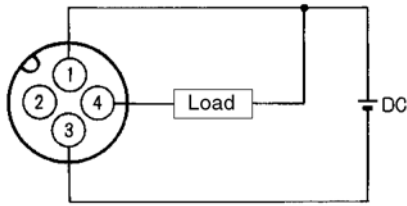

Note: Terminal 2 is not used

PNP Normally Open (B1-M1)

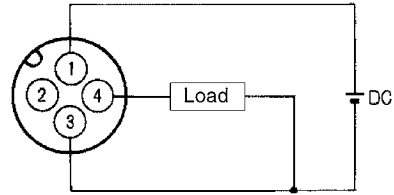

Note: Terminal 2 is not used

Size	Sensing Distance (mm)	Shielded	Circuit Type	Response Frequency	Body Material	Thread Length (overall length) mm	Model
M12	2.0	Yes	NPN-NO	1.5 kHz	NPB	55 (70)	E2E2-X2C1-M1
			PNP-NO				E2E2-X2B1-M1
	5.0	No	NPN-NO	400 Hz		48 (70)	E2E2-X5MC1-M1
			PNP-NO				E2E2-X5MB1-M1
M18	5.0	Yes	NPN-NO	600 Hz		60 (75)	E2E2-X5C1-M1
			PNP-NO				E2E2-X5B1-M1
	10.0	No	NPN-NO	200 Hz		50 (75)	E2E2-X10MC1-M1
			PNP-NO				E2E2-X10MB1-M1
M30	10.0	Yes	NPN-NO	400 Hz	65 (80)	E2E2-X10C1-M1	
			PNP-NO			E2E2-X10B1-M1	
	18.0	No	NPN-NO	100 Hz	52 (80)	E2E2-X18MC1-M1	
			PNP-NO			E2E2-X18MB1-M1	

## Long-Barrel AC 2-Wire Proximity Sensors Built for Rugged Duty

- Nickel-plated brass (NPB) barrel
- Wrench flats for easy installation
- Solid potted internal circuitry withstands shocks
- IP67 rated, 1200 psi water washdown
- High visibility indicator
- Flush mountable shielded versions
- Normally Open (NO) models stocked; Normally Closed (NC) available
- Sensor mounting and protective accessories, see Y92E



## AC 2-Wire Sensors, Pre-Wired with 2 m Cable

Size	Sensing Distance (mm)	Shielded	Circuit Type	Response Frequency	Body Material	Thread Length (overall length) mm	Model
M12	2.0	Yes	NO	25 Hz	NPB	55 (60)	E2E2-X2Y1-US
	5.0	No				48 (60)	E2E2-X5MY1-US
M18		Yes				60 (65)	E2E2-X5Y1-US
	10.0	No				50 (65)	E2E2-X10MY1-US
M30	18.0	Yes				65 (70)	E2E2-X10Y1-US
		No				52 (70)	E2E2-X18MY1-US

## AC 2-Wire Sensors with M12, 3-Pin Dual Key-Way Micro-Change® Connectors

Normally Open

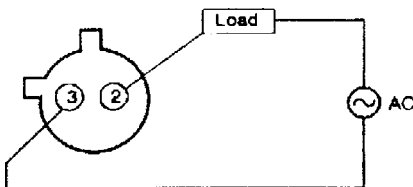

Size	Sensing Distance (mm)	Shielded	Circuit Type	Response Frequency	Body Material	Thread Length (overall length) mm	Model
M12	2.0	Yes	NO	25 Hz	NPB	55 (70)	E2E2-X2Y1-M4
	5.0	No				48 (70)	E2E2-X5MY1-M4
M18		Yes				60 (75)	E2E2-X5Y1-M4
	10.0	No				50 (75)	E2E2-X10MY1-M4
M30	18.0	Yes				65 (80)	E2E2-X10Y1-M4
		No				52 (80)	E2E2-X18MY1-M4

## Small Diameter, DC 3-Wire Proximity Sensor in Cylindrical Metal Housing

The E2E Small Diameter line with housing sizes from 3 mm dia to 5.4 mm dia is part of the E2E family and is the ideal solution where space is crucial. The metal housing provides high mechanical protection.

- Miniature housing sizes from 3 mm dia to 6.5 mm dia
- Stainless steel or brass housing
- 5 kHz switching frequency
- Mounting blocks, brackets and protective stainless steel tubes available



## Ordering Information

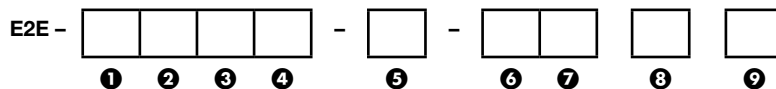

Code	Description
<b>① Case Material and Shape</b>	
C	SUS, cylindrical
S	SUS, threaded
<b>② Size</b>	
03	Outer diameter 3 mm
04	Outer diameter 4 mm
05	Threaded: Outer diameter 5 mm Cylindrical: Outer diameter 5.4 mm
06	Outer diameter 6.5 mm
<b>③ Shielding</b>	
S	Shielded models
N	Unshielded models
<b>④ Sensing Distance</b>	
(number)	R8 = 0.8 mm, 01: 1mm, 12 = 1.2 mm, , 02 = 2 mm, 03 = 3 mm, 04 = 4 mm
<b>⑤ Connecting Method</b>	
WC	PVC pre-wired model
MC	M8 connector, 3-pin
CJ	M8 pre-wired connector, 3-pin

<b>⑥ Output Specifications</b>	
B	DC 3-wire PNP open-collector output
C	DC 3-wire NPN open-collector output
<b>⑦ Operation Mode</b>	
1	Normally open (NO)
2	Normally closed (NC)
<b>⑧ Cable Specifications</b>	
Blank	Standard PVC Cable
R	Robot (bending-resistant) PVC cable
<b>⑨ Cable Length</b>	
Blank	Connector Models
Number M	Cable length (Unit: m) (Applicable to Pre-wired Models 2M/5M and Pre-wired Connector Models 0.3M)

**Note:** Models are not available for all combinations of code numbers.

The purpose of this model number legend is to provide understanding of the meaning of specifications from the model number.

## Subminiature Sensor with In-line Amplifier Offers Great Mounting Flexibility

- Small nickel-plated brass (NPB) sensing heads on 0.4 m cable fit space-confined installations
- Shielded sensing head allows the sensor to be flush mounted in metal
- Easy operation monitoring with LED indicator on the amplifier unit
- Robotic cable on DC 2-wire models withstands repeated flexing on robots and reciprocating machinery
- DC 2-wire models have cylindrical amplifiers; DC 3-wire rectangular amplifiers allow side-by-side mounting
- Normally Open (NO) circuit type stocked; Normally Closed (NC) available
- Rated IP67 (2-wire); IP64 (3-wire)



## DC 2-Wire Sensors

Size	Sensing Distance (mm)	Shielded	Circuit Type	Response Frequency	Body Material	Thread Length (overall length) mm	Model
3 mm dia.	0.8	Yes	NO	1.5 kHz	NPB	0 (12)	E2EC-CR8D1
			NC				E2EC-CR8D2
5.4 mm dia.	1.5		NO	1 kHz		0 (18)	E2EC-C1R5D1
			NC				E2EC-C1R5D2
8 mm dia.	3		NO	1 kHz		18 (23.6)	E2EC-C3D1
			NC				E2EC-C3D2
M12	4		NO	1 kHz		18 (23.6)	E2EC-X4D1
			NC				E2EC-X4D2

## DC 3-Wire Sensors

Size	Sensing Distance (mm)	Shielded	Circuit Type	Response Frequency	Body Material	Thread Length (overall length) mm	Model
3 mm dia.	0.5	Yes	NPN-NO	1 kHz	NPB	0 (12)	E2EC-CR5C1
8 mm dia.	2.5					0 (18)	E2EC-C2R5C1

## Accessories

Description	Model	
Mounting brackets	Fits 5.4 mm dia. E2EC-C1R5D sensors, SUS304 strap	Y92E-F5R4
	Fits M12 size E2EC-X4D□ sensors	Y92E-B12



## Subminiature, Flat-Pack DC Sensor Fits Tight Spaces

- Rated IP67 for water washdown
- Space-saving mounting area, as small as 10 x 27 mm (0.39 x 1.06 in), is ideal for conveyor wall mounting
- Mounts directly onto metal base or rail
- Rugged die-cast metal or heat-resistant ABS plastic housing
- Pre-wired with 2 m (6.56 ft.) length cable
- Built-in circuit protection
- DC 2-wire and DC 3-wire models



## DC 2-Wire Flat-Pack Inductive Sensors

Sensing distance (mm)	Shielded	Circuit Type	Response Frequency	Body material	Dimensions	Model
5	NO	NPN-NO	500 Hz	ABS	30.5 x 18 x 10	TL-W5MD1
		NON-NC				TL-W5MD2

## DC 3-Wire Flat-Pack Inductive Sensors

Sensing Distance (mm)	Shielded	Circuit Type	Response Frequency	Body Material	Dimensions	Model
1.5	No	NPN-NO	1 kHz	ABS	25 x 8 x 5.5	TL-W1R5MC1*
3			600 Hz		27 x 10 x 6	TL-W3MC1*
		NPN-NC	TL-W3MC2*			
5	Yes	NPN-NO	300 Hz	Die cast aluminum	50 x 24.9 x 10	TL-W5E1
		NPN-NC				TL-W5E2
		NPN-NO				TL-W5F1
		NPN-NC				TL-W5F2
20	No	NPN-NO	40 Hz	ABS	53 x 40 x 23	TL-W20ME1
		NPN-NC				TL-W20MF1

\* Model includes mounting bracket.

## Long Distance Inductive Sensor in Short Plastic Body

- M12 Plug-in connection
- Integrated short circuit and reverse polarity protection
- Active face positioning:  
Y-axis 15°, X-axis 90° increments



### DC Models

Sensing Distance (mm)	Connection	Active Face	Model		
			Type	NO	NO+NC
20 mm shielded	Plug-in Connector	Changeable	NPN	E2Q5-N20E1-M1	E2Q5-N20E3-M1
			PNP	E2Q5-N20F1-M1	E2Q5-N20F3-M1
40 mm non-shielded			NPN	E2Q5-N40ME1-M1	E2Q5-N40ME3-M1
			PNP	E2Q5-N40MF1-M1	E2Q5-N40MF3-M1

## World's Smallest Square Sensor with Built-In Amplifier

- 5.5 x 5.5 mm type allows smaller, space-saving machines and devices
- High response frequency (1 kHz) for fast machine processes
- Long sensing distance: (E2S-91, 1.6 mm) (E2S-92, 2.5 mm)
- Front and end sensing face versions match mounting needs
- DC 2-wire and DC 3-wire models
- Pre-wired with 1 m cable
- Rated IP67 for water washdown



## Threaded, Cylindrical Sensor Detects Metallic and Non-Metallic Objects

- Non-contact detection of metallic and non-metallic targets including water, oil, glass, plastic and wood
- Detects level inside non-metallic containers
- Built-in amplifier switches loads up to 200 mA
- LED indicator and fixed sensitivity for simple installation
- Built-in circuit protection
- Heat-resistant ABS plastic sensor rated IP66



- Normally Open (NO) and Normally Closed (NC) available
- CE (all models), UL, CSA (AC models)
- Sensor mounting and protective accessories, see Y92E

### DC 3-Wire Models

Size	Sensing Distance (mm)	Shielded	Circuit Type	Response Frequency	Body Material	Thread Length (overall length) mm	Model			
M12	4.0	NO	NPN-NO	100 Hz	ABS	40 (80)	E2K-X4ME1			
			NPN-NC				E2K-X4ME2			
			PNP-NO				E2K-X4MF1			
			PNP-NC				E2K-X4MF2			
M18	8.0		NPN-NO	100 Hz			ABS	40 (80)	E2K-X8ME1	
			NPN-NC						E2K-X8ME2	
			PNP-NO						E2K-X8MF1	
			PNP-NC						E2K-X8MF2	
M30	15.0		NPN-NO	100 Hz		ABS			50 (80)	E2K-X15ME1
			NPN-NC							E2K-X15ME2
			PNP-NO							E2K-X15MF1
			PNP-NC							E2K-X15MF2

### AC 2-Wire Models

Size	Sensing Distance (mm)	Shielded	Circuit Type	Response Frequency	Body Material	Thread Length (overall length) mm	Model		
M12	4.0	NO	SCR-NO	10 Hz	ABS	40 (80)	E2K-X4MY1		
			SCR-NC				E2K-X4MY2		
M18	8.0		SCR-NO	10 Hz			ABS	40 (80)	E2K-X8MY1
			SCR-NC						E2K-X8MY2
M30	15.0		SCR-NO	10 Hz		ABS		50 (80)	E2K-X15MY1
			SCR-NC						E2K-X15MY2

## Cylindrical Sensor Offers Adjustable Detecting Distance

- Non-contact detection of metallic and non-metallic targets including water, oil, glass, plastic and wood
- Detects level inside non-metallic containers
- Settable detection distance from 3 to 25 mm with multi-turn adjuster
- Reliably detects foamy liquids in sight glass applications
- Built-in amplifier switches up to 200 mA
- Mounting bracket included
- AC 2-wire and DC 3-wire models available
- Heat-resistant ABS plastic sensor rated IP66



- Normally Open (NO) and Normally Closed (NC) available
- CE (all models), UL, CSA (AC models)

## DC 3-Wire Sensors

Size (dia.)	Sensing Distance (mm)	Shielded	Circuit Type	Response Frequency	Body Material	Thread Length (overall length) mm	Model
34 mm	3 to 25	No	NPN-NO	70 Hz	ABS	0 (89)	E2K-C25ME1
			NPN-NC				E2K-C25ME2
			PNP-NO				E2K-C25MF1
			PNP-NC				E2K-C25MF2

## AC 2-Wire Sensors

Size (dia.)	Sensing Distance (mm)	Shielded	Circuit Type	Response Frequency	Body Material	Thread Length (overall length) mm	Model
34 mm	3 to 25	No	SCR-NO	10 Hz	ABS	0 (89)	E2K-C25MY1
			SCR-NC				E2K-C25MY2

## Accessories

Barrel size	Description	Model
M30 (34 mm)	Sight Glass Mount for M30 (34 mm) Barrel Proximity Sensor	Y92E-SGM34

## Thin Rectangular Plastic DC 3-Wire Sensor Fits Tight Spaces

- Non-contact detection of metallic and non-metallic targets including water, oil, glass, plastic and wood
- Detects level inside non-metallic containers
- Thin, 10 mm (0.39 inch) body is ideal for conveyor wall mounting
- Unshielded sensor has LED indicator and fixed sensitivity for simple installation
- Built-in amplifier provides NPN switching of loads to 100 mA



- Heat-resistant ABS plastic body rated IP66

## Flat-Pack Capacitive Sensors

Sensing Distance (mm)	Shielded	Circuit Type	Response Frequency	Body Material	Dimensions (H x W x D) mm	Model
10	No	NPN-NO	100 Hz	ABS	20.5 x 50 x 10.1	E2K-F10MC1
		NPN-NC				E2K-F10MC2
4-10		NPN-NO				E2K-F10MC1-A
		NPN-NC				E2K-F10MC2-A

## Capacitive Liquid Level Sensor

- Mounts directly to sight glass and bypass pipes
- Sensors unaffected by liquid color
- Fits a wide range of pipe diameters: 8 to 11 mm or 12 to 26 mm
- Built-in amplifier with indicator and sensitivity adjuster
- Sensing heads rated IP66



## Watertight and Chemical-Resistant Short Barrel, Plastic Body Sensors

- IP68 watertight construction
- Polyarylate plastic housing offers good chemical resistance to acids and solvents
- Operation indicator on all models
- Short-circuit protection available on all DC and some AC models
- CE all models; UL and CSA (M18, M30 AC 2-wire)



- Sensor mounting and protective accessories, see Y92E

## DC 3-Wire Models

Size	Sensing Distance (mm)	Shielded	Circuit Type	Response Frequency	Body Material	Thread Length (overall length) mm	Model
M8	1.5	Yes	NPN-NO	2 kHz	Polyarylate	20 (30)	E2F-X1R5E1
			NPN-NC				E2F-X1R5E2
			PNP-NO				E2F-X1R5F1
			PNP-NC				E2F-X1R5F2
M12	2.0	Yes	NPN-NO	1.5 kHz	Polyarylate	24 (38)	E2F-X2E1
			NPN-NC				E2F-X2E2
			PNP-NO				E2F-X2F1
			PNP-NC				E2F-X2F2
M18	5.0	Yes	NPN-NO	600 Hz	Polyarylate	29 (47)	E2F-X5E1
			NPN-NC				E2F-X5E2
			PNP-NO				E2F-X5F1
			PNP-NC				E2F-X5F2
M30	10.0	Yes	NPN-NO	400 Hz	Polyarylate	38 (57)	E2F-X10E1
			NPN-NC				E2F-X10E2
			PNP-NO				E2F-X10F1
			PNP-NC				E2F-X10F2

## AC 2-Wire Sensors

### Without Short-Circuit Protection

Size	Sensing Distance (mm)	Shielded	Circuit Type	Response Frequency	Body Material	Thread Length (overall length) mm	Model
M8	1.5	Yes	SCR-NO	25 Hz	Polyarylate	29 (40)	E2F-X1R5Y1
			SCR-NC				E2F-X1R5Y2
M12	2.0	Yes	SCR-NO	25 kHz	Polyarylate	29 (43)	E2F-X2Y1
			SCR-NC				E2F-X2Y2
M18	5.0	Yes	SCR-NO	25 Hz	Polyarylate	29 (47)	E2F-X5Y1-US
			SCR-NC				E2F-X5Y2-US
M30	10.0	Yes	SCR-NO	25 Hz	Polyarylate	38 (57)	E2F-X10Y1-US
			SCR-NC				E2F-X10Y2-US

## All-Stainless Inductive Sensor Resists Abrasion and Chemicals

- One-piece 303 stainless steel face/barrel construction resists damage caused by work piece contact, scouring abrasion, and harsh chemicals
- Up to 0.8 mm thick sensing face for superior mechanical durability, wear resistance
- Operation not influenced by accumulation of aluminum or iron cutting chips and weld slag
- 20% longer sensing range (10 mm) with M30 models versus the CENELEC standard 8 mm
- Flush mountable in ferrous materials to protect sensor from side impact damage
- Thick insulation protects pig-tail lead for increased endurance in harsh environments
- IP67 enclosure rating



## DC 3-Wire Sensors, Pre-Wired with 2 m Cable

Size	Sensing Distance (mm)	Shielded	Output Type	Response Frequency	Thread Length (overall length) mm	Model
M8	1.5	Yes	PNP-NO	200 Hz	25 (49)	E2FM-X1R5B1
			NPN-NO			E2FM-X1R5C1
M12	2.0		PNP-NO	100 Hz	33 (53)	E2FM-X2B1
			NPN-NO			E2FM-X2C1
M18	5.0		PNP-NO	50 Hz	36 (56)	E2FM-X5B1
			NPN-NO			E2FM-X5C1
M30	10.0		PNP-NO	50 Hz	43 (63.5)	E2FM-X10B1
			NPN-NO			E2FM-X10C1

## DC 3-Wire Sensors, Built-in M12 Connector

Size	Sensing Distance (mm)	Shielded	Circuit Type	Response Frequency	Thread Length (overall length) mm	Model
M8	1.5	Yes	PNP-NO	200 Hz	25 (53.5)	E2FM-X1R5B1-M1
			NPN-NO			E2FM-X1R5C1-M1
M12	2.0		PNP-NO	100 Hz	33 (53)	E2FM-X2B1-M1
			NPN-NO			E2FM-X2C1-M1
M18	5.0		PNP-NO	50 Hz	36 (56)	E2FM-X5B1-M1
			NPN-NO			E2FM-X5C1-M1
M30	10.0		PNP-NO	50 Hz	43 (63.5)	E2FM-X10B1-M1
			NPN-NO			E2FM-X10C1-M1

## DC 2-Wire Sensors, Pre-Wired with 2 m Cable

Size	Sensing Distance (mm)	Shielded	Circuit Type	Response Frequency	Thread Length (overall length) mm	Model	
						Standard	with Fluororesin Coating
M8	1.5	Yes	NO, polarity	200 Hz	25 (49)	E2FM-X1R5D1	E2FM-QX1R5D1
M12	2.0			100 Hz	33 (53)	E2FM-X2D1	E2FM-QX2D1
M18	5.0		NO, polarity	36 (56)	E2FM-X5D1	E2FM-QX5D1	
M30	10.0		NO, polarity	50 Hz	43 (63.5)	E2FM-X10D1	E2FM-QX10D1



E2FM extra strong sensing face



No interference by small metal chips on sensing surface



Cable resistant to welding spatter





## Heat and Detergent Resistant Inductive Sensor in Cylindrical Stainless Steel Housing

The heat and detergent resistant inductive sensors allow reliable metal object or machine part detection in demanding environments such as food processing.





- Temperature resistant up to 120°C
- SUS316L housing with heat resistant plastic sensing face
- IP69K for highest water resistance
- ECOLAB tested and certified detergent resistance

### DC 3-Wire and DC 2-Wire Sensors, Pre-Wired

Size		Sensing Distance	Output Type	Model (for pre-wired types with 2 m cable length)	
				Operation Mode NO	Operation Mode NC
M12		3 mm	PNP	E2EH-X3B1 2M	E2EH-X3B2 2M
			NPN	E2EH-X3C1 2M	E2EH-X3C2 2M
			DC 2-wire	E2EH-X3D1 2M	E2EH-X3D2 2M
M18		7 mm	PNP	E2EH-X7B1 2M	E2EH-X7B2 2M
			NPN	E2EH-X7C1 2M	E2EH-X7C2 2M
			DC 2-wire	E2EH-X7D1 2M	E2EH-X7D2 2M
M30		12 mm	PNP	E2EH-X12B1 2M	E2EH-X12B2 2M
			NPN	E2EH-X12C1 2M	E2EH-X12C2 2M
			DC 2-wire	E2EH-X12D1 2M	E2EH-X12D2 2M

### DC 3-Wire and DC 2-Wire Sensors, Connector versions (M12)

Size		Sensing Distance	Output Type	Model (for pre-wired types with 2 m cable length)	
				Operation Mode NO	Operation Mode NC
M12		3 mm	PNP	E2EH-X3B1-M1	E2EH-X3B2-M1
			NPN	E2EH-X3C1-M1	E2EH-X3C2-M1
			DC 2-wire	E2EH-X3D1-M1G	E2EH-X3D2-M1G
M18		7 mm	PNP	E2EH-X7B1-M1	E2EH-X7B2-M1
			NPN	E2EH-X7C1-M1	E2EH-X7C2-M1
			DC 2-wire	E2EH-X7D1-M1G	E2EH-X7D2-M1G
M30		12 mm	PNP	E2EH-X12B1-M1	E2EH-X12B2-M1
			NPN	E2EH-X12C1-M1	E2EH-X12C2-M1
			DC 2-wire	E2EH-X12D1-M1G	E2EH-X12D2-M1G

# E2E-U DC 2-Wire Proximity Sensors

Quick Link  
A285  
omron247.com

## Oil Resistant Inductive Sensor in Cylindrical Brass Housing

Tested oil resistance on commonly used oils in the automotive industry for reliable long-life operation in automotive assembly lines.

- Oil resistant PUR cable
- M8, M12, M18 and M30 standard sizes
- IP67 (water and oil resistant)



### DC 2-wire, Pre-Wired and Pre-Wired with M12

Size		Sensing Distance	Model (for pre-wired types with 2 m cable length)		Model (for pre-wired types with 30 cm cable length and M12 connector)	
			Operation Mode NO	Operation Mode NC	Operation Mode NO	Operation Mode NC
M8	■	2 mm	E2E-X2D1-U	E2E-X2D2-U	E2E-X2D1-M1TGJ-U 0.3M	E2E-X2D2-M1TGJ-U 0.3M
M12		3 mm	E2E-X3D1-U	E2E-X3D2-U	E2E-X3D1-M1TGJ-U 0.3M	E2E-X3D2-M1TGJ-U 0.3M
M18		7 mm	E2E-X7D1-U	E2E-X7D2-U	E2E-X7D1-M1TGJ-U 0.3M	E2E-X7D2-M1TGJ-U 0.3M
M30		10 mm	E2E-X10D1-U	E2E-X10D2-U	E2E-X10D1-M1TGJ-U 0.3M	E2E-X10D2-M1TGJ-U 0.3M

# E2EQ DC 2-Wire Proximity Sensors

Quick Link  
A245  
omron247.com

## Weld-Spatter Resistant Sensors

- Rugged fluoroplastic-coated brass barrel withstands high tightening torque
- Fluoroplastic resin face prevents weld slag build-up on sensor
- Stability and operation indicators standard



### Pre-Wired with 2 m Cable

Size	Sensing Distance (mm)	Shielded	Output Type	Response Frequency	Body Material	Thread Length (overall length) mm	Model
M12	4.0	Yes	NO	1.0 kHz	Fluoroplastic resin coated brass	33 (38)	E2EQ-X4X1
M18	8.0			500 Hz		38 (43)	E2EQ-X8X1
M30	15.0			250 Hz		43 (48)	E2EQ-X15X1

### M12 Connector on 300 mm Pigtail Lead

Size	Sensing Distance (mm)	Shielded	Output Type	Response Frequency	Body Material	Thread Length (overall length) mm	Model
M12	4.0	Yes	NO	1.0 kHz	Fluoroplastic resin coated brass	33 (38)	E2EQ-X4X1-M1J
M18	8.0			500 Hz		38 (43)	E2EQ-X8X1-M1J
M30	15.0			250 Hz		43 (48)	E2EQ-X15X1-M1J

## Chemical Resistant Capacitive Sensor

- Complete fluoroplastic resin coating for superior chemical and oil resistance
- Detect ferrous and non-ferrous metals as well as other materials
- Adjustable sensitivity from 6 to 10 mm
- Built-in indicator located on cable connection face
- Rated IP66



# E2FQ Proximity Sensors

## Chemical Resistant Inductive Sensor in Cylindrical PTFE Housing

The E2FQ features a full-body fluoroplastic housing for chemical resistance (e.g. against cleaning agents used in the semiconductor industry).

- Full body fluoroplastic housing for chemical resistance
- DC 2-wire and DC 3-wire models



### DC 2-Wire, Pre-Wired

Size		Sensing Distance	Output Type	Model (for pre-wired types with 2 m cable length)
				Operation Mode NO
M12	■	2 mm	DC 2-wire with polarity	E2FQ-X2D1
M18		5 mm		E2FQ-X5D1
M30		10 mm		E2FQ-X10D1

### DC 3-Wire, Pre-Wired

Size		Sensing Distance	Output Type	Model (for pre-wired types with 2 m cable length)
				Operation Mode NO
M12	■	2 mm	PNP	E2FQ-X2F1
			NPN	E2FQ-X2E1
M18	■	5 mm	PNP	E2FQ-X5F1
			NPN	E2FQ-X5E1
M30	■	10 mm	PNP	E2FQ-X10F1
			NPN	E2FQ-X10E1





## High Precision Positioning Inductive Proximity Sensor with Separate Amplifier

The separate amplifier inductive sensor family E2C-EDA offers high precision distance positioning and detection. The teach-in function allows simple installation, and with the window function (2 outputs) production tolerance checks can easily be set up and modified.

- Typically several hundred  $\mu\text{m}$  detection precision
- Precision distance teaching
- Window function (2 outputs) for production tolerance checks



### Sensor Heads

Appearance				Sensing Distance	Repeat Accuracy	Model
	3 dia. x 18			0.6 mm	1 $\mu\text{m}$	E2C-EDR6-F
	5.4 dia. x 18			1 mm	1 $\mu\text{m}$	E2C-ED01 <sup>1</sup>
	8 dia. x 22			2 mm	2 $\mu\text{m}$	E2C-ED02 <sup>1</sup>
Screw	M10 x 22			2 mm	2 $\mu\text{m}$	E2C-EM02 <sup>1</sup>
Flat	30 x 14 x 4.8			5 mm	2 $\mu\text{m}$	E2C-EV05 <sup>1</sup>
Screw	M18 x 6.3			7 mm	5 $\mu\text{m}$	E2C-EM07M <sup>1</sup>
Screw (heat resistant)	M12 x 22	2 mm	2 $\mu\text{m}$	E2C-EM02H		

<sup>1</sup> For models with cut-to-length cables add '-F' for example E2C-ED01-F  
 For models with protective stainless steel spiral tubes add '-S' for example E2C-ED01-S

### Amplifier Units with Cables

Item	Sensing Distance	Model	
		NPN Output	PNP Output
Twin-output models	Area output, open circuit detection, Differential operation	E2C-EDA11	E2C-EDA41
External-input models	Remote setting, Differential operation	E2C-EDA21	E2C-EDA51

### Amplifier Units with Connector<sup>\*2</sup>

Item	Sensing Distance	Model	
		NPN Output	PNP Output
Twin-output models	Area output, open circuit detection, Differential operation	E2C-EDA6	E2C-EDA8
External-input models	Remote setting, Differential operation	E2C-EDA7	E2C-EDA9

<sup>\*2</sup> Order connector E3X-CN21 separately. See E3X-DA-S in Fiber-Optic Sensors for details.

## Inductive Sensor Detects All Metals at Equal Distance

- One sensor detects all kinds of metal at equal distance
- Detect aluminum up to 3x conventional sensing distance
- Shielded for flush mounting in metal
- Sensing distance: 2 mm (M12); 5 mm (M18); 10 mm (M30)
- Rated IP67, resists water splash and oil contamination



## E2CY Proximity Sensors

## Inductive Sensor Detects Aluminum in Tight Spaces

- Compact sensing heads and separate amplifier for mounting flexibility
- Detect differences between object types, object position, distance within a range
- Monitor operation with excess gain level bar graph indicator and diagnostic output
- One-touch teaching for sensitivity adjustment
- Shielded for flush mounting in metal
- Sensing distance by sensing head:
  - 1.5 mm (M5 and unthreaded 5.4 mm dia.)
  - 2 mm (unthreaded 8 mm dia.)
  - 3 mm (flat)
- Pre-wired sensing heads and amplifier each with 2 m cable
- Sensing heads rated IP67



## Inductive Sensor for Aluminum and Non-Ferrous Metals

- Detects non-magnetic ones such as aluminum, copper and brass and ignores ferrous materials
- Shielded for flush mounting in metal
- Sensing distance: 4 mm (M18) and 8 mm (M30)
- Rated IP67, resists water splash and oil contamination



## E2EZ Proximity Sensors

## Cutting Chip Resistant Inductive Sensor

- Detects objects without influence of accumulated aluminum and cast iron cutting chips
- Ideal for machine tool applications
- Sensing distance: 4 mm (M18) and 8 mm (M30)
- Shielded for flush mounting in metal
- DC 2-wire, DC 3-wire and AC 2-wire models
- Rated IP67, resists water splash and oil contamination



## Contents

### Connector Cordsets

XS2F/ XS2W	M12 Cordsets	M-2
XS5F	M12 Smartclick Cordsets	M-4
XS3F/ XS3W	M8 Cordsets	M-6
Y96E-M12	Connectors for AC cables	M-9
XW3D	Connector terminal boxes	M-10
E39-VA	Handy checker for sensors	M-10

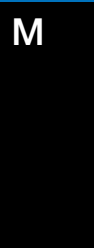

## Water- and Environment-Resistant M12 Connectors Save Wiring and Maintenance Effort

- Single-ended cables with M12 connectors satisfy IP67 requirements and ensure a 94V-0 fire retardant rating.
- Connectors make wiring a system more modular, simplify maintenance, and reduce downtime.
- Connectors with Cables and Connector Assemblies are available.



## Extension Cordsets, Two Single Key Molded M12 Sensor Connectors

Description				Model
Connector Type	Keyway	Cable Size	Length	Straight Connector
4-wire DC female socket and male plug	Single	22 AWG	2 m (6.56 ft.)	XS2W-D421-D81-F
			5 m (16.40 ft.)	XS2W-D421-G81-F

## Plug and Socket Field Wireable Assemblies

Description				Model
Connector Type	Keyway	Cable Size	Length	Straight Connector
M12 male plug	Single	5 to 6 mm dia	58.7 mm	XS2G-D4S1
M12 female socket			54.9 mm	XS2C-D4S1
<b>Insulation Displacement Contact</b>				
M12 male plug	Single	2 to 8 mm dia.	66 m	XS5G-D418
M12 female socket			62.4 mm	XS5C-D418





## XS2F - M12 Single-ended Cable with Socket

Connector	Size	Cores	Shape	Length (m)	PVC Cable Model	PUR Cable Model
Socket	M12	3	Angled	2	XS2F-M12PVC3A2M	XS2F-M12PUR3A2M
				5	XS2F-M12PVC3A5M	XS2F-M12PUR3A5M
				10	XS2F-M12PVC3A10M	XS2F-M12PUR3A10M
			Straight	2	XS2F-M12PVC3S2M	XS2F-M12PUR3S2M
				5	XS2F-M12PVC3S5M	XS2F-M12PUR3S5M
				10	XS2F-M12PVC3S10M	XS2F-M12PUR3S10M
		4	Angled	2	XS2F-M12PVC4A2M	XS2F-M12PUR4A2M
				5	XS2F-M12PVC4A5M	XS2F-M12PUR4A5M
				10	XS2F-M12PVC4A10M	XS2F-M12PUR4A10M
			Straight	2	XS2F-M12PVC4S2M	XS2F-M12PUR4S2M
				5	XS2F-M12PVC4S5M	XS2F-M12PUR4S5M
				10	XS2F-M12PVC4S10M	XS2F-M12PUR4S10M
		5	Angled	2	XS2F-M12PVC5A2M	XS2F-M12PUR5A2M
				5	XS2F-M12PVC5A5M	XS2F-M12PUR5A5M
				2	XS2F-M12PVC5S2M	XS2F-M12PUR5S2M
			Straight	5	XS2F-M12PVC5S5M	XS2F-M12PUR5S5M

### Dimensions

#### Straight

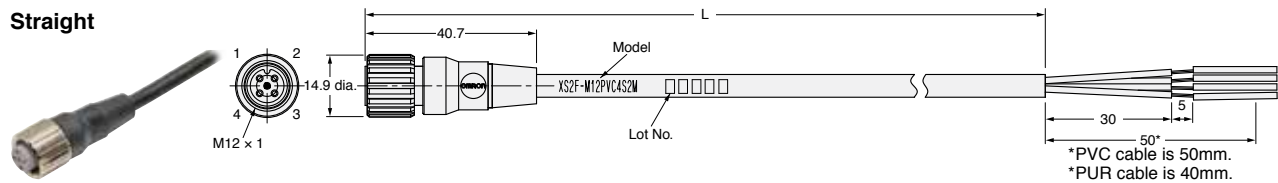

#### Right-angle

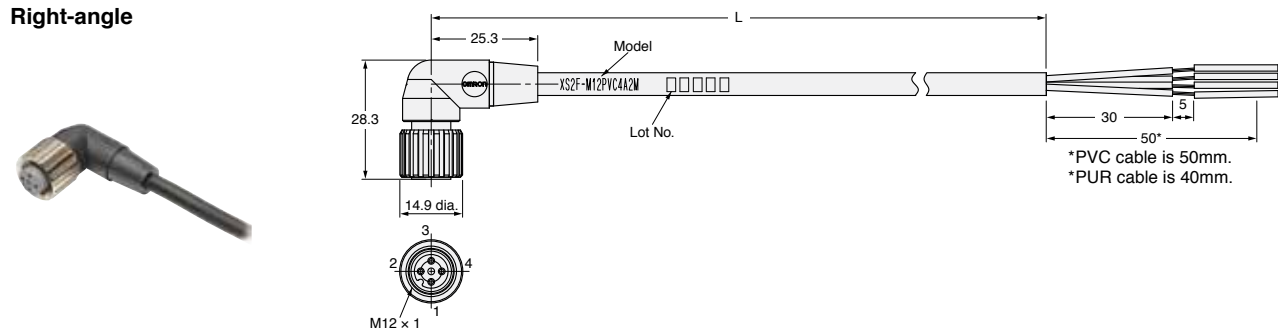

Note: For 3-core, pin 2 is not connected internally

3 cores	4 cores	5 cores

M

## XS2W-M12 Double-ended Connector Cable

Cable type	No. of cable cores	Cable outer diameter	Cable connection direction	Cable length (m)	Model
PVC	4	5.0 dia.	Straight/Straight	2	XS2W-M12PVC4SS2M
				5	XS2W-M12PVC4SS5M
				10	XS2W-M12PVC4SS10M
			Straight (Plug)/Angled (Socket)	2	XS2W-M12PVC4SA2M
				5	XS2W-M12PVC4SA5M
				10	XS2W-M12PVC4SA10M
PUR	4	4.7 dia.	Straight/Straight	2	XS2W-M12PUR4SS2M
				5	XS2W-M12PUR4SS5M
				10	XS2W-M12PUR4SS10M
			Straight (Plug)/Angled (Socket)	2	XS2W-M12PUR4SA2M
				5	XS2W-M12PUR4SA5M
				10	XS2W-M12PUR4SA10M

### Dimensions

(Unit: mm)

#### Straight/Straight

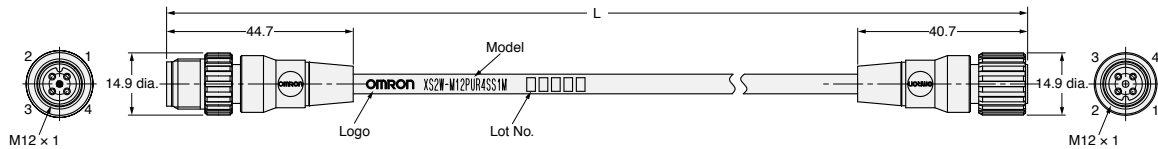

#### Straight (Plug)/Angled (Socket)

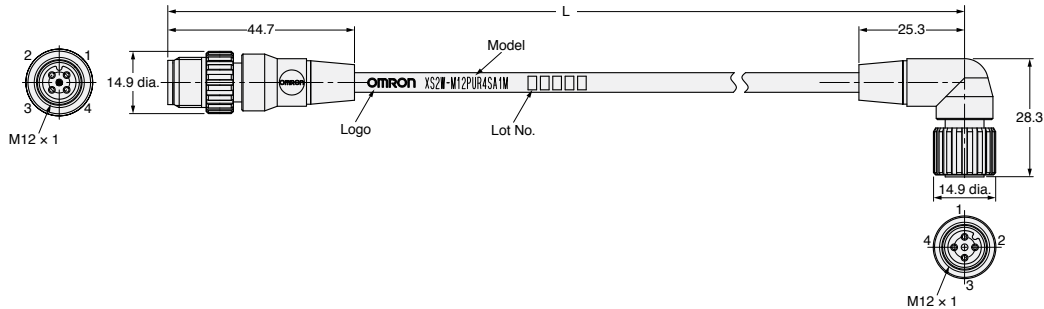

Note: For 3-core, pin 2 is not connected internally

### Wiring Diagram

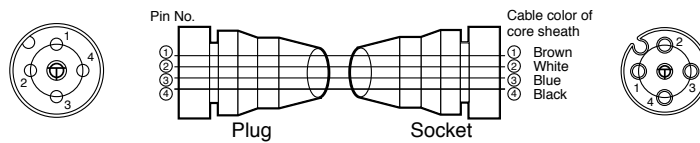

## Premium M12 Smartclick Connectors

- Single-ended cables with M12 connectors
- Smartclick offers a fast, one-step connection with only a 1/8th turn lock
- Smartclick can connect with standard screw-type M12 connectors
- IP67 water resistance



## Dimensions

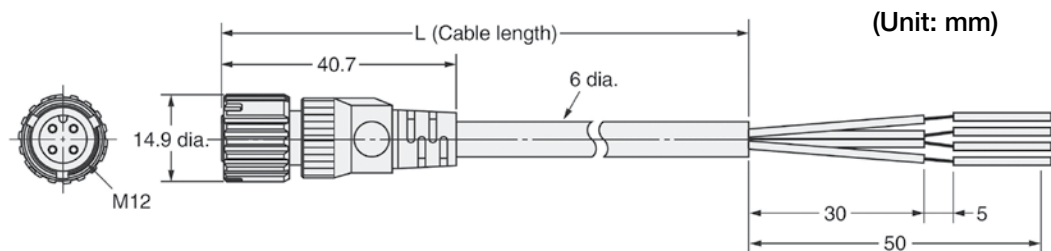

## Wiring Diagram

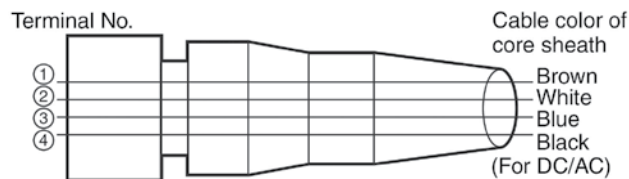

Note: The cover of the Oil-resistant Polyurethane Cable (XS5F-D421-□81-P) is black, and the cover of the Vibration-proof Robot Cable (XS5F-D421-□81-F) is warm gray.

## Ordering Information

Cable type	Cable connection direction	No. of cable cores	Cable length	Model
Vibration-proof robot cable	Straight	4	1	XS5F-D421-C80-F
			2	XS5F-D421-D80-F
			3	XS5F-D421-E80-F
			5	XS5F-D421-G80-F
			10	XS5F-D421-J80-F
Oil-resistant polyurethane cable	Straight	4	2	XS5F-D421-D80-P
			5	XS5F-D421-G80-P
			10	XS5F-D421-J80-P

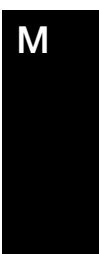

## Compact, Watertight M8 Connectors

- Water-resistive, compact connector meets IP67 requirements.
- Using connectors for wiring ensures ease of equipment maintenance and reduces downtime required for equipment maintenance.



### XS3F - M8 Single-ended Cable with Socket

Connector	Size	Cable Material	Poles	Type	Length	Model
Socket	M8	PVC	3	Angled	2	XS3F-M8PVC3A2M
					5	XS3F-M8PVC3A5M
					10	XS3F-M8PVC3A10M
				Straight	2	XS3F-M8PVC3S2M
					5	XS3F-M8PVC3S5M
					10	XS3F-M8PVC3S10M
			4	Angled	2	XS3F-M8PVC4A2M
					5	XS3F-M8PVC4A5M
					10	XS3F-M8PVC4A10M
				Straight	2	XS3F-M8PVC4S2M
					5	XS3F-M8PVC4S5M
					10	XS3F-M8PVC4S10M
		PUR	3	Angled	2	XS3F-M8PUR3A2M
					5	XS3F-M8PUR3A5M
					10	XS3F-M8PUR3A10M
				Straight	2	XS3F-M8PUR3S2M
					5	XS3F-M8PUR3S5M
					10	XS3F-M8PUR3S10M
			4	Angled	2	XS3F-M8PUR4A2M
					5	XS3F-M8PUR4A5M
					10	XS3F-M8PUR4A10M
				Straight	2	XS3F-M8PUR4S2M
					5	XS3F-M8PUR4S5M
					10	XS3F-M8PUR4S10M

## Dimensions

(Unit: mm)

### Straight

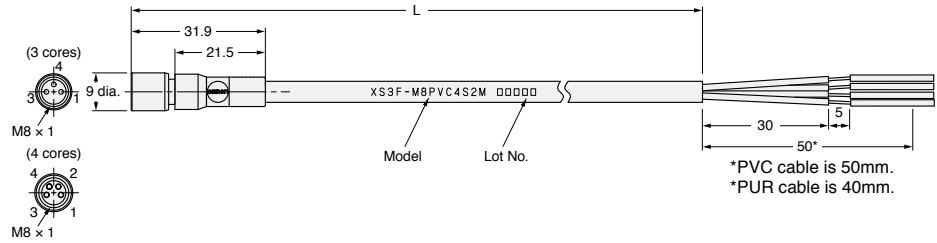

### Right-angle

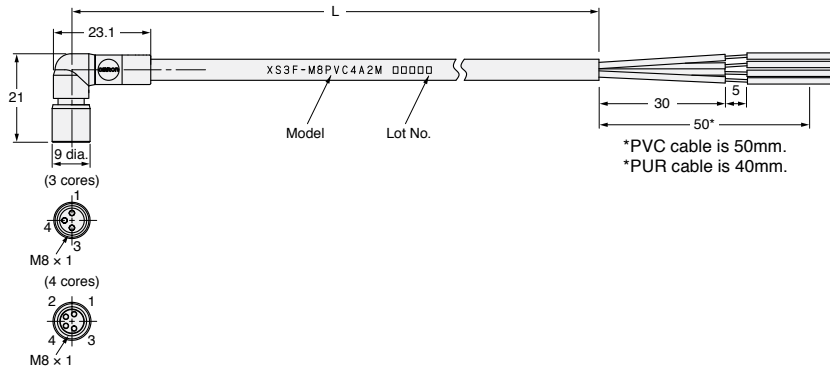

## Wiring Diagram

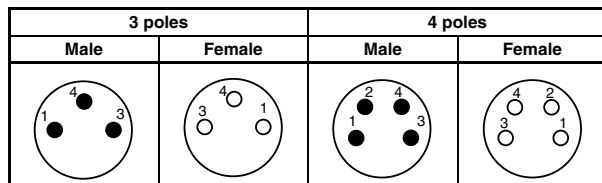
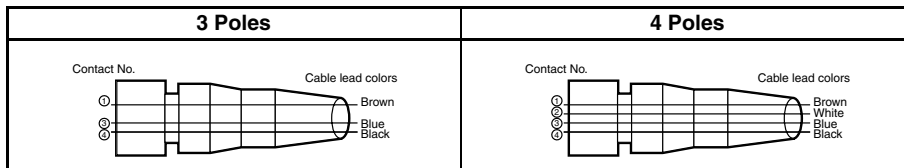

## Extension Cordsets, Two Single Key Molded M8 Sensor Connectors

Description					Model
Connector Type	Keyway	Cable Size	Cable Type	Length	Straight Connector
4-wire DC female socket and male plug	Single	22 AWG	Robotic	1 m (3.28 ft.)	XS3W-M421-401-R
				2 m (6.56 ft.)	XS3W-M421-402-R

M

## XS3W-M8 Double-ended Connector Cable

Cable type	No. of cable cores	Cable outer diameter	Cable connection direction	Cable length (m)	Model
PVC	3	5.0 dia.	Straight/Straight	2	XS3W-M8PVC3SS2M
				5	XS3W-M8PVC3SS5M
				10	XS3W-M8PVC3SS10M
			Straight (Plug)/Angled (Socket)	2	XS3W-M8PVC3SA2M
				5	XS3W-M8PVC3SA5M
				10	XS3W-M8PVC3SA10M
	4	5.0 dia.	Straight/Straight	2	XS3W-M8PVC4SS2M
				5	XS3W-M8PVC4SS5M
				10	XS3W-M8PVC4SS10M
			Straight (Plug)/Angled (Socket)	2	XS3W-M8PVC4SA2M
				5	XS3W-M8PVC4SA5M
				10	XS3W-M8PVC4SA10M
PUR	3	4.3 dia.	Straight/Straight	2	XS3W-M8PUR3SS2M
				5	XS3W-M8PUR3SS5M
				10	XS3W-M8PUR3SS10M
			Straight (Plug)/Angled (Socket)	2	XS3W-M8PUR3SA2M
				5	XS3W-M8PUR3SA5M
				10	XS3W-M8PUR3SA10M
	4	4.7 dia.	Straight/Straight	2	XS3W-M8PUR4SS2M
				5	XS3W-M8PUR4SS5M
				10	XS3W-M8PUR4SS10M
			Straight (Plug)/Angled (Socket)	2	XS3W-M8PUR4SA2M
				5	XS3W-M8PUR4SA5M
				10	XS3W-M8PUR4SA10M

### Dimensions

(Unit: mm)

#### Straight/Straight

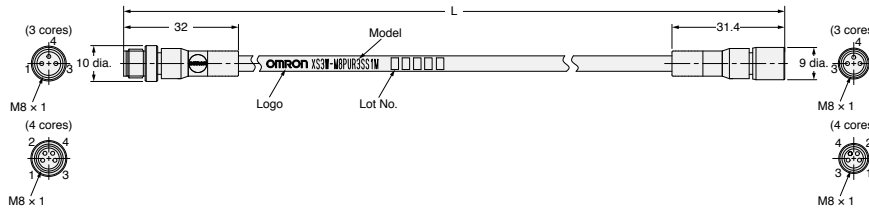

#### Straight (Plug)/Angled (Socket)

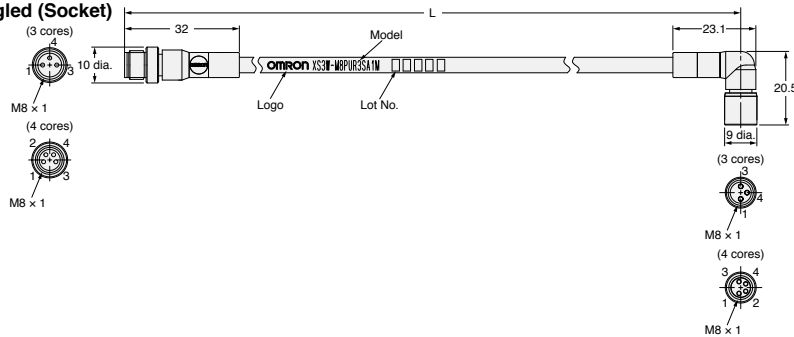

### Wiring Diagram

#### 3 poles

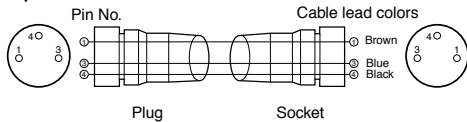

#### 4 poles

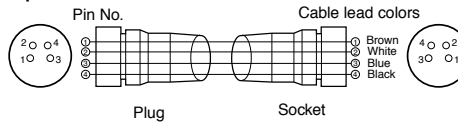

## AC Cordsets with M12 Micro-Change® Connectors

- Quick-disconnect AC cordsets allow easy installation and replacement of AC sensors
- Female 3-pole dual keyway socket
- Oil-resistant, PVC jacketed cable with internal metal sheath protects conductors against cuts and abrasions
- Straight and right-angle connector cordsets available
- Rated IP67
- UL recognized, CSA certified



## Micro-Change®: Registered trademark of Woodhead Industries

Description				Model	
Connector Type	Keyway	Cable Size	Length	Straight Connector	Right Angle Connector
3-wire AC, female Micro-Change® socket	Dual	22 AWG	6 ft.	Y96E-33SA6	Y96E-33RA6
			12 ft.	Y96E-33SA12	Y96E-33RA12
			20 ft.	Y96E-33SA20	Y96E-33RA20

### Straight Connector Cordsets

#### Y96E-33SA□

Gold/palladium/nickel plated brass contacts

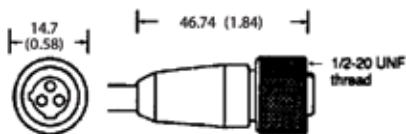

### Face View Female Connector

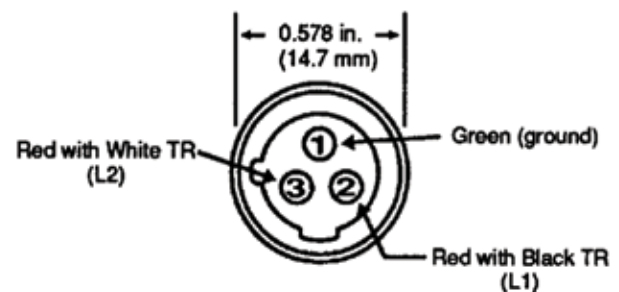

### Right Angle Connector Cordsets

#### Y96E-33RA□

Gold/palladium/nickel plated brass contacts

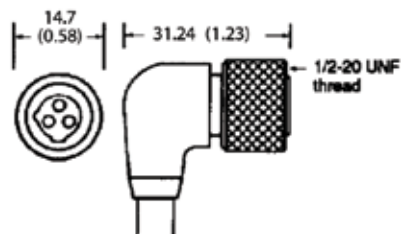

M

## Simple Wiring of Sensor Actuators

- Greatly reduces wiring work
- Higher rated current to enable output applications.
- Compatible with other M12 screw connectors.
- Degree of protection : IP67 (IEC60529)

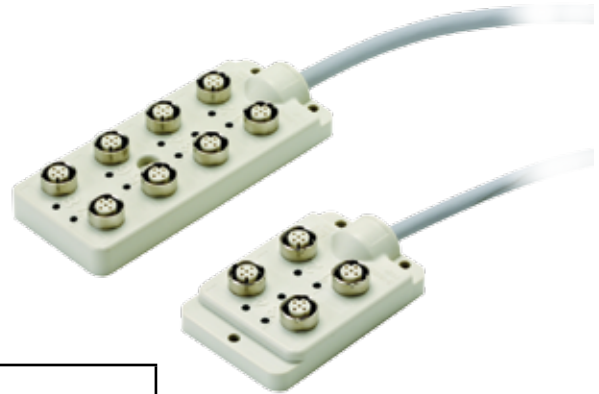

## Ratings and Specifications

Rated current	4 A/port, 12 A/Box (power line)
Rated voltage	10 to 30 VDC
Contact resistance (connector)	40 mΩ max. (20 mV max., 100 mA max.)
Insulation resistance	100 mΩ min. (at 500 VDC)
Dielectric strength (connector)	500 VAC for 1 min. (leakage current: 1 mA max.)
Insertion tolerance	50 times min.
Ambient operating temperature range	-25 to 70°C

## Ordering Information

Sensor type and wiring		3-Wire DC NPN/2-Wire DC 3-4	2-Wire DC 1-4/Without polarity 3-4	3-Wire DC PNP/2-Wire DC 1-4
Actuator wiring		Actuator wiring 1-4	-	Actuator wiring 3-4
No. of ports	No. of I/O	Model	Model	Model
4	4	XW3D-P455-G11	XW3D-P452-G11	XW3D-P453-G11
8	8	XW3D-P855-G11	XW3D-P852-G11	XW3D-P853-G11
4	8	XW3D-P458-G11	-	XW3D-P457-G11

Note: 1. "1-4" and "3-4" are the connector pin numbers that are wired.  
2. All cables are 5 m long.

# E39-VA Hand-held Checker

## Handheld Power Supply to Check Sensor Operation

- Portable Power Supply Unit for Sensors
- Check sensor operation via buzzer and LED indicator
- Low battery indicator for easy battery maintenance
- Use with both PNP and NPN three wire sensors



Ratings	Description	Model
Power supply voltage	18 V (use two 9 V dry-cell batteries)	E39-VA

Note: Two 9 VDC dry-cell batteries are included.



## Contents

Selection Guide		N-ii
<b>Slotted</b>		
EESX95□	Ultra-small, 5 mm slot sensors	N-1
EE-SX77□/ EE-SX87□	Thin profile, pre-wired 5 mm slot sensors	N-2
EE-SX47□/ EESX-67□	Plug-in or pre-wired slotted sensors	N-3
EE-SX97□	Plug-in slot sensors with reduced mounting depth	N-5
EE-SPX74□/ EE-SPX84□	Plug-in light modulated slot sensors	N-6
EE-SPX301/ EE-SPX401	Plug-in 3.6 mm slot sensors	N-7
EE-SPX-W2A	Pre-wired light modulated slot sensors	N-8
EE-SPX303N/ EE-SPX403N	Plug-in 13 mm slot sensors	N-9
<b>Reflective</b>		
EE-SPY31□/ EE-SPY-41□	Reflective plug-in sensors	N-10
EE-SY671/ EE-SY672	Adjustable sensitivity reflective plug-in sensors	N-11
EE-SPY301/ 302/401/402	Reflective sensors with plug-in/solder terminals	N-7
<b>Through-Beam</b>		
EE-SPW311/ EE-SPW411	Long-distance miniature built in amp	N-12
EE-SPW321/ EE-SPW421	Miniature sensing heads with in-line cable amplifier	N-13
<b>Special Application</b>		
EE-SPX613	Liquid level sensor	N-14
EE-SPZ-A	Retro-reflective sensor	N-15
EE-SA701/ EE-SA801	Pushbutton actuator sensors	N-16
EE-SPY801/ EE-SPY802	Wafer carrier mounting sensor	N-17

## SMALL SENSORS DELIVER PRECISE POSITIONING



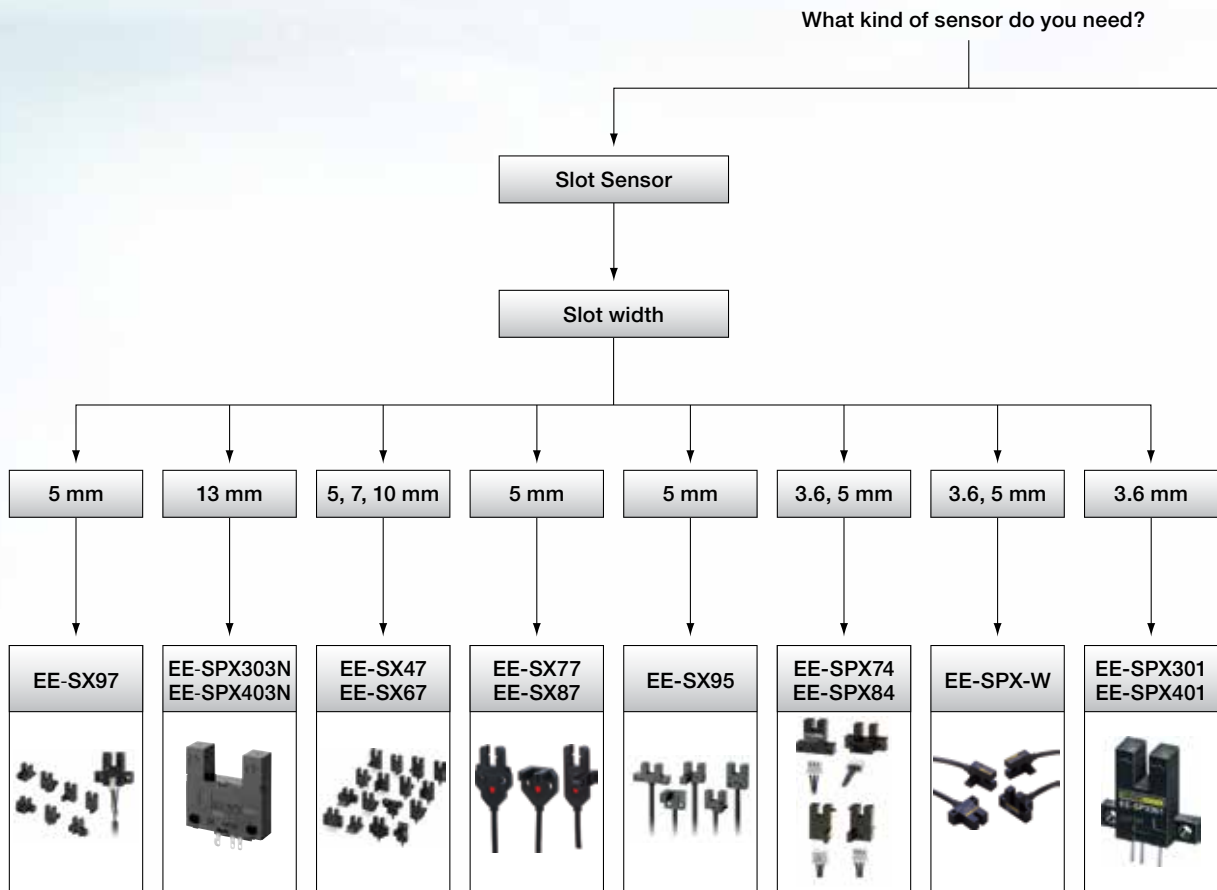

Continuous miniaturization of robots and machinery for semiconductor, photovoltaic and electronics manufacturing require increasingly precise positioning data to maximize production yield and maintain high quality. Amplified Photomicrosensors deliver high precision in a simply mounted format. Embed them in rails for robots, X-Y positioning tables and conveyors for end-of-travel and home position inputs. All are designed for easy connection to PLCs and other controllers as part of a motion control solution.

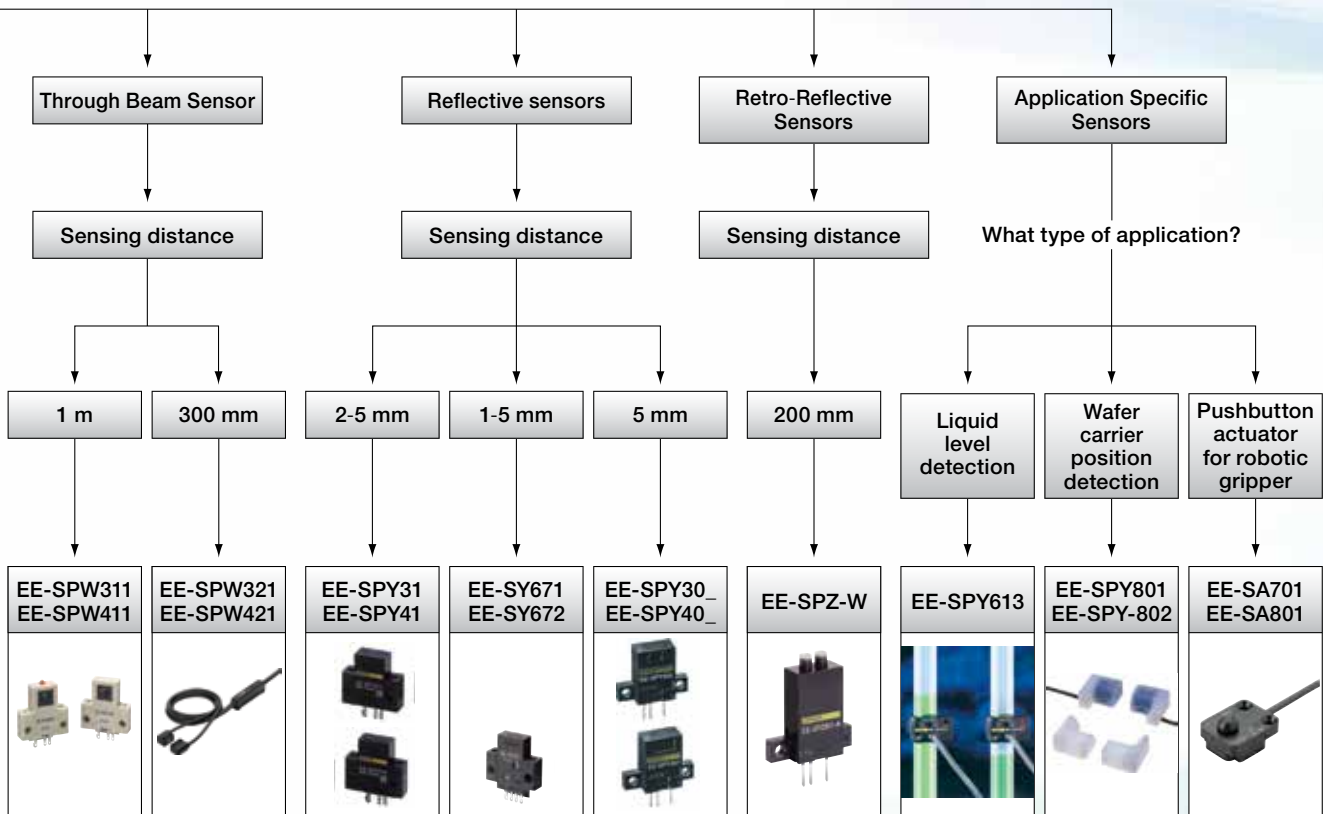
- Wide choice of models: slotted, through-beam, reflective, and retro-reflective
- Special application solutions for liquid level detection, wafer carrier positioning, and object confirmation for robotic grippers













# Selection Table

Type	Slotted Through-Beam			
				
Model	EE-SX95	EE-SX77/87	EE-SX47/67	EE-SPX74/84
Features	<ul style="list-style-type: none"> <li>Indicator visible from many directions</li> <li>Mount using M2 or M3 Screws</li> <li>Robot Cable option</li> </ul>	<ul style="list-style-type: none"> <li>Compact size</li> <li>Indicator visible from both sides</li> <li>M3 mounting holes and slotted mounting holes for easy adjustment</li> </ul>	<ul style="list-style-type: none"> <li>Visible indicator from many directions</li> <li>Response frequency as high as 1 kHz</li> <li>Robot Cable standard on pre-wired models</li> </ul>	<ul style="list-style-type: none"> <li>4 models</li> <li>Connectors with locks for vibration applications</li> <li>Mount with M3 screws</li> </ul>
Housing material	Polybutylene terephthalate (PBT) (Case/Cover) Polycarbonate (PC) (Emitter/receiver)	Polybutylene terephthalate (PBT)	Polybutylene terephthalate (PBT) (Case/Cover) Polycarbonate (PC) (Emitter/receiver)	Polycarbonate (PC)
Sensing distance	5 mm slot width	5 mm slot width	5 mm slot width	3.6 or 5 mm slot width
Output type	NPN, PNP	NPN, PNP	NPN, PNP	NPN
Output configuration	Light-On or Dark-On	Light-On or Dark-On	Light-On/Dark-On (selectable)	Light-On or Dark-On
Supply voltage	5 – 24 VDC	5 – 24 VDC	5 – 24 VDC	5 – 24 VDC
Connection type	<ul style="list-style-type: none"> <li>Pre-wired (4 wire cable) (1 m std length)</li> </ul>	<ul style="list-style-type: none"> <li>Pre-wired (3 wire cable) (2 m std length)</li> </ul>	<ul style="list-style-type: none"> <li>4 wire cable (1 m std length)</li> <li>Solder Connector</li> <li>Connector with 1 m Cable</li> </ul>	<ul style="list-style-type: none"> <li>Special Connector (EE-1013 with 1 m cable)</li> </ul>





# Photomicrosensors

Type	Slotted Through-Beam			Diffuse Reflective
				
Model	EE-SX97	EE-SPX-W2A	EE-SPX-303N/403N	EE-SPY31_
Features	<ul style="list-style-type: none"> <li>• Reduced mounting height from deeply embedded socket</li> <li>• 7 mounting shapes</li> <li>• Indicator visible from 4 directions</li> <li>• Locking connectors for secure wiring</li> </ul>	<ul style="list-style-type: none"> <li>• 4 models</li> <li>• Light Modulation to reduce external light interference</li> <li>• Bright Light Indicator</li> </ul>	<ul style="list-style-type: none"> <li>• Widest Slot type</li> <li>• Resistant to common noise</li> </ul>	<ul style="list-style-type: none"> <li>• Can be used in front of shiny background</li> <li>• Small object detection (0.05 mm dia.)</li> <li>• Light modulation reduces external light interference</li> </ul>
Housing material	Polybutylene terephthalate (PBT) (Case/Cover) Polycarbonate (PC) (Emitter/receiver)	Polycarbonate (PC)	Polycarbonate (PC)	Polycarbonate PC (case) Polybutylene terephthalate PBT (holder)
Sensing distance	5 mm slot width	3.6 or 5 mm slot width	13 mm slot width	2 to 5 mm
Output type	NPN, PNP	NPN	NPN	NPN
Output configuration	Light-On and Dark-On	Light-On or Dark-On	Light-On or Dark-On	Light-On or Dark-On
Supply voltage	5 – 24 VDC	5 – 24 VDC	5 – 24 VDC	5 – 24 VDC
Connection type	<ul style="list-style-type: none"> <li>• Commercially available connector: EE-1017 with 1 m or 3 m cable; EE-1017-R with 1 m or 3 m robotic cable</li> </ul>	<ul style="list-style-type: none"> <li>• Pre-wired (3 wire cable) (1 m std length)</li> </ul>	<ul style="list-style-type: none"> <li>• Connector with standard cable</li> <li>• Connector with robot cable</li> <li>• NPN to PNP Conversion connector</li> </ul>	<ul style="list-style-type: none"> <li>• Connector with standard cable</li> <li>• Connector with robot cable</li> <li>• NPN to PNP Conversion connector</li> </ul>

# Selection Table

Type	Diffuse Reflective		Through-beam	
				
Model	EE-SY671/672	EE-SPX301/401 EE-SPY301/401	EE-SPW311/411	EE-SPW321/421
Features	<ul style="list-style-type: none"> <li>Built in sensitivity adjustment</li> <li>Built-in amplifier with 100 mA capacity</li> <li>Bright indicator light</li> </ul>	<ul style="list-style-type: none"> <li>Light Modulation, sensor not affected by external light</li> <li>Optical Axis mark for easy adjustment</li> </ul>	<ul style="list-style-type: none"> <li>Through Beam</li> <li>Easy-to wire connector</li> <li>Bright indicator light</li> </ul>	<ul style="list-style-type: none"> <li>Cable mounted amplifier for space savings mounting</li> <li>Through beam</li> <li>Both sensor head and amplifier have indicating lights</li> </ul>
Housing material	Polybutylene terephthalate (PBT) (Case/Cover) Polycarbonate (PC) (Emitter/receiver)	Polycarbonate (PC)	Polybutylene terephthalate (PBT) (Case/Cover) Polycarbonate (PC) (Emitter/receiver)	ABS Resin (case) Acrylic Resin (lens)
Sensing distance	1 to 5 mm	3 - 6 mm slot width or 5 mm distance	1 m	300 mm max. distance between sensing heads
Output type	NPN	NPN	NPN	NPN
Output configuration	Light-On/Dark-On (selectable)	Light-On or Dark-On	Light-On or Dark-On	Light-On or Dark-On
Supply voltage	5 – 24 VDC	5 – 24 VDC	5 – 24 VDC	12 – 24 VDC
Connection type	<ul style="list-style-type: none"> <li>Connector only</li> <li>Connector with cable</li> <li>Connector with robot cable</li> </ul>	<ul style="list-style-type: none"> <li>Connector only</li> <li>Connector with cable</li> <li>NPN to PNP Conversion connector</li> </ul>	<ul style="list-style-type: none"> <li>Connector with 2 m cable</li> </ul>	<ul style="list-style-type: none"> <li>Pre-wired 2 m cable</li> </ul>

# Photomicrosensors

Type	Retro-reflective	Liquid level	Pushbutton actuator	Wafer carrier positioning
				
Model	EE-SPZ-A	EE-SPX613	EE-SA701-/801	EE-SPY801/802
Features	<ul style="list-style-type: none"> <li>• Longer sensing distance, simpler to align than diffuse and through-beam sensors</li> <li>• Supports connection with PLCs</li> </ul>	<ul style="list-style-type: none"> <li>• Can mount on 6 mm to 13 mm diameter pipe</li> <li>• Liquid level indicator</li> <li>• Built-in sensitivity selector</li> </ul>	<ul style="list-style-type: none"> <li>• Pushbutton actuator detects FOUNC cassettes loading on robotic transfer arms</li> <li>• 5 million operation mechanical life</li> </ul>	<ul style="list-style-type: none"> <li>• Diffuse reflective sensors detect leg section of wafer carriers</li> <li>• Pedestals guide carrier for detection</li> <li>• Left- and right-hand models</li> </ul>
Housing material	Polycarbonate (PC)	Polycarbonate (PC)	Polycarbonate (PC) (Base) Polyacetal (Actuator)	Ethylene tetrafluoro ethylene (ETFE) case Polybutylene terephthalate (PBT) base plate
Sensing distance	200 mm	6-13 mm dia. pipe	3.5-4.5 mm operating position	0-3 mm
Output type	NPN	NPN	NPN or PNP	NPN
Output configuration	Light-On or Dark-On	Light-On/Dark-On (selectable)	—	Dark-On
Supply voltage	5 – 24 VDC	12 – 24 VDC	12 – 24 VDC	12 – 24 VDC
Connection type	<ul style="list-style-type: none"> <li>• Connector only</li> <li>• Connector with cable</li> <li>• NPN to PNP Conversion connector</li> </ul>	<ul style="list-style-type: none"> <li>• Pre-wired 1 m cable</li> </ul>	<ul style="list-style-type: none"> <li>• Pre-wired 1 m cable</li> <li>• Pre-wired 1 m robot cable</li> </ul>	<ul style="list-style-type: none"> <li>• Pre-wired with 2 m, talc-free cable</li> </ul>

## Ultra-Small Size for Space Constrained Locations

- 5 body shapes enable easier fit and alignment
- Indicator light can be viewed from 4 directions for simple installation and operation
- Easy to mount with either M2 or M3 screws
- Flexible robot cable options available, ideal for moving part applications
- Wire selectable Dark-ON or Light-ON output

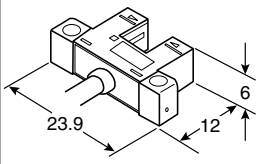

## Sensors

Appearance	Sensor method	Sensing distance	Output configuration	Connection method (cable length)	Output type	Model
<b>Standard</b> 	Through-beam (with slot)	Infrared light 5 mm (slot width)	Light-ON Dark-ON (2 outputs)	Pre-wired model with standard cable (1 m)	NPN	EE-SX950-W 1M <sup>*1,3</sup>
					PNP	EE-SX950P-W <sup>*2</sup>
Pre-wired model with robot cable (1 m)				NPN	EE-SX950-R 1M <sup>*1</sup>	
Pre-wired model with standard cable (1 m)				NPN	EE-SX951-W 1M <sup>*1,3</sup>	
				PNP	EE-SX951P-W 1M <sup>*2</sup>	
Pre-wired model with robot cable (1 m)				NPN	EE-SX951-R 1M <sup>*1</sup>	
Pre-wired model with standard cable (1 m)				NPN	EE-SX952-W 1M <sup>*1,3</sup>	
				PNP	EE-SX952P-W 1M <sup>*2</sup>	
Pre-wired model with robot cable (1 m)				NPN	EE-SX952P-R 1M <sup>*1</sup>	
Pre-wired model with standard cable (1 m)				NPN	EE-SX953-W 1M <sup>*1,3</sup>	
				PNP	EE-SX953P-W 1M <sup>*2</sup>	
Pre-wired model with robot cable (1 m)				NPN	EE-SX953-R 1M <sup>*1</sup>	
Pre-wired model with standard cable (1 m)	NPN	EE-SX954-W 1M <sup>*1,3</sup>				
	PNP	EE-SX954P-W 1M <sup>*2</sup>				
Pre-wired model with robot cable (1 m)	NPN	EE-SX954-R 1M <sup>*1</sup>				

\*1. A model with a 3 m cable is available. The model number is EE-SX95□-□3M. (Example: EE-SX950-W 3M)

\*2. A pre-wired model with PNP output and 1 m cable is available. The model number is EE-SX95□P-R 1M. (Example: EE-SX950P-R 1M).

\*3. A model with 0.3 m cable and connector type is available. The model number is EE-SX95□-C1J-R 0.3M. (Example: EE-SX950-C1J-R 0.3M)





### Pre-Wired Photomicrosensors with Open Collector Output

- Standard, L-shaped, and T-shaped models available
- Pre-wired with 2 m flexible cable that conforms to machine contours
- Models available with Light-ON or Dark-ON output configurations
- Response frequency as high as 1 kHz
- Easy to monitor, indicators are visible from both sides
- Indicator turns OFF when light is interrupted; opposite operation models available
- Readily-visible, molded workpiece insertion mark allows fine-tuning of sensing position
- Allows standard M3-screw mounting
- Wide operating voltage range simplifies sensor connection to TTLs, relays, and programmable controllers (PLC)
- Ideal for use in end-of-travel, home position and operation trigger applications



### Pre-Wired Slotted Photomicrosensors









Appearance	Sensor type	Slot width/depth	Dimensions H x W x D mm	Output form	Output Type	Model
Standard 	Through-beam (slot)	5 mm W x 9 mm D	31.1 x 18 x 4.6	Light-ON	NPN	EE-SX870
					PNP	EE-SX870P
				Dark-ON	NPN	EE-SX770
					PNP	EE-SX770P
L-shaped 	Through-beam (slot)	5 mm W x 9 mm D	21 x 18 x 13	Light-ON	NPN	EE-SX871
					PNP	EE-SX871P
				Dark-ON	NPN	EE-SX771
					PNP	EE-SX771P
T-shaped 	Through-beam (slot)	5 mm W x 9 mm D	31.1 x 12.3 x 19.1	Light-ON	NPN	EE-SX872
					PNP	EE-SX872P
				Dark-ON	NPN	EE-SX772
					PNP	EE-SX772P

### Widest Variety of Body Shapes of Connector-Ready Slotted Sensors



- 8 body configurations available with connector, pre-wired cable or pre-wired connector
- Easy operation monitoring with bright LED indicator
- Choose Light-ON or Light-ON/Dark-ON output models
- Light modulation reduces external light interference
- Flexible robot cable is standard on all pre-wired models
- Wide operating voltage range simplifies sensor connection to TTLs, relays and programmable controllers (PLC)











### Connector-Ready Slotted Photomicrosensors

Shape	Sensor type	Slot width/depth	Dimensions H x W x D mm	Output form	Indicator operation	Output Type	Model		
	Through-beam	5 mm W x 9 mm H	28.4 x 25.4 x 6.95	Light-ON	Light-ON	NPN	EE-SX470		
				Light-ON/Dark-ON selectable	Dark-ON		EE-SX670		
					Light-ON		EE-SX670A		
				Dark-ON	PNP	EE-SX670P			
			15.5 x 26.2 x 20.7	Light-ON	Light-ON	NPN	EE-SX471		
							Light-ON/Dark-ON selectable	Dark-ON	EE-SX671
								Light-ON	EE-SX671A
						Dark-ON	PNP	EE-SX671P	
	7 mm W x 9 mm H	28.4 x 29 x 13.7	Light-ON	NPN	EE-SX472				
					Light-ON/Dark-ON selectable	Dark-ON	EE-SX672		
						Light-ON	EE-SX672A		
				Dark-ON	PNP	EE-SX672P			
			5 mm W x 9 mm H	28.4 x 13.4 x 12.8	Light-ON	NPN	EE-SX473		
							Light-ON/Dark-ON selectable	Dark-ON	EE-SX673
								Light-ON	EE-SX673A
						Dark-ON	PNP	EE-SX673P	
	15.5 x 13.6 x 27.7	Light-ON			Light-ON	NPN	EE-SX474		
							Light-ON/Dark-ON selectable	Dark-ON	EE-SX674
								Light-ON	EE-SX674A
						Dark-ON	PNP	EE-SX674P	
	10 mm W x 9 mm H	28.4 x 31 x 16.7	Light-ON	NPN	EE-SX675				
				PNP	EE-SX675P				
	5 mm W x 9 mm H	28.4 x 13.2 x 13.7	Light-ON	NPN	EE-SX676				
				PNP	EE-SX676P				
	5 mm W x 9 mm H	28.4 x 13.2 x 13.7	Light-ON	NPN	EE-SX677				
				PNP	EE-SX677P				

### Connectors and Accessories (continued)

Appearance	Item	Description	Dimensions H x W x D mm	Model
	Solder connector	—	16.8 x 13.0 x 4.0	EE-1001
		Makes selectable operation models into Light-ON operation sensors. The L and positive (+) terminals are already short-circuited.		EE-1001-1
		Connector has locking mechanism	13.5 x 13 x 4	EE-1009
	Connector with cable	2 m cable	11.8 x 16.2 x 5.3	EE-1006

### Pre-Wired Slotted Photomicrosensors





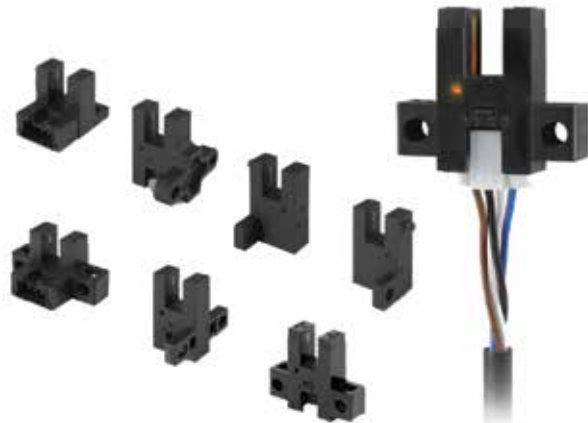

Shape	Sensor type	Slot width/depth	Dimensions H x W x D mm	Output form	Connection Method (cable length)	Model	
						NPN Output	PNP Output
	Through-beam	5 mm W x 9 mm H	28.4 x 25.4 x 6.95	Light-ON Dark-ON (selectable)	Pre-wired models (1 m)	EE-SX670-WR	EE-SX670P-WR
					Models with junction connectors (0.3 m)	EE-SX670-C1J-R	EE-SX670P-C1J-R
L-shaped 			15.5 x 26.2 x 20.7		Pre-wired models (1 m)	EE-SX671-WR	EE-SX671P-WR
			Models with junction connectors (0.3 m)		EE-SX671-C1J-R	EE-SX671P-C1J-R	
T-shaped 		7 mm W x 9 mm H	28.4 x 29 x 13.7		Pre-wired models (1 m)	EE-SX672-WR	EE-SX672P-WR
					Models with junction connectors (0.3 m)	EE-SX672-C1J-R	EE-SX672P-C1J-R
Close-mounting vertical 		5 mm W x 9 mm H	28.4 x 13.4 x 12.8		Pre-wired models (1 m)	EE-SX673-WR	EE-SX673P-WR
					Models with junction connectors (0.3 m)	EE-SX673-C1J-R	EE-SX673P-C1J-R
Close-mounting horizontal 		15.5 x 13.6 x 27.7	Pre-wired models (1 m)		EE-SX674-WR	EE-SX674P-WR	
			Models with junction connectors (0.3 m)		EE-SX674-C1J-R	EE-SX674P-C1J-R	
T-shaped 	10 mm W x 9 mm H	28.4 x 31 x 16.7	Pre-wired models (1 m)	EE-SX675-WR	EE-SX675P-WR		
			Models with junction connectors (0.3 m)	EE-SX675-C1J-R	EE-SX675P-C1J-R		
F-shaped 	5 mm W x 9 mm H	28.4 x 13.2 x 13.7	Pre-wired models (1 m)	EE-SX676-WR	EE-SX676P-WR		
			Models with junction connectors (0.3 m)	EE-SX676-C1J-R	EE-SX676P-C1J-R		
R-shaped 	28.4 x 13.2 x 13.7	Pre-wired models (1 m)	EE-SX677-WR	EE-SX677P-WR			
		Models with junction connectors (0.3 m)	EE-SX677-C1J-R	EE-SX677P-C1J-R			

## Space Saving Sensor with Secure Connector

- Deeply embedded socket reduces overall mounting height
- 7 shapes to match most applications
- Light-ON and Dark-ON outputs wire selectable
- PNP and NPN output models
- Locking connector for secure wiring
- Indicator visible from 4 directions
- Power reverse polarity protection and output overcurrent with thermal
- Shutdown circuit built into NPN output models



## Connector-Ready Slotted Photomicrosensors

Shape	Sensor type	Slot width/depth	Dimensions H x W x D mm	Output form	NPN output Model	PNP output model
	Through beam with slot	5 W x 9 D mm	22 x 26 x 6.8	Dark-ON/ Light-ON/ (selectable)	EE-SX970-C1	EE-SX970PC1
		5 W x 9 D mm	15.5 x 26.2 x 14.7		EE-SX971-C1	EE-SX971PC1
		5 W x 9 D mm slot center 7 mm	22 x 13.7 x 26		EE-SX972-C1	EE-SX972PC1
		5 W x 9 D mm	15.5 x 13.4 x 21.7		EE-SX974-C1	EE-SX974PC1
		5 W x 9 D mm slot center 10 mm	22 x 16.7 x 26		EE-SX975-C1	EE-SX975PC1
		5 W x 9 D mm	22 x 15.9 x 13.2		EE-SX976-C1	EE-SX976PC1
		5 W x 9 D mm	22 x 15.9 x 13.2		EE-SX977-C1	EE-SX977PC

## Connector

Description	Cable length	Model
Connector with standard cable	1 m	EE-1017 1M
	3 m	EE-1017 3M
Connector with robotic cable	1 m	EE-1017-R 1M
	3 m	EE-1017-R 3M

# EE-SPX74□/EE-SPX84□ Slotted Photomicrosensors

Quick Link

B425



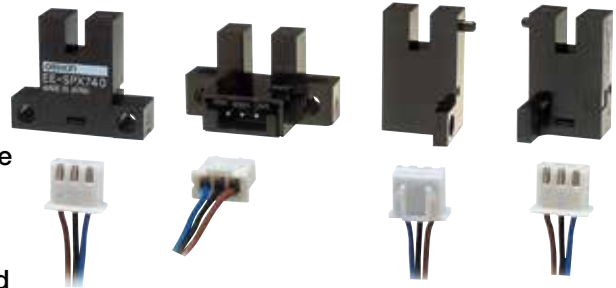

omron247.com

## Connector-Ready Photomicrosensors with Open Collector Output

- Compact sensor for high-density mounting
- Standard, L-shaped, and T-shaped models available
- Easy to maintain, plugs into Connector cordset EE-1013
- Connector features built-in safety lock vibration and shock resistance
- Models available with Light-ON or Light-ON/Dark-ON output configurations
- Powerful light modulation against external light interference
- Easy operation monitoring with bright LED indicator
- Wide operating voltage range simplifies sensor connection to TTLs, relays, and programmable controllers (PLC)
- Ideal for use in end-of-travel, home position and operation trigger applications



## Plug-In Slotted Photomicrosensors

Shape	Sensor type	Slot width/depth	Dimensions H x W x D mm	Output form	Model
 Standard	Through beam (slot)	3.6 mm W x 6.6 mm D	21.2 x 25 x 7.4	Light-ON	EE-SPX840
				Dark-ON	EE-SPX740
 L-shaped, left tab			21.2 x 15.5 x 13	Light-ON	EE-SPX842
				Dark-ON	EE-SPX742
 L-shaped, right tab			Light-ON	EE-SPX843	
			Dark-ON	EE-SPX743	
 T-shaped		5 mm W x 9 mm H	15.4 x 27.2 x 15.5	Light-ON	EE-SPX841
				Dark-ON	EE-SPX741

## Connector

Appearance	Item	Description	Dimensions H x W x D mm	Model
	Connector with cable	1 m cable	11.8 x 16.2 x 5.3	EE-1013

# EE-SPX301/401, -SPY301/302/401/402

## Slotted/Reflective Photomicrosensors

Quick Link  
B426  
omron247.com

### Narrow Slot Sensors and Reflective Sensors with Plug in Connection

- Slotted DC sensor with plug-in connection for counting and presence/absence detection applications
- Light modulation reduces external light interference
- Light-ON and Dark-ON operation models
- Built-in Light-ON indicator
- Connector simplifies installation and maintenance: choose connector with 1 m cable (EE-1003) or solder terminals (EE-1002)
- Convert EE-SPX301/401 NPN output to PNP with EE-2001 output converter



### Photomicrosensors

Appearance	Sensor type	Sensing distance	Dimensions H x W x D mm	Output type	Output form	Model
	Through beam with slot	3.6 W x 9 L mm slot	31.5 H x 26 W x 7 D mm	NPN	Dark-ON	EE-SPX301
					Light-ON	EE-SPX401
	Diffuse reflective	5 mm	27.5 H x 26 W x 7 D mm		Dark-ON	EE-SPY301
					Light-ON	EE-SPY401
	Diffuse reflective	5 mm	27.5 H x 26 W x 7 D mm		Dark-ON	EE-SPY302
					Light-ON	EE-SPY402

### Connectors and Accessories

Description	Model
Solder connector	EE-1002
Connector with cable 1 m length	EE-1003
Connector hold-down clip for EE-1003	EE-1003A
NPN/PNP conversion connector, 0.46 length	EE-2001

# EE-SPX-W2A

## Slotted Photomicrosensors

Quick Link

B427



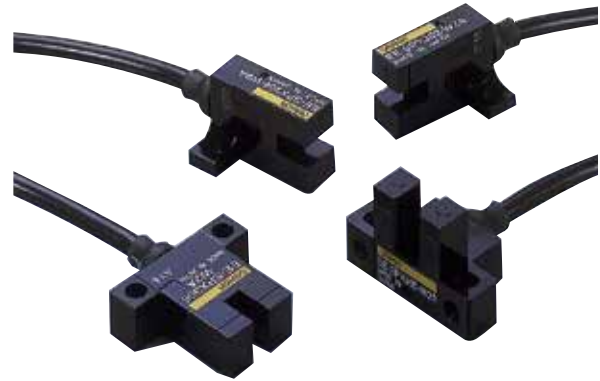

omron247.com

### Pre-Wired Photomicrosensors with Open Collector Output

- Compact sensor for high-density mounting
- Standard, L-shaped, and T-shaped models available
- Incorporating dust-proof slit
- Detects objects as small as 0.5 mm diameter
- Light-ON or Dark-ON output configurations models available
- Optical axis monitoring with a Light-ON indicator
- Light modulation effectively reduces external light interference
- Pre-wired with 2 m cable



### Pre-Wired Photomicrosensors

Appearance	Sensor type	Slot width/depth	Dimensions H x W x D mm	Output form	Output Type	Model	
 Standard	Through beam (slot)	3.6 mm W x 6.6 mm D	29.2 x 25 x 7.4	Light-ON	NPN	EE-SPX306-W2A	
				Dark-ON		EE-SPX406-W2A	
 L-shaped, left tab			29.2 x 15.5 x 13	Light-ON		EE-SPX302-W2A	
				Dark-ON		EE-SPX402-W2A	
 L-shaped, right tab			21.2 x 15.5 x 13	Light-ON		EE-SPX304-W2A	
				Dark-ON		EE-SPX404-W2A	
 T-shaped			5 mm W x 9 mm H	15.5 x 27.2 x 22.5		Light-ON	EE-SPX305-W2A
						Dark-ON	EE-SPX405-W2A

# EE-SPX303N/EE-SPX403N

## Slotted Photomicrosensors

Quick Link  
B428  
omron247.com

### Connector-Ready Wide Slot Sensors

- Large slot width (13 mm W x 10 mm D)
- Models available with Light-ON or Dark-ON output configurations
- Powerful light modulation against external light interference
- Easy adjustment and optical axis monitoring with a Light-ON indicator
- Convert to PNP output with EE-2002 conversion connector



### Wide Slot Photomicrosensors

Appearance	Sensor type	Slot width/depth	Dimensions H x W x D mm	Output form	Output Type	Model
	Through beam with slot	13 mm W x 10 mm D	26 x 26 x 7.4	Light-ON	NPN	EE-SPX303N
				Dark-ON		EE-SPX403N

### Connectors and Accessories

Appearance	Item	Description	Dimensions H x W x D mm	Model
	Solder connector	Connector makes selectable operation sensors into Light-ON operation sensors. Short-circuits L and positive (+) terminals.	16.8 x 13.0 x 4.0	EE-1001
	Connector with cable	2 m cable	11.8 x 16.2 x 5.3	EE-1006
	Connector holder	For EE-1006	25.2 x 29.2 x 5.5	EE-1006A
	Connector with cable	2 m cable	13.5 x 13.0 x 4.0	EE-1010
	Connector with robotic cable			EE-1010R
	NPN/PNP conversion connector		16.2 x 11.8 x 5.3	EE-2002





### Connector-Ready Reflective Sensors

- Detect dark colored objects and targets in front of mirror-like backgrounds
- Detect objects as small as 0.05 mm diameter copper wire
- 2 to 5 mm sensing distance
- Vertical and horizontal mounting models available
- Easy to maintain, plugs into Connector cordset EE-1006
- Light modulation effectively reduces external light interference
- Easy operation monitoring with bright LED indicator



### Plug-in Reflective

Appearance	Sensor type	Slot width/depth	Dimensions H x W x D mm	Output form	Output type	Model
Horizontal 	Convergent reflective	2-5 mm	29 x 26 x 8	Dark-ON	NPN	EE-SPY311
				Light-ON		EE-SPY411
Vertical 				Dark-ON		EE-SPY312
				Light-ON		EE-SPY412

# EE-SY671/EE-SY672

## Reflective Photomicrosensors

Quick Link

B432



omron247.com

### Reflective Sensors with Sensitivity Adjuster

- 1 to 5 mm sensing distance
- Vertical and horizontal mounting models available
- Light-ON/Dark-ON output wire selectable
- Light modulation effectively reduces external light interference
- Easy operation monitoring with bright LED indicator



### Pre-Wired Photomicrosensors

Appearance	Sensor type	Sensing distance	Dimensions H x W x D mm	Output form	Output type	Model
Horizontal 	Convergent reflective	1 to 5 mm	31.4 x 25.4 x 6.95	Light-ON/Dark-ON selectable	NPN	EE-SY671
Vertical 			31.2 x 25.4 x 6.95			EE-SY672

# EE-SPW311/EE-SPW411

## Through-Beam Photomicrosensors

Quick Link

B434

omron247.com

### Long Distance Miniature Sensors with Built-In Amplifier



- 1 meter sensing distance with 5 mm diameter minimum object size
- Models available with Light-ON or Dark-ON output configurations
- Light modulation effectively reduces external light interference
- Easy operation monitoring with bright LED indicator
- Cordsets with 2 m cable supplied for emitter and receiver
- Convert to PNP output with EE-2002 conversion connector
- Extend cabling up to 10 m

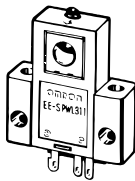

### Pre-Wired Photomicrosensors

Appearance	Sensor type	Sensing Distance	Dimensions H x W x D mm	Output form	Output type	Model
 (Receiver shown)	Through-beam	1 m	33.2 x 25.4 x 8.6	Light-ON	NPN	EE-SPW411
				Dark-ON		EE-SPW311

### Connector Cordsets (Cordsets Included with Sensor)

Appearance	Sensor type	Description	Dimensions H x W x D mm	Model
	Emitter cordset	2 m cable, 2 conductors	29 x 26 x 8	EE-1006L
	Receiver cordset	2 m cable, 3 conductors	16.2 x 11.8 x 5.3	EE-1006D

N

### Miniature Sensing Heads with In-Line Cable Amplifier

- 30 cm sensing distance with 2 mm diameter minimum object size
- Detect objects as small as 0.5 mm using slit pairs supplied
- Operation indicators allow monitoring from the amplifier housing or sensor head
- Models available with Light-ON or Dark-ON output configurations
- Light modulation effectively reduces external light interference
- Slim amplifier (12 H x 7.5 W x 50 D mm) with NPN output for easy handling and mounting
- Pre-wired with 2 m, 3-conductor cable for simple wiring
- 0.5 or 1 m sensing head-to-amplifier cable lengths available



### Pre-Wired Photomicrosensors

Appearance	Sensor type	Sensing distance	Dimensions H x W x D mm	Output form	Output type	Model
	Through-beam	30 cm	14 x 5.8 x 14, 0.5 m cable	Light-ON	NPN	EE-SPW421
			14 x 5.8 x 14, 1 m cable			EE-SPW421A
			14 x 5.8 x 14, 0.5 m cable	Dark-ON		EE-SPW321
			14 x 5.8 x 14, 0.5 m cable			EE-SPW321A

### Slit Sets

Reduce beam size to detect smaller objects more accurately by applying slits to the emitter and receiver. Two sizes included with the sensor.

Size of aperture	Sensing distance	Minimum object size
0.5 x 3 mm	10 cm	Opaque: 0.5 mm dia.
1 x 3 mm	20 cm	Opaque: 1 mm dia.

### Liquid Level Sensor with Built-In Amplifier

- Detect liquid level in manufacturing processes used in food & beverage and semiconductor industries
- Fits 6-13 mm diameter transparent or semi-transparent pipe with a wall thickness of 1 mm
- Easy to install tie-wrap and rubber tube provided to prevent slippage
- Incorporates a sensitivity selector, built-in amplifier, and operation mode selector
- Built-in amplifier with NPN output saves space and wiring effort
- Pre-wired with 1 m, talc-free cable, safe for use in clean room equipment

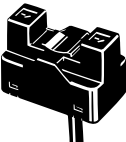

### Liquid Level Photomicrosensor

Appearance	Sensor type	Sensing Distance	Dimensions H x W x D mm	Output form	Output type	Model
	Through-beam (slot)	6-13 mm diameter pipes, as transparent as FEP	16 x 26 x 19	Light-ON/ Dark-ON selectable	NPN	EE-SPX613

# EE-SPZ-A

## Retro-reflective Photomicrosensors with Lens

Quick Link  
B438  
omron247.com

### Longer Sensing Distance, Simpler to Align Than Diffuse and Through-Beam Sensors

- Photomicrosensor with light modulation for reduced external light interference
- Easy adjustment and optical axis monitoring with a light indicator
- Wide operating voltage range: 5 to 24 VDC
- Supports connection with Programmable Controllers (PLCs)
- Easy-to-wire connectors assure easy maintenance

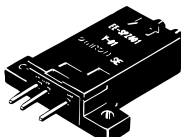

### Photomicrosensors

Appearance	Sensor type	Sensing distance	Output type	Output form	Model
	Retro-reflective type	200 mm	NPN output	Dark-ON	EE-SPZ301-A
				Light-ON	EE-SPZ401-A

### Accessories (Order Separately)

Type	Cable length	Model	Remarks
Connector	—	EE-1002	—
Connector with cable	1 m	EE-1003	—
NPN/PNP Conversion Connector	0.46 m (total length)	EE-2001	—
Connector Hold-Down Clip	—	EE-1003A	For EE-1003 only.
Reflector	—	E39-R1	—

# EE-SA701/EE-SA801

## Pushbutton-type Photomicrosensors

Quick Link

B439

omron247.com

### Pushbutton Actuator Accurately Detects Presence of Difficult-to-Detect Objects

- Conforms to semiconductor standards to enable accurate detection of FOUP cassettes without being affected by the material, color, or reflectance of the cassette bottoms. Thin design enables mounting in a wider range of applications, e.g., on transfer arms
- Increased visibility with 4-direction indicator
- Optical detection of actuator operation provides a long life (mechanical life: 5 million operations min.)
- Models with PNP or NPN output
- Models are available with very flexible robot cable



### Pushbutton Type Photomicrosensor

Appearance	Sensor distance	Sensing method	Operation mode	Cable length	Model	
					NPN output	PNP output
	0 to 3.5 mm (pressed position) (see note. 1)	Pushbutton	ON with no load	1 m	EE-SA801A 1M	EE-SA801R 1M
			OFF with no load	1 m (robot cable)	EE-SA801A-R 1M	EE-SA801R-R 1M
					EE-SA701-R- 1M	EE-SA701P-R 1M

Note: 1. Distance from the top surface of the housing to the top of the actuator.

# EE-SPY801/EE-SPY802

## Special Application Photomicrosensors

Quick Link  
B437  
omron247.com

### Wafer Carrier Position Sensor

- Unique optical system enables stable detection of almost all wafer-carriers
- Contact surfaces with the wafer carrier use a special chemical-resistant fluoro resin
- Set the mounting position using optional pedestals
- Light modulation effectively reduces external light interference
- Pre-wired with 2 m, talc-free cable, safe for use in clean room equipment

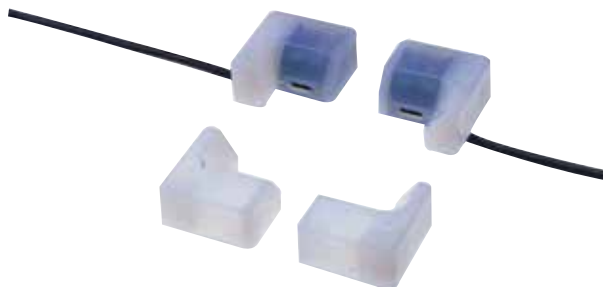

### Pre-Wired Photomicrosensors

Appearance	Sensor type	Sensing distance	Dimensions H x W x D mm	Output form	Output Type	Model
	Diffuse reflective	0-3 mm	15 x 32 x 30	Turns on when a wafer carrier is present	NPN	EE-SPY801
						EE-SPY802
	Pedestal (no sensor function)	—	15 x 32 x 30	Guides carrier for detection	—	EE9-C01
						EE9-C02

### Application

<p>Mount sensors to detect the support rails along the bottom of the wafer carrier.</p>	<p>Install a Sensor or Pedestal at each of the four corners indicated by a circle in the following diagram.</p>
<p>Points A and C Points B and D</p>	<p>EE-SPY801 or EE9-C01 EE-SPY802 or EE9-C02</p>



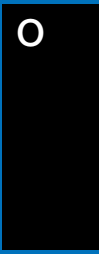

<b>Contents</b>		
Selection Guide		O-ii
<b>Limit Switches</b>		
WL-N	Robust single-pole/double break switches	O-2
D4A-N	Heavy-duty SPDT and DPDT switches, plug-in construction	O-3
D4C	Sealed, compact, slim pre-wired limit switch	O-4
D4CC	Sealed, compact, slim limit switch with connector	O-4
D4MC	Compact enclosed limit switch	O-5
D4E-N	Slim and compact enclosed limit switch with a long life	O-5
SHL	Enclosed limit switch with coil spring action	O-6
D5B	Tactile switches detect objects from multiple directions	O-7
VB	Multiple plunger limit switch	O-7
ZE/ZV/ ZV2	High-capacity switches, 3 mounting styles	O-8
<b>Basic Switches</b>		
Z	High precision basic switch	O-9
A	High capacity basic switch	O-10
X	Direct current basic switch	O-11
DZ	Basic switch with two independent circuits	O-12
TZ	High temperature basic switch	O-12

## DOWNSIZE WITHOUT COMPROMISE

### D4C – Compact, flat, high-performing switches





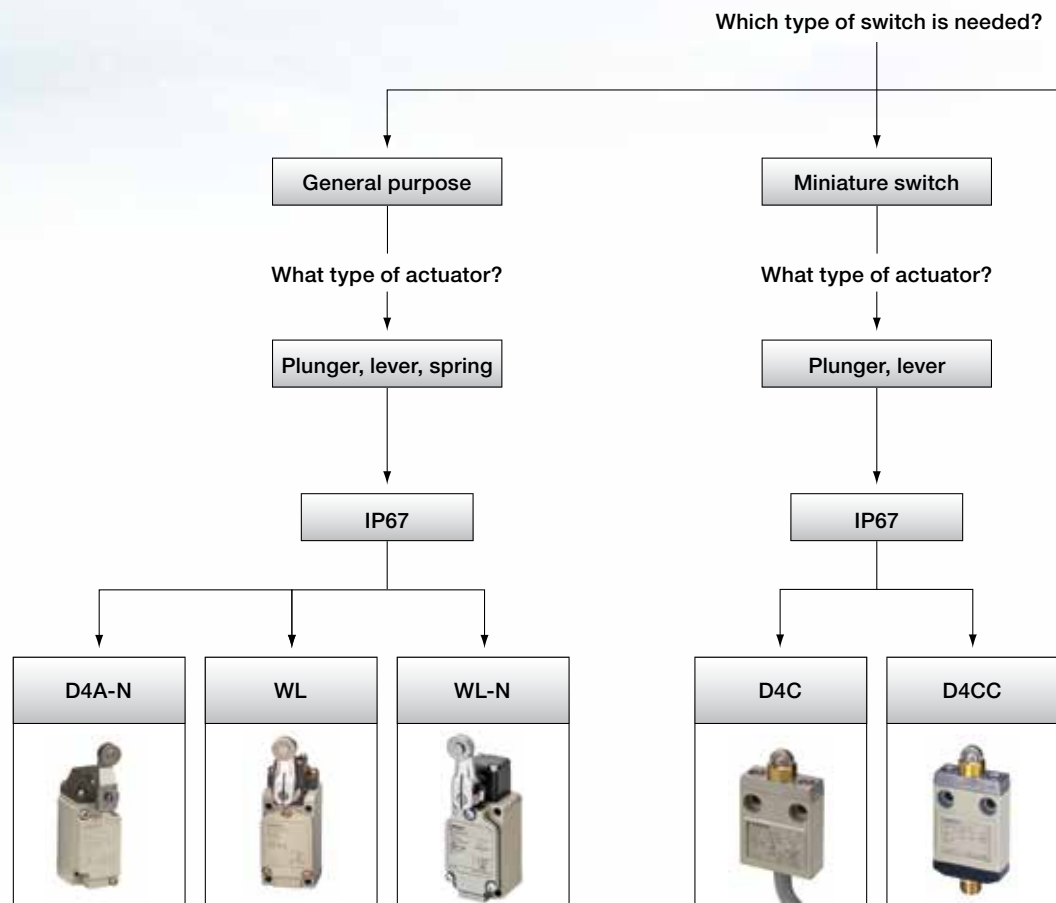

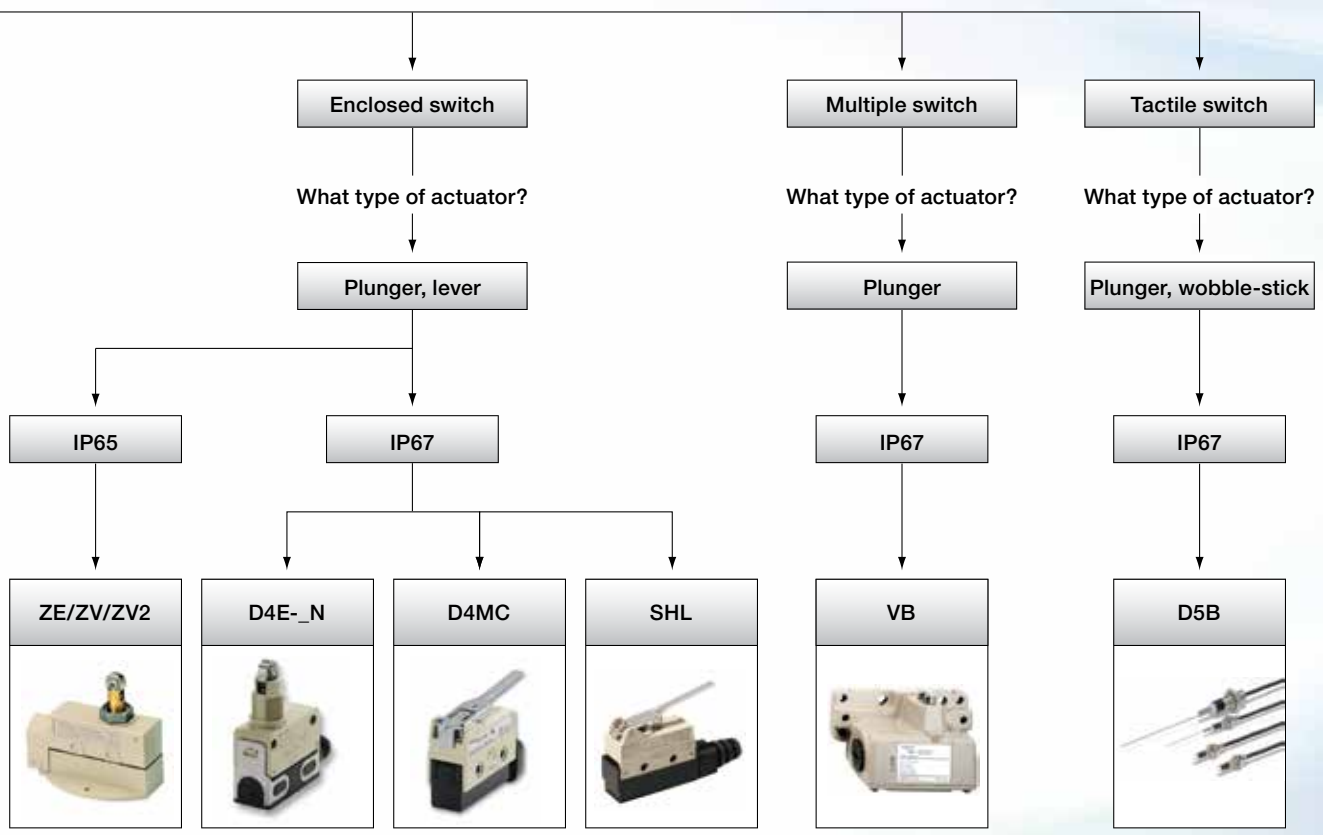





























With only a width of 16 mm, these compact and flat switches let you meet the demand for down-sizing without compromising on specifications. The reliable SPDT contact inside can switch up to 5 A/250 VAC resistive load. A full range of actuators is available to meet all your mechanical requirements.

- Slim, compact body sizes
- Wide range of actuators
- Strong metal housing, triple sealed with IP67 rating
- Pre-wired and quick-to-service connector models









# Selection Table

Type		Two circuit limit switch	Heavy duty limit switch	Enclosed switch, pre-wired	Enclosed switch, connector	High-capacity switch	
							
Selection criteria	Model	WL-N	D4A-N	D4C	D4CC	ZE/ZV/ZV2	
	Degree of protection	IP67	IP67	IP67	IP67	IP65	
	Contact type	SPDT	■	■	■	■	■
		DPDT	—	—	—	—	—
SPST-NC		—	—	—	—	—	
Switch ratings (Resistive load)		<ul style="list-style-type: none"> <li>• 10 A, 500 VAC</li> <li>• 6 A, 30 VDC</li> <li>• 0.8 A, 125 VDC</li> <li>• 0.4 A, 250 VDC</li> </ul>	<ul style="list-style-type: none"> <li>• 10 A, 480 VAC</li> <li>• 10 A, 14 VDC</li> <li>• 6 A, 30 VDC</li> <li>• 0.8 A, 125 VDC</li> </ul>	<ul style="list-style-type: none"> <li>• 5 A, 250 VAC</li> <li>• 4 A, 30 VDC</li> <li>• 0.4 A, 125 VDC</li> <li>• 0.2 A, 250 VDC</li> </ul>	<ul style="list-style-type: none"> <li>• 1 A, 125 VAC</li> <li>• 1 A, 30 VDC</li> </ul>	<ul style="list-style-type: none"> <li>• 15 A, 250 VAC</li> <li>• 10 A, 480 VAC</li> <li>• 10 A, 30 VDC</li> <li>• 0.5 A, 125 VDC</li> <li>• 0.25 A, 250 VDC</li> </ul>	
Features	Microload type	■	—	■	—	—	
	Operation indicator	■	■	■	■	—	
Actuators	Adjustable rod lever 	■	■	—	—	—	
	Adjustable roller lever 	■	■	—	—	—	
	Bevel plunger 	—	—	—	—	—	
	Center roller lever 	■	—	■	■	—	
	Coil spring 	■	■	—	—	—	
	Cross roller plunger 	■	—	■	■	■	
	Fork lever lock 	■	■	—	—	—	
	Hinge lever 	—	—	—	—	—	
	Hinge roller lever 	—	—	—	—	—	
	Horizontal roller plunger 	■	■	—	—	—	
	Horizontal ball plunger 	■	■	—	—	—	
	One-way action hinge roller lever 	—	—	—	—	■	
	Panel mount plunger 	—	—	—	—	—	
	Panel mount pin plunger 	—	—	—	—	—	
	Panel mount roller plunger 	—	—	—	—	—	
	Panel mount cross roller plunger 	—	—	—	—	—	
	Pin plunger 	■	—	■	■	—	
	Plastic rod 	■	—	■	■	—	
	Roller lever 	■	■	■	■	■	
	Roller plunger 	■	■	■	■	■	
	Sealed cross roller plunger 	■	—	■	■	■	
	Sealed plunger 	■	—	■	■	■	
	Sealed roller plunger 	■	—	■	■	■	
	Short hinge lever 	—	—	—	—	—	
	Short hinge roller lever 	—	—	—	—	—	
	Side plunger 	■	■	—	—	—	
	Side roller plunger 	■	■	—	—	—	
	Top ball plunger 	■	■	—	—	—	
	Top plunger 	■	■	—	—	—	
	Hemispherical ball 	—	—	—	—	—	
	Cone plunger 	—	—	—	—	—	
	Wire plunger 	—	—	—	—	—	

■ Standard    □ Available    — No/not available

# Limit Switches

Type			Small sealed switch	Enclosed switch	Coil spring action switch	Multiple plunger switch	Tactile switch
							
Selection criteria	Model		D4E- _N	D4MC	SHL	VB	D5B
	Degree of protection	IEC	IP67	IP67	IP67	IP67	IP67
	Contact type	SPDT	■	■	■	■	—
		DPDT	—	—	—	■ (Up to 6PDT)	—
SPST-NC		—	—	—	—	■	
Features	Switch ratings (Resistive load)		<ul style="list-style-type: none"> <li>• 5 A, 250 VAC</li> <li>• 5 A, 30 VDC</li> <li>• 0.5 A, 125 VDC</li> <li>• 0.25 A, 250 VDC</li> </ul>	<ul style="list-style-type: none"> <li>• 10 A, 250 VAC</li> <li>• 3 A, 480 VAC</li> <li>• 10 A, 14 VDC</li> <li>• 6 A, 30 VDC</li> <li>• 0.5 A, 125 VDC</li> <li>• 0.25 A, 250 VDC</li> </ul>	<ul style="list-style-type: none"> <li>• 10 A, 250 VAC</li> <li>• 2 A, 480 VAC</li> <li>• 10 A, 14 VDC</li> <li>• 0.4 A, 125 VDC</li> <li>• 0.2 A, 250 VDC</li> </ul>	<ul style="list-style-type: none"> <li>• 10 A, 250 VAC</li> <li>• 0.6 A, 125 VDC</li> <li>• 0.3 A, 250 VDC</li> </ul>	<ul style="list-style-type: none"> <li>• 1 mA, 5 VDC</li> <li>• 30 mA, 30 VDC</li> </ul>
	Microload type	■	—	■	■	■	■
Actuators	Operation indicator		■	—	■	—	—
	Adjustable rod lever	—	—	—	—	—	—
	Adjustable roller lever	—	—	—	—	—	—
	Bevel plunger	—	—	—	—	■	—
	Center roller lever	—	—	—	—	—	—
	Coil spring	—	—	—	—	—	—
	Cross roller plunger	■	—	—	—	—	—
	Fork lever lock	—	—	—	—	—	—
	Hinge lever	—	■	■	■	—	—
	Hinge roller lever	■	■	■	■	—	—
	Horizontal roller plunger	—	—	—	—	—	—
	Horizontal ball plunger	—	—	—	—	—	—
	One-way action hinge roller lever	■	—	—	■	—	—
	Panel mount plunger	■	■	■	■	—	—
	Panel mount pin plunger	—	—	—	—	—	—
	Panel mount roller plunger	■	■	■	■	—	—
	Panel mount cross roller plunger	■	■	■	■	—	—
	Pin plunger	—	—	—	—	—	—
	Plastic rod	—	—	—	—	—	—
	Roller lever	■	■	■	■	—	—
	Roller plunger	■	—	—	—	■	—
	Sealed cross roller plunger	■	—	—	—	—	—
	Sealed plunger	■	—	—	—	—	—
	Sealed roller plunger	■	—	—	—	—	—
	Short hinge lever	—	■	■	■	—	—
	Short hinge roller lever	—	■	■	■	—	—
	Side plunger	—	—	—	—	—	—
	Side roller plunger	—	—	—	—	—	—
	Top ball plunger	—	—	—	—	—	—
	Top plunger	—	—	—	—	—	—
	Hemispherical ball	—	—	—	—	—	■
	Cone plunger	—	—	—	—	—	■
	Wire plunger	—	—	—	—	—	■

■ Standard    □ Available    — No/not available

## GLOBAL STANDARD BASIC SWITCHES

Wide range offering the most standard basic switches

High precision and wide variety of styles meet wide range of applications.

- Long life, high-accuracy and high quality
- A large switching capacity of 15 A with high repeat accuracy
- Micro load models available
- Molded terminal-type models available

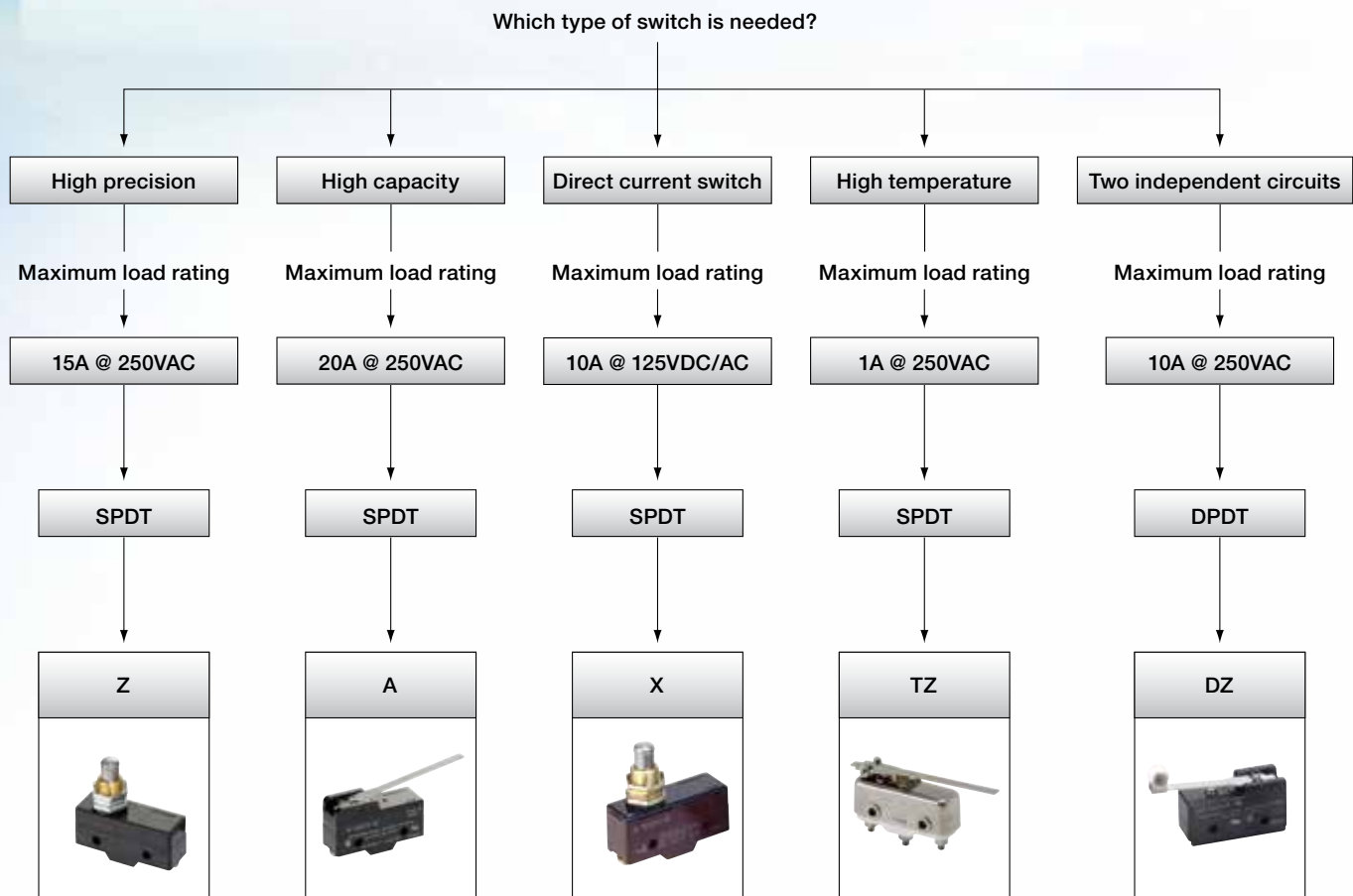

# Selection Table

Type		High precision switch	High capacity switch	Direct Current switch	High-temperature switch	Two independent circuits
						
Specifications	Model	Z-15G	A-20G	X-10G	TZ-1G	DZ-10G
	Contact type	SPDT ■	■	■	■	—
	DPDT	—	—	—	—	■
	Switch ratings (Resistive load)	<ul style="list-style-type: none"> <li>• 15A @ 250VAC</li> <li>• 6A @ 30VDC</li> <li>• 0.5A @ 125VDC</li> </ul>	<ul style="list-style-type: none"> <li>• 20A @ 250VAC</li> <li>• 6A @ 30VDC</li> <li>• 0.5A @ 125VDC</li> </ul>	<ul style="list-style-type: none"> <li>• 10A @ 125VDC/AC</li> <li>• 3A @ 250VDC/AC</li> </ul>	<ul style="list-style-type: none"> <li>• 1A @ 250VAC</li> <li>• 1A @ 30VDC</li> </ul>	<ul style="list-style-type: none"> <li>• 10A @ 250VAC</li> <li>• 0.5A @ 125VDC</li> </ul>
Service Life	Mechanical (cycles)	• 20 million	• 1 million	• 1 million	• 100,000	• 1 million
	Electrical (cycles)	• 500,000	• 500,000	• 100,000	• 50,000	• 500,000
Actuators	Pin plunger	■	■	■	■	■
	Slim spring plunger	□	—	□	—	—
	Short spring plunger	□	□	□	—	—
	Panel mount plunger	■	■	■	—	—
	Panel mount roller plunger	■	■	■	—	—
	Panel mount cross roller plunger	□	□	□	—	—
	Leaf spring lever	□	—	□	—	—
	Roller leaf spring lever	□	—	—	—	—
	Short hinge lever	□	□	□	—	—
	Hinge lever	■	■	■	■	■
	Low-force hinge lever	□	—	□	—	—
	Low-force wire hinge lever	□	—	—	—	—
	Short hinge roller lever	■	□	■	■	■
	Short hinge cross roller lever	□	—	—	—	—
	Hinge roller lever	□	■	□	■	■
	Hinge cross roller lever	□	—	—	—	—
	One-way short hinge roller lever	□	—	—	—	—
Reverse hinge lever	□	—	□	—	—	
Reverse short hinge roller lever	□	—	□	—	—	
Reverse hinge roller lever	□	—	□	—	—	

■ Standard    □ Available    — No/not available

## Robust Single-Pole/Double Break Switches with Built-In Actuators

- Rugged die-cast aluminum housing with high mechanical strength
- Rated IP67 with waterproof, oil-tight and dust-proof construction
- Easy to install and maintain
- Wide range of actuators:
  - Roller levers: Short, medium, long; flush mounting; flange mounting
  - Adjustable levers: Roller lever, rod lever
  - Fork roller levers
  - Plungers: Plain top, top roller, top ball, plain side, side roller, side ball
  - Wobble levers: Steel wire, nylon rod, coil spring
- Wide variety of standard, high-precision and overtravel models
- LED or neon lamp status indicator models available



## Specifications

- Load rating: 10 A max. at 125 VAC, NEMA A600
- Contact configuration: SPDT double break
- Mechanical life: 15 million operations
- High temperature, low temperature, corrosion proof, hermetic, anti-coolant, spatter resistant types available
- Micro-load and “Long-Life” types available
- Class 1 protection against electric shock
- Connection: 1/2-14 NPT conduit entrance, terminal screw connections
- Enclosure rating: IP67; NEMA 3, 4, and 13

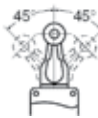
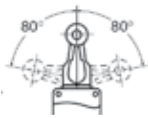
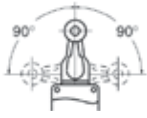
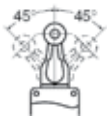
Type	Basic	High sensitivity overtravel	90-degree	High-precision overtravel
Action				
Features	<ul style="list-style-type: none"> <li>• Used with roller levers</li> </ul>	<ul style="list-style-type: none"> <li>• Operation is highly sensitive with only 10° pretravel</li> <li>• Overtravel is large, making setting the dog easier</li> <li>• Mounting is compatible with basic models</li> </ul>	<ul style="list-style-type: none"> <li>• Overtravel is large, making setting the dog easier</li> <li>• Mounting is compatible with basic models</li> </ul>	<ul style="list-style-type: none"> <li>• Repeat accuracy is twice that of basic models</li> <li>• Operation is highly sensitive with only 5° pretravel</li> <li>• Ideal for positioning, e.g., with machine tools</li> </ul>
One-way operation	Possible	Not possible	Not possible	Not possible
Head mounting	Any of 4 directions	Any of 4 directions	Any of 4 directions	Any of 4 directions



## Heavy-Duty SPDT and DPDT Switches with Plug-In Construction

- Oil-tight, watertight construction with double seal on the head, a complete gasket cover
- Plug-in construction reduces downtime for maintenance
- Convenient front mounting simplifies installation
- User-selectable operating direction for side rotary switches—CW, CCW, or both
- Position and lock the operating head at any of four 90° positions
- Wide operating temperature range: -40° to 100° C (side rotary)
- Side rotary switches accept a wide selection of levers
- DPDT, double-break models available for sequential operation and center neutral switching



## Specifications

- Load rating: SPDT double break: 10 A max. at 125 VAC, NEMA A600
  - DPDT double break: 5 A max. at 125 VAC, NEMA B600
- Mechanical life:
  - SPDT double break: 50 million operations
  - DPDT double break: 30 million operations
- Connection: 1/2-14 NPT conduit entrance, terminal screw connections
- Enclosure rating: IP67; UL NEMA 3, 4, 4X, 6P, 12 and 13
- Class I protection against electrical shock
- Wide range of actuators:
  - Roller lever: Standard, high-sensitivity, low torque, maintained, sequential operation, center neutral operation
  - Adjustable lever: Side plunger, top plunger
  - Wobble lever: Spring wire, plastic rod, cat whisker, coil spring

# D4C Enclosed Limit Switches

Quick Link  
L824  
omron247.com

## Sealed, Compact, Slim Pre-Wired Limit Switch

- Rugged die-cast aluminum housing
- Rated IP67; triple-sealed construction
- Designed for easy gang mounting
- Standard cable offers high flexibility, outstanding oil and extreme temperature resistance
- Wide range of actuators:

## Specifications

- Load rating: SPDT: 5 A max. at 250 VAC, NEMA B300
- Micro load versions available
- Enclosure rating: IP67; UL NEMA 3, 4 and 13
- Weather-resistant models available



# D4CC Enclosed Limit Switches

Quick Link  
L825  
omron247.com

## Sealed, Compact, Slim Limit Switch with Connector

- Center roller lever models enable ganged mounting of up to 6 switches
- M12 4-pin connector reduces installation and maintenance time
- Rated IP67; triple-sealed construction for plungers provides oil-tight and water-tight protection
- AC and DC switching models
- Wide range of actuators

## Specifications

- Load rating: SPDT, 1 A max. at 125 VAC, NEMA D150 or 1 A max. at 30 VDC
- Connection: M12 single keyway 4-pin connector
- Enclosure rating: IP67; UL NEMA 3, 4 and 13



## Compact Enclosed Limit Switch

- Suitable for applications demanding higher mechanical strength, dustproof and drip-proof properties
- Rated IP67; gasket diaphragm seal provides high environmental resistance
- High-precision and long life (10,000,000 mechanical operations)
- Wide range of actuators:
  - Panel mount plunger, roller plunger, cross roller plunger
  - Short and standard hinge lever
  - Standard, short and one-way action short hinge roller lever
- Screw terminals or pre-wired with 1 m cable



## Specifications

- Control output: SPDT (form C), rated 10 A max. at 125 VAC (inductive load)
- NEMA A300 rated
- Dimensions: 44.8 H x 21.7 W x 50 D mm (switch body with boot)

## Slim and Compact Enclosed Limit Switch with a Long Life

- Ideal for gang mounting
- Rated IP67; NEMA 3, 4 and 13
- Long service life (10,000,000 mechanical operations)
- Wide range of actuators:
  - Plunger, roller plunger, cross roller plunger
  - Sealed plunger, roller plunger, cross roller plunger
  - Standard and one-way action roller lever
- Screw terminals, connector or pre-wired with 1 m cable models
- Micro-load types available



## Specifications

- Control output: SPDT (form C), rated 5 A max. at 125 VAC (inductive load)
- NEMA A300 rated
- Dimensions: 32.9 H x 18 W x 43 D mm (switch body)

## Enclosed Limit Switch with Coil Spring Action

- Coil spring mechanism extends life of the switch
- Rated IP67; rigid zinc die-cast alloy housing
- Long service life (10,000,000 mechanical operations)
- Wide range of actuators:
  - Plunger panel mount plunger, roller plunger, cross roller plunger
  - Standard and short hinge lever
  - Standard and short hinge roller lever
  - One-way action standard and short hinge roller lever
- Screw terminals or pre-wired with cable models
- Molded terminal and indicator models available



## Specifications

- Control output: SPDT (form C), rated 10 A max. at 250 VAC (resistive load)
- Microload types rated 0.1 A at 125 VAC/30 VDC (resistive load)
- UL & NEMA A300 rated
- Dimensions: 32.9 H x 17.5 W x 45.6 D mm (switch body)

## Tactile Switches Detect Objects from Multiple Directions

- Detects object contact and operates even with a slight force
- Gold-plated contacts provide high contact reliability
- Switches micro current/voltage loads
- Long service life (10 million mechanical operations)
- Rated IP67 for resistance to dust, fine particles and water or oil splash
- Three sizes (M10, M8, and M5) to match total travel and operating force requirements
- Three actuator types: hemispheric, cone-shaped, and wobble-stick type
- Pre-wired with 1, 3 or 5 m cable



## Specifications

- Control output: Normally closed; 1 mA at 5 VDC to 30 mA max. at 30 VDC (resistive load)
- Dimensions: M5 x 24.5 L mm (hemispheric); 27 L mm (cone-shaped); 64.1 L mm (wobble stick)
- M8 x 28 L mm (hemispheric); 32.5 L mm (cone-shaped); 92.8 L mm (wobble stick)
- M10 x 33.3 L mm (hemispheric); 39.3 L mm (cone-shaped)
- 111.1 L mm (wobble stick)

# VB Limit Switches

## Multiple Plunger Limit Switch

- Multiple plunger switches are ideal for machine tools and sequential control
- Robust solution offers 2 to 6 switches in one enclosure
- Easy to install and service; switch box has an oil drain
- Rated IP67; rugged die-cast aluminum housing
- Ground terminal models have EN/IEC approval (CE marking)
- Long service life (5,000,000 mechanical operations)
- Roller plunger or bevel plunger actuators
- G1/2 conduit entrance; screw terminals



## Specifications

- Control output: SPDT (form C), rated 10 A max. at 125 VAC (resistive load)
- Microload types rated @ 0.1 A
- Dimensions: 68 H x 85 W x 58 D mm (2 switch model)
- 106 D mm (6 switch model)

## High-Capacity Switches

- Large 15 A, 125 VAC switching capacity and long service life
- Wide range of actuators:
  - Plunger: Pin, roller, cross roller
  - Roller arm lever: Standard and sealed
  - Sealed plunger: Pin, roller, cross roller
- Rugged die-cast aluminum housing
- Sealed switches rated IP65 (Z□-N)
- Three mounting styles available:
  - Side mounting (ZE)
  - Diagonal side mounting (ZV2) is ideal for gang mounting several switches
  - Flanged base mounting (ZV)



## Specifications

- Load rating: SPDT, 15 A max. at 125 VAC, NEMA B300 or 1 A max. at 30 VDC
- Mechanical life: 10 million operations
- Connection: Screw terminals on internal switch face forward when the cover is opened
- Enclosure rating: IP65 (ZE-N); IP60 (ZE-Q)
- Micro load version available

## Best-selling Basic Switch Boasting High Precision and Wide Variety

- Long life with high-accuracy and high quality
- A large switching capacity of 15 A with high repeat accuracy
- A wide range of variations in contact form available: basic, split-contact, and maintained-contact
- Micro load models available
- Molded terminal-type models incorporate a finger protection safety terminal cover



## Specifications

- Switch rating: 15 A, 250 VAC
- Contact form: SPDT
- Ambient operating temperature: -25°C to +80°C (with no icing)
- Ambient operating humidity: 35%RH to 85%RH
- Electrical operating frequency: 20 operations/minute maximum
- Electrical service life: 500,000 operations minimum

## Ordering Information

Actuator	Dimensions H x W x D mm	Rating	Contact form	Mounting hole size	Terminal type	Model
Pin plunger	30 X 49.2 X 17.45	15 A, 250 VAC 10 A, 500 VAC 0.5 A, 125 VDC 0.25 A, 250 VDC	SPDT	4.2 mm	Screw terminal Size : M4	Z-15G-B
					Screw terminal Size : #6-32NC	Z-15G-B7-K
Panel mount plunger	48.3 X 49.2 X 17.45				Screw terminal Size : M4	Z-15GQ-B
Panel mount roller plunger	62.3 X 49.2 X 17.45					Z-15GQ22-B
Hinge lever	38 X 49.2 X 17.45					Z-15GW-B
Short hinge roller lever	42.5 X 49.2 X 17.45					Z-15GW22-B

## High-capacity Switch Handles 20 A Loads with Large Inrush Currents

- Long life with high-accuracy and high quality
- Directly switches loads such as motors, halogen lamps and solenoids
- Same shape as Omron snap action switch model Z except pin plunger position, yet endures inrush currents as large as 75 A



## Specifications

- Switch Rating: 20 A, 250 VAC
- Contact form: SPDT
- Ambient operating temperature: -25°C to +80°C (with no icing)
- Ambient operating humidity: 35%RH to 85%RH
- Electrical operating frequency: 20 operations/minute maximum
- Electrical service life: 500,000 operations minimum

## Ordering Information

Actuator	Dimensions H x W x D mm	Rating	Contact form	Mounting hole size	Terminal type	Model
Pin plunger	30 X 49.2 X 17.45	20 A, 250 VAC 15 A, 500 VAC 0.5 A, 125 VDC 0.25 A, 250 VDC	SPDT	4.2 mm	Screw terminal Size : M4	A-20G-B
				3.56 mm	Screw terminal Size : #6-32NC	A-20G-B7-K
Panel mount plunger	48.3 X 49.2 X 17.45			4.2 mm	Screw terminal Size : M4	A-20GQ-B
Panel mount roller plunger	62.3 X 49.2 X 17.45					A-20GQ22-B
Hinge lever	49 X 49.2 X 17.45					A-20GV-B
Hinge roller lever	57 X 49.2 X 17.45					A-20GV2-B



## Direct Current Switch with Built-in Magnetic Blowout

- Can be used for either load rating of DC or AC for wide variety of applications
- Incorporates a small permanent magnet in the contact mechanism to deflect the arc to effectively extinguish it
- Ideal for switching DC circuits
- Wide variety of actuators for a wide scope of applications
- Same shape and mounting procedures as Omron's Model Z snap action switches.



## Specifications

- Switch Rating: 10 A, 125 VAC
- Contact form: SPDT
- Ambient operating temperature: -25°C to +80°C (with no icing)
- Ambient operating humidity: 35%RH to 85%RH
- Electrical operating frequency: 20 operations/minute maximum
- Electrical service life: 100,000 operations minimum

## Ordering Information

Actuator	Dimensions H x W x D mm	Rating	Contact form	Mounting hole size	Terminal type	Model
Pin plunger	30 X 49.2 X 17.45	10 A, 125 VDC/AC 3 A, 250 VDC/AC	SPDT	4.2	Screw terminal Size : M4	X-10G-B
Panel mount plunger	54 X 49.2 X 17.45					X-10GQ-B
Panel mount roller plunger	65 X 49.2 X 17.45					X-10GQ22-B
Hinge lever	49 X 49.2 X 17.45					X-10GW-B
Short hinge roller lever	52 X 49.2 X 17.45					X-10GW22-B

# DZ Series General-Purpose Basic Switches

Quick Link  
L866  
omron247.com

## DPDT Basic Switch for Two Independent Circuit Control

- Compact DPDT contacts for size restricted applications
- Incorporates two completely independent built-in switches
- Ideal for switching the circuits operating on two different voltages, and for controlling two independent circuits



## Specifications

- Ambient operating temperature: -25°C to +80°C (with no icing)
- Electrical service life: 500,000 operations minimum

## Ordering Information

Actuator	Dimensions H x W x D mm	Rating	Contact form	Mounting hole size	Terminal type	Model
Pin plunger	25.5 X 49.2 X 17.45	10 A, 250 VAC 10 A, 30 VDC 0.5 A, 125 VDC 0.25 A, 250 VDC	DPDT	4.2 mm	Screw terminal Size : M3	DZ-10G-1B
Hinge roller lever	41.6 X 49.2 X 17.45					DZ-10GV2-1B
Hinge lever	54.5 X 49.2 X 17.45					DZ-10GW-1B
Short hinge roller lever	47.9 X 49.2 X 17.45					DZ-10GW22-1B

# TZ Series General-Purpose Basic Switches

Quick Link  
L865  
omron247.com

## High-temperature Basic Switch for Extreme Applications

- Stable operation at an ambient temperature of 400°C
- Carefully chosen materials ensure high contact reliability at high ambient temperature



## Specifications

- Ambient operating temperature: -65°C to +400°C (with no icing)
- Electrical service life: 50,000 operations minimum

## Ordering Information

Actuator	Dimensions H x W x D mm	Rating	Contact form	Mounting hole size	Terminal type	Model
Pin plunger	25.5 X 49.2 X 17.45	1 A, 250 VAC 1 A, 30 VDC 0.4 A, 125 VDC	SPDT	3.56 mm	Screw terminal Size : M3.5	TZ-1G
Hinge lever	54.5 X 49.2 X 17.45					TZ-1GV
Short hinge roller lever	47.9 X 49.2 X 17.45					TZ-1GV22
Hinge roller lever	49 X 49.2 X 17.45					TZ-1GV2

## Contents

Selection Guide		P-ii
<b>Vision Sensors</b>		
FQ2	Compact vision sensor combining both camera and image processor within one unit, network up to 32 cameras with high image quality without complex operation	P-2
FQ-M	Compact vision sensor with motion tracking for pick-and-place robots	P-3
<b>Vision Systems</b>		
FZ5-L	Real Color Sensing, with over 100 processing items. Box Style 2 or 4 camera controllers. Ethernet, EtherNet/IP ready	P-3
FZ/FH Cameras	Wide camera selection for use with FZ and FH vision systems.	P-4
FH Vision Systems	Customizable vision system. Easier to embed in machines and shorter cycle times	P-6
<b>Accessories</b>		
FL	Lighting and Accessories	P-10
FL-V	Lighting and Accessories	P-10
3Z4S-LE	Lenses	P-13

## VISION SOLUTIONS: EASY AS TOUCH, COMMUNICATE & GO

LCD monitors allow for setup and immediate image visualization



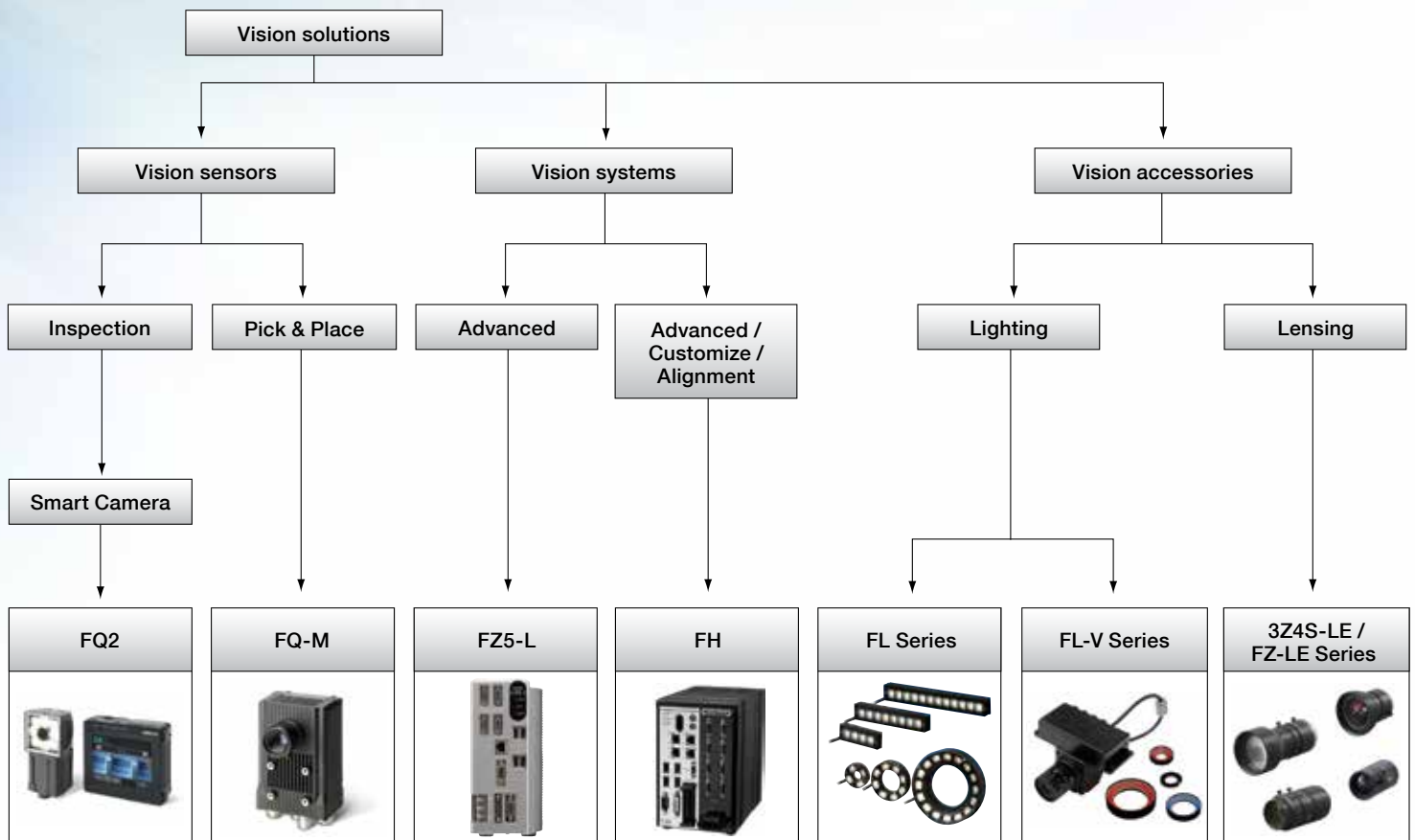

Vision sensors solve applications by intuitive teach and go procedures.

Advanced features of Vision systems allow for image processing, position correction and multiple inspections. Real Color Sensing allows for color inspection by discriminating up to 16.7 million colors. Intelligent Lighting and High Resolution Camera options allow for High-end image quality with both vision sensors and systems.

- Smart Vision – High Speed Inspections
- Vision Systems have data trending, logging and image storage for evaluation functions
- The New FQ offers unparalleled vision inspection
- Real color – close to human eye identification and image processing



# Selection Table

		Vision sensors		Vision systems	
					
Selection criteria	Model	FQ2	FQ-M	FZ5-L	FH
	Number of connectable cameras	32 connectable to 1 Touchfinder	2 connectable to 1 Touchfinder	4	8
	Camera type	Digital color and monochrome	Digital color and monochrome	FZ Cameras (Digital Color and monochrome)	FH and FZ Cameras (Digital Color and monochrome)
	Resolution (usable) Display dots	1280 x 1040	752 x 480	from 640 x 480 to 2448 x 2044	
	Number of storable configurations	8 (FQ-S1) 32 (FQ2-S2, S3, S4)	Up to 32	32 per Scene Group	
	Number of tools/configuration	1 (FQ-S1) 32 (FQ2-S2, S3, S4)	32	Limited only by memory space	
	IP-Rating camera head	IP67 ALL in one, IP40 C-mount	IP40	Depends on camera	
	Supply voltage	24 VDC	24 VDC	24 VDC	
Features	Image processing tools	FQ2-S1, S2, S3 Nine (Search, Shape search2, Sensitive search, Area, Color data, Edge position, Edge width, Labeling) FQ2-S4 THIRTEEN (9 + OCR, Bar code, 2D code, 2D code DPM)	Four (Shape search, Search, Labeling, Edge position)	Approx. 90 processing tools for object or defect recognition, measurements, calculations, input/output, display and more. Includes also character recognition and high precision edge code inspection tools	
	Image preprocessing	High-Dynamic Range (HDR), color gray filter, smoothing, dilate, erosion, median, extract edge, enhance edge, background suppression, polarizing filter, white balance	High-Dynamic Range (HDR), White balance	High Dynamic Range (HDR), smoothing, edge enhancement, edge extraction, erosion, dilation, median, background suppression - multiple passes, configurable	
	User interface	On board "teach & go" touch screen	On board "teach & go" touch screen	■	■
	Optional PC configuration software	■ (PC Tool Touchfinder)	■ (Sysmac Studio)	■ (Remote operation PC tool)	■ (Sysmac Studio, Remote operation PC tool)
	Security tools	■	■	■	■
Communication	RS-232C	□	–	■	■
	USB	–	–	■	■
	Ethernet	■	■	■ EtherNet/IP	■ EtherNet/IP
	EtherCAT	–	■	–	■
	Number of digital I/O	7 in/3 out	9 in/5 out	11 in/26 out	17 in/37 out

■ Standard    □ Available    – No/not available

P

## Clear Imaging Quality and Advanced Processing Tools in Easy to Use Interface

Achieve highly reliable inspection results on most challenging surfaces.

- Real Color Sensing – 16.7M Colors
- Integrated High-Power Lighting
- High-Dynamic-Range (HDR) Sensing
- Polarizing Filter Attachment



## Specifications

- Single function models: Offer 1 inspection and no position compensation
- Standard Models: Offer 32 inspections with Position Compensation

### 350,000 Pixel Sensors

Field of View (Horizontal x Vertical)	Installation Distance	Inspection Models		Inspection/ID/OCR Models			
		NPN Color	PNP Color	NPN Color	PNP Color	NPN Monochrome	PNP Monochrome
7.5x4.7 to 13x8.2 mm	38 to 60 mm	FQ2-S20010F	FQ2-S25010F	FQ2-S40010F	FQ2-S45010F	FQ2-S40010F-M	FQ2-S45010F-M
13x8.2 to 53x33 mm	56 to 215 mm	FQ2-S20050F	FQ2-S25050F	FQ2-S40050F	FQ2-S45050F	FQ2-S40050F-M	FQ2-S45050F-M
29x18 to 300x191 mm	32 to 380 mm	FQ2-S20100N	FQ2-S25100N	FQ2-S40100N	FQ2-S45100N	FQ2-S40100N-M	FQ2-S45100N-M
53x33 to 240x153 mm	220 to 970 mm	FQ2-S20100F	FQ2-S25100F	FQ2-S40100F	FQ2-S45100F	FQ2-S40100F-M	FQ2-S45100F-M

### 760,000 Pixel Sensors

Field of View (Horizontal x Vertical)	Installation Distance	Inspection/ID/OCR Models			
		NPN Color	PNP Color	NPN Monochrome	PNP Monochrome
7.5 x 6.7 to 13 x 11.6 mm	38 to 60 mm	FQ2-S40010F-08	FQ2-S45010F-08	FQ2-S40010F-08M	FQ2-S45010F-08M
13 x 11.6 to 53 x 47.3 mm	56 to 215 mm	FQ2-S40050F-08	FQ2-S45050F-08	FQ2-S40050F-08M	FQ2-S45050F-08M
29 x 25.9 to 300 x 268 mm	32 to 380 mm	FQ2-S40100N-08	FQ2-S45100N-08	FQ2-S40100N-08M	FQ2-S45100N-08M
53 x 47.3 to 240 x 214 mm	220 to 970 mm	FQ2-S40100F-08	FQ2-S45100F-08	FQ2-S40100F-08M	FQ2-S45100F-08M

### 1.3 Million Pixel Sensors

Field of View	Installation Distance	C-Mount (Inspection/ID/OCR) Type Models			
		NPN Color	PNP Color	NPN Monochrome	PNP Monochrome
Lens according to optical chart in datasheets		FQ2-S40-13	FQ2-S45-13	FQ2-S40-13M	FQ2-S45-13M

### Touch finder

Type	Model
DC power supply	FQ2-D30
AC/DC/Battery	FQ2-D31 (See Note.)

Note: AC adapter and battery are sold separately. Both accessories are required, see FQ brochure for details.

### Cables (Robotic cable)

Type	Cable length	Model
FQ Ethernet Cables (connect Sensor to Touch Finder, Sensor to PC)	2 m	FQ-WN002
	10 m	FQ-WN010
	20 m	FQ-WN020
I/O Cables	2 m	FQ-WD002
	10 m	FQ-WD010
	20 m	FQ-WD020

## Vision Designed for Motion Tracking with EtherCAT Communication Option

- Fast & precise positioning
- Encoder input for conveyor tracking and calibration
- Shape based object detection
- Smart calibration wizard
- Sysmac Studio software for vision system operation and setting



EtherCAT



## Visions Sensors

Appearance	Network type	Camera type	Output type	Model
	Ethernet data communication	Color	NPN	FQ-MS120
			PNP	FQ-MS125
		Monochrome	NPN	FQ-MS120-M
			PNP	FQ-MS125-M
	EtherCAT data communication	Color	NPN	FQ-MS120-ECT
			PNP	FQ-MS125-ECT
		Monochrome	NPN	FQ-MS120-M-ECT
			PNP	FQ-MS125-M-ECT

Notes: For lenses please refer to FZ-LE/3Z4S-LE models in Lighting and Accessories section.  
For Sysmac-Studio-User Vision License programming software, see page E-1.

## Touch Finder

Appearance	Description	Power supply	Model
	Optional touch screen setting and monitoring device for FQ-series sensors	DC power supply	FQ-MD30
		AC/DC battery*	FQ-MD31

\* AC Adapter and Battery are sold separately.

## Cables (robotic cable)

Type	Connectors	Cable length	Model
FQ Ethernet and EtherCAT Cables (connects Sensor to Touch Finder, Sensor to PC)	Angle M12 / Straight RJ45	5 m	FQ-MWNL005
		10 m	FQ-MWNL010
	Straight M12 / Straight RJ45	5 m	FQ-WN005
		10 m	FQ-WN010
FQ EtherCAT Cables	Angle M12 / Angle M12	5 m	FQ-MWNEL005
		10 m	FQ-MWNEL010
	Straight M12 / Straight M12	5 m	FQ-MWNE005
		10 m	FQ-MWNE010
I/O Cables	Angle	5 m	FQ-MWDL005
		10 m	FQ-MWDL010
	Straight	5 m	FQ-MWD005
		10 m	FQ-MWD010

## “Real Color” Vision Sensors Maximize Inspection Flexibility

- Mega ARCS Engine: High speed, stable color image processing for accurate inspections/ measurement close to human vision
- Controller tool set includes 1D bar code and 2D code reader and HDR function
- Wide range of cameras: 300K standard or high speed, pixel, 2- and 5-million pixel cameras
- Easy-to-use Windows-like GUI menu structure; simulation software offers testing, remote setting
- Communication interfaces: Digital, serial, Ethernet, EtherNet/IP



## System Configuration

### Box-type Light Controllers

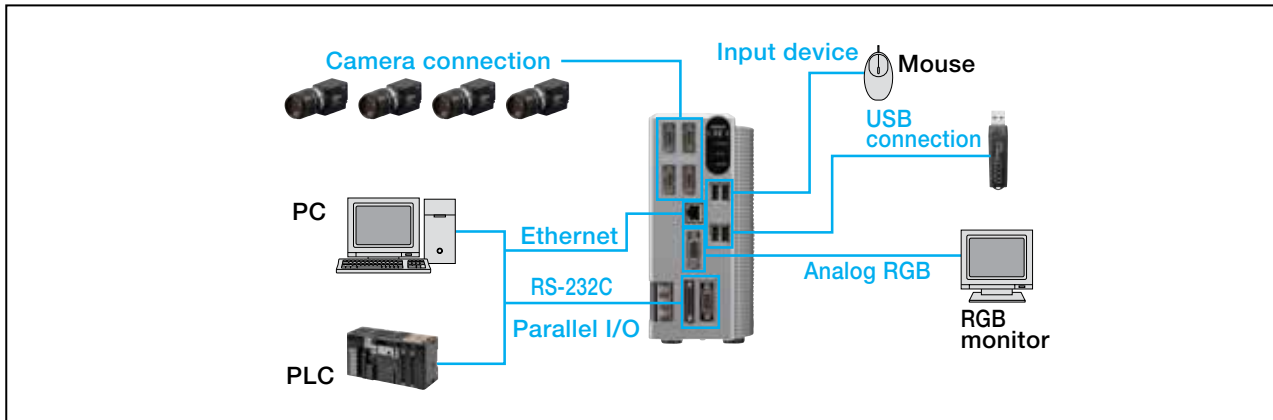

## Ordering Information

Type	Description	Number of cameras	Dimensions (mm)	NPN output model	PNP output model
Lite controllers	Box-type controllers	2	197 H x 80 W x 182.3 D	FZ5-L350	FZ5-L350-10
		4		FZ5-L355	FZ5-L355-10



## Cameras

5 million-pixel digital cameras



Color  
FZ-SC5M2

2 million-pixel digital cameras



Color  
FZ-SC2M

300,000-pixel digital cameras



Color  
FZ-SC

High Speed camera 300,000-pixel



Color  
FZ-SHC



Black & White  
FZ-S5M2



Black & White  
FZ-S2M



Black & White  
FZ-S



Black & White  
FZ-SH

Type	Description	Color	Features	Dimensions (mm)	Model
High-speed cameras	300,000 pixels	Mono	Lens required	35 H x 35 W x 48.2 D	FZ-SH
		Color			FZ-SHC
Digital cameras	300,000 pixels	Mono	Lens required	28 H x 28 W x 46.3 D	FZ-S
		Color			FZ-SC
	2 million pixels	Mono	Lens required	28 H x 28 W x 53.5 D	FZ-S2M
		Color			FZ-SC2M
	5 million pixels	Mono	Lens required	44 H x 44 W x 55 D	FZ-S5M2
		Color			FZ-SC5M2
Small, flat digital cameras	300,000 pixels	Mono	CCTV lens required	22 H x 34 W x 16.9 D	FZ-SF
		Color			FZ-SFC
Small, pen type digital cameras	300,000 pixels	Mono	CCTV lens required	M10.5 dia. x 44 L	FZ-SP
		Color			FZ-SPC

Note: For lenses please reference FZ-LE/3Z4S-LE models in Lighting and Accessories section.

## Intelligent Compact Cameras

The compact unit contains both camera and smart lighting.









Type	Description	Color	Features	Dimensions (mm)	Model
Intelligent compact cameras	Wide view (short-distance)	Color	Camera + Lens + Intelligent lighting	46 H x 49 W x 94.8 D	FZ-SQ100N
	Wide view (long-distance)	Color			FZ-SQ100F
	Standard view	Color		46 H x 57 W x 94.8 D	FZ-SQ050F
	Narrow view	Color			FZ-SQ010F

## Strobe Controllers

Application	Channels	Source	Model
Required to control external lighting from FZ5 controller	1	For FL-Series lights	FL-TCC1
	1	For FLV-Series lights	FLV-TCC1
	4	For FLV-Series lights	FLV-TCC4





## Cables

Item	Description	Model
	Camera Cable Cable length: 2 m, 3 m, 5 m, or 10 m *2	FZ-VS3
	Bend resistant Camera Cable Cable length: 2 m, 3 m, 5 m, or 10 m *2	FZ-VSB3
	Right-angle Camera Cable *1 Cable length: 2 m, 3 m, 5 m, or 10 m *2	FZ-VSL3
	Bend resistant Right-angle Camera Cable Cable length: 2 m, 3 m, 5 m, or 10 m *2	FZ-VSLB3
	Long-distance Camera Cable Cable length: 15 m *2	FZ-VS4
	Long-distance Right-angle Camera Cable *1 Cable length: 15 m *2	FZ-VSL4
	Cable Extension Unit Up to two Extension Units and three Cables can be connected. (Maximum cable length: 45 m *2)	FZ-VSJ

\*1 This Cable has an L-shaped connector on the Camera end.

\*2 The maximum cable length depends on the Camera being connected, and the model and length of the Cable being used. For further information, please refer to the "Cameras / Cables Connection" table and "Maximum Extension Length Using Cable Extension Units FZ-VSJ table." When a high-speed CMOS camera FH-S□02/-S□04/-S□12 is used in the high speed mode of transmission speed, two camera cables are required.

## Parallel I/O Cables/Encoder Cables

Item	Description	Model
	Parallel I/O Cable *1 Cable length: 2 m or 5 m	XW2Z-S013-□ *2
	Parallel I/O Cable for Connector-terminal Conversion Unit *1 Cable length: 0.5 m, 1 m, 1.5 m, 2 m, 3 m, 5 m; Connector-Terminal Block Conversion Units can be connected (Terminal Blocks Recommended Products: OMRON XW2R- 34G-T)	XW2Z-□□□EE*3
	Connector-Terminal Block Conversion Units, General-purpose devices	XW2R-□34G-T *4
	Encoder Cable for line-driver Cable length: 1.5 m	FH-VR









\*1 2 Cables are required for all I/O signals.

\*2 Insert the cables length into □ in the model number as follows. 2 m = 2, 5 m = 5

\*3 Insert the cables length into □□□ in the model number as follows. 0.5 m = 050, 1 m = 100, 1.5 m = 150, 2 m = 200, 3 m = 300, 5 m = 500

\*4 Insert the wiring method into □ in the model number as follows. Phillips screw = J, Slotted screw (rise up) = E, Push-in spring = P  
Refer to the XW2R Series catalog (Cat. No. G077) for details.

## Accessories

Item	Description	Model		
	LCD Monitor 8.4 inches For Box-type Controllers*1	FZ-M08		
	LED Monitor Cable: Cable length: 2 m or 5 m (When you connect a LCD Monitor FZ-M08 to FH sensor controller, please use it in combination with a DVI-I -RGB Conversion Connector FH-VMRGB.)	FZ-VM		
	DVI-I -RGB Conversion Connector	FH-VMRGB		
	USB Memory	2 GB	FZ-MEM2G	
		8 GB	FZ-MEM8G	
	SD Card	2 GB	HMC-SD291	
		4 GB	HMC-SD491	
	Display/USB Switcher	FZ-DU		
—	Mouse Recommended Products: Driverless wired mouse (A mouse that requires the mouse driver to be installed is not supported.)	—		
	EtherCAT junction slaves	3 port	Power supply voltage: 20.4 to 28.8 VDC Current consumption: 0.08 A	GX-JC03
		6 port	(24 VDC -15 to 20%) Current consumption: 0.17 A	GX-JC06
	Industrial Switching Hubs for EtherNet/IP and Ethernet	3 port	Failure detection: None Current consumption: 0.08 A	W4S1-03B
		5 port	Failure detection: None Current consumption: 0.12 A	W4S1-05B
		5 port	Failure detection: Supported	W4S1-05C
—	Calibration Plate	FZD-CAL		
—	External Lighting		FLV Series *2	
			FL Series *2	

\*1 It can be used in FH series.

\*2 Refer to the Vision Accessory Catalog (Cat. No. Q198) for details.

## Easier to Embed in Machines, Shorter Machine Cycle Times

- Calculations are easy to set for the results from four parallel tasks.
- Synchronous control of devices connected via EtherCAT is possible.
- The new Shape Search III processing item enables fast, precise and stable measurements.
- Microsoft .NET is supported to share machine interface with PC.
- User interface customization is supported.



P

## System Configuration

### EtherCAT connections for FH series

Example of the FH Sensor Controllers (4-camera type)

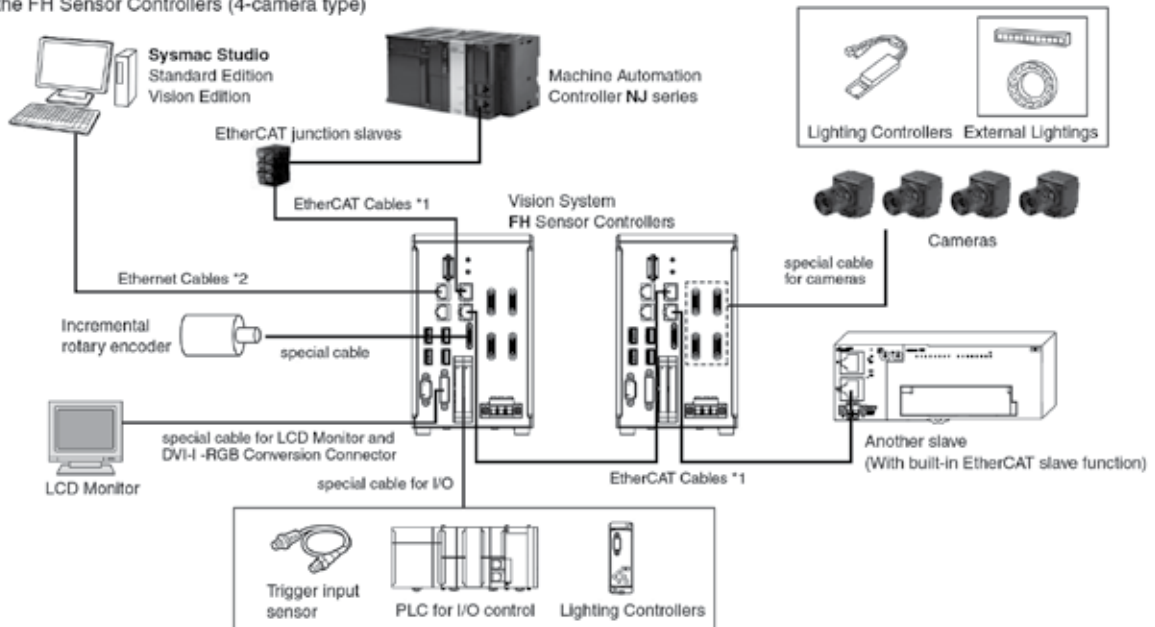

\*1. To use STP (shielded twisted-pair) cable of category 5 or higher with double shielding (braiding and aluminum foil tape) for EtherCAT and RJ45 connector.  
\*2. To use STP (shielded twisted-pair) cable of category 5 or higher for Ethernet and RJ45 connector.

## Controllers

Item	CPU	No. of Cameras	Output	Model
	High-speed Controllers (4 core)	2	NPN/PNP	FH-3050
		4	NPN/PNP	FH-3050-10
		8	NPN/PNP	FH-3050-20
	High-speed Controllers (2 core)	2	NPN/PNP	FH-1050
		4	NPN/PNP	FH-1050-10
		8	NPN/PNP	FH-1050-20

## Development Environment

Type	System requirements	Number of Model Standards Licenses	Media	Model
Application Producer	Software components that provide a development environment to further customize the standard controller features of the FH Series. System requirements: <ul style="list-style-type: none"> <li>• CPU: Intel Pentium Processor (SSE2 or higher)</li> <li>• OS: Windows 7 Professional (32-bit) or Enterprise (32-bit) or Ultimate (32-bit)</li> <li>• .NET Framework: .NET Framework 3.5 or higher</li> <li>• Memory: At least 2 GB RAM</li> <li>• Available disk space: At least 2 GB</li> <li>• Browser: Microsoft® Internet Explorer 6.0 or later</li> <li>• Display: XGA (1024 x 768), True Color (32-bit) or higher</li> <li>• Optical drive: CD/DVD drive</li> </ul> The following software is required to customize the software: Microsoft® Visual Studio® 2010 Professional or Microsoft® Visual Studio® 2008 Professional	- (Media only)	CD	FH-AP1
		1 license	-	FH-AP1L



Note: For Sysmac-Studio-User Vision License programming software, see page E-1.

## Touch Panel Monitor

Item	Descriptions	Model
	Touch Panel Monitor 12.1 inches For FH Sensor Controllers*	FH-MT12

\* FH Series Sensor Controllers version 5.32 or higher is required.

## Touch Panel Monitor Cables

Item	Descriptions	Model
	DVI-Analog Conversion Cable for Touch Panel Monitor Cable length: 2 m, 5 m or 10 m	FH-VMDA
	RS-232C Cable for Touch Panel Monitor Cable length: 2 m, 5 m or 10 m	XW2Z-□□□PP-1*
	USB Cable for Touch Panel Monitor Cable length: 2 m or 5 m	FH-VUAB

\* Insert the cables length into □□□ in the model number as follows: 2 m = 200, 5 m = 500, 10 m = 010

## Cameras

12 million-pixel  
High Speed CMOS Cameras



Color  
FH-SC12



Monochrome  
FH-SM12

4 million-pixel  
High Speed CMOS Cameras



Color  
FH-SC04



Monochrome  
FH-SM04

2 million-pixel  
High Speed CMOS Cameras



Color  
FH-SC02



Monochrome  
FH-SM02

300,000-pixel  
High Speed CMOS Cameras



Color  
FH-SC



Monochrome  
FH-SM

Type	Description	Color	Frame Rate	Dimensions (mm)	Model
High-speed CMOS cameras	12 Mega-pixel	Color	25.7 ms *	68 H x 68 W x 45 D	FH-SC12
		Monochrome			FH-SM12
	4 Mega-pixel	Color	8.5 ms *	40 H x 40 W x 48.7 D	FH-SC04
		Monochrome			FH-SM04
	2 Mega-pixel	Color	4.6 ms *		FH-SC02
		Monochrome			FH-SM02
	300,000 pixel	Color	3.3 ms	40 H x 40 W x 46.2 D	FH-SC
		Monochrome			FH-SM

Note: These cameras are for FH controllers only.

For lenses, please reference 3Z4S-LE models in Lighting and Accessories section.

For camera cables and existing FZ cameras that can be connected to FH series controller, please reference FZ/FH Camera and Vision System Accessories section.

\* Frame rate in high speed mode when the camera is connected using two camera cables.  
For other conditions, please refer to FH Brochure.

P



## Bar Lighting

Appearance	Light color	Description	Size (mm)	Model
	White LEDs	Wide area model	20 H x 49.8 W x 20 D	FL-BR5020W
		High-brightness model		FL-BR5020W-H
		Wide area model	20 H x 90.6 W x 20 D	FL-BR9120W
		High-brightness model		FL-BR9120W-H
		Wide area model	20 H x 131.4 W x 20 D	FL-BR13120W
		High-brightness model		FL-BR13120W-H

## Direct Ring Lighting

Appearance	Light color	Description	Size (mm)	Model
	White LEDs	Wide area model	20 H x 90 W x 90 D	FL-DR90W
		High-brightness model		FL-DR90W-H

## FL Lighting Controllers

Appearance	Description	Input voltage	Size (mm)	I/O specifications	Model
	One-channel models	24 VDC	98 H x 22.5 W x 64.9 D	NPN	FL-STC10
	Two-channel models			PNP	FL-STC15
				NPN	FL-STC20
	PNP			FL-STC25	
	One-channel	—	—	FZ camera interface module	FL-TCC1

## Extension Cable Standard

Cable length	Weight	Model
1 m	Approx. 50 g	FL-XC1
2 m	Approx. 80 g	FL-XC2
3 m	Approx. 120 g	FL-XC3
5 m	Approx. 190 g	FL-XC5
10 m	Approx. 400 g	FL-XC10
25 m	Approx. 1000 g	FL-XC25

## Extension Cable Flexible

Cable length	Weight	Model
1 m	Approx. 60 g	FL-XC1R
2 m	Approx. 100 g	FL-XC2R
3 m	Approx. 150 g	FL-XC3R
5 m	Approx. 240 g	FL-XC5R
10 m	Approx. 600 g	FL-XC10R
25 m	Approx. 1200 g	FL-XC25R

## Parallel Cable

Cable length	Weight	Model
2 m	Approx. 180 g	FL-XCP2



## Diffusion Plates

Description	Dimensions (mm)	Weight	Model
Bar lighting	49.8 W x 18 H x 4 D	Approx. 5 g	FL-BR5020DF
	90.6 W x 18 H x 4 D	Approx. 10 g	FL-BR9120DF
	131.4 W x 18 H x 4 D	Approx. 15 g	FL-BR13120DF

Description	Outer diameter/ Inner diameter/Thickness (mm)	Model
Direct ring lighting	90 OD/50 ID/4 t	FL-DR90DF

## Polarization Plate

Description	Outer diameter/Inner diameter/Thickness (mm)	Model
Direct ring lighting	90 OD/50 ID x 2 t	FL-DR90PL



## Lighting

Description	Model	Models	Light Color
Direct Ring Lighting	FLV-DR Series	34 Models	White/Red/Blue/Infrared/Ultraviolet
Low Angle Ring Lighting	FLV-DL Series	15 Models	White/Red/Blue
Bar Lighting	FLV-BR Series	32 Models	White/Red/Blue/Infrared/Ultraviolet
Coaxial Lighting	FLV-CL Series	17 Models	White/Red/Blue/Infrared/Ultraviolet
Shadowless Lighting	FLV-FS Series	3 Models	White/Red/Blue
	FLV-FR Series	6 Models	White/Red/Blue
	FLV-FQ Series	3 Models	White/Red/Blue
Direct Back Lighting	FLV-DB Series	12 Models	White/Red/Blue
Edge Type Lighting	FLV-FB Series	15 Models	White/Red/Blue
Edge Type Coaxial Lighting	FLV-FX Series	6 Models	White/Red/Blue
Dome Lighting	FLV-DD Series	9 Models	White/Red/Blue
High Power Spot Lighting	FLV-EP8 Series	3 Models	White/Red/Blue
Spot Lighting	FLV-EP50 Series	2 Models	White/Red

Note: For more details, reference FLV Brochure.

## Camera Mount Lighting Controllers

Model	Number of Connectable Lighting	Applicable Lighting		Power Supply Voltage	Electricity of Connectable Lighting	Luminance Control Method
		Standard Lighting FLV Series *1	Spot Lighting FLV-EP Series			
FLV-TCC1	1 ch	■	—	24 VDC *2	15W max.	Digital *3
FLV-TCC4	4 ch	■	—			

\*1. Standard lighting is all FLV-series Lightings excluding the FLV-EP-series Spot Lightings.

\*2. If the total power consumption of Lightings is 7.5 W or less, an external power supply is not required because the power is supplied from the Camera.

\*3. Luminance can be controlled by setting from the Vision Sensor Controller.

## Digital Lighting Controllers

Applicable Lighting	Model	Number of Connectable Lights	Power Supply Voltage	Electricity of Connectable Light	Luminance Control Method
FLV	3Z4S-LT IDGB-50M2-L01	2 ch	24 VDC	46W max.	Digital
	3Z4S-LT IDGB-150M4-L01	4 ch		144W max.	

\*1. Standard lighting is all FLV-series Lightings excluding the FLV-EP-series Spot Lightings.

## Cables for Light Controller

Cable Type	Model	Length Options
ON/OFF	3Z4S-LT IC-MIL-20-□	1 m, 2 m, 3 m, 5 m, 10 m
Control	3Z4S-LT IC-MIL-26-□	

## Cables

Description	Model	Sizes
Extension Cable for Standard Lighting *1	FLV-XC1	1 m
	FLV-XC2	2 m
	FLV-XC3	3 m
	FLV-XC5	5 m
Extension Cable for Spot Lighting	FLV-XC1EP	1 m
	FLV-XC2EP	2 m
	FLV-XC3EP	3 m
	FLV-XC5EP	5 m
Branch Cable for Standard Lighting *1	FLV-XC1S2	1 m
	FLV-XC2S2	2 m
	FLV-XC3S2	3 m
	FLV-XC5S2	5 m

\*1. Standard lighting is all FLV-series Lightings excluding the FLV-EP-series Spot Lightings.

## Diffusion Plates

Description	Model	Connectable Lighting
Direct Ring Lighting	FLV-DR1203ODF	Direct Right Lighting FLV-DR1203O□
	FLV-DR9215DF	Direct Right Lighting FLV-DR9215□
	FLV-DR9303DF	Direct Right Lighting FLV-DR9303□
	FLV-DR9000DF	Direct Right Lighting FLV-DR9000□
	FLV-DR7000DF	Direct Right Lighting FLV-DR7000□
	FLV-DR7030DF	Direct Right Lighting FLV-DR7030□
	FLV-DR6615DF	Direct Right Lighting FLV-DR6615□
	FLV-DR5030DF	Direct Right Lighting FLV-DR5030□
	FLV-DR3220DF	Direct Right Lighting FLV-DR3220□
Bar Lighting	FLV-BR48031DF	Direct Right Lighting FLV-BR48031□
	FLV-BR38037DF	Bar Lighting FLV-BR38037□
	FLV-BR21230DF	Bar Lighting FLV-BR21230□
	FLV-BR21222DF	Bar Lighting FLV-BR21222□
	FLV-BR15020DF	Bar Lighting FLV-BR15020□
	FLV-BR14030DF	Bar Lighting FLV-BR14030□
	FLV-BR11222DF	Bar Lighting FLV-BR11222□
	FLV-BR8532DF	Bar Lighting FLV-BR8532□
	FLV-BR6022DF	Bar Lighting FLV-BR6022□
Low Angle Ring Lighting	FLV-DL15060DF	Low Angle Ring Lighting FLV-DL15060□
	FLV-DL12060DF	Low Angle Ring Lighting FLV-DL12060□
	FLV-DL7260DF	Low Angle Ring Lighting FLV-DL7260□
	FLV-DL5890DF	Low Angle Ring Lighting FLV-DL5890□



## C-mount lenses (Recommended: FH-S□ / FZ-S□ / FZ-SH□)

Model	3Z4S-LE SV-0614V	3Z4S-LE SV-0813V	3Z4S-LE SV-1214V	3Z4S-LE SV-1614V	3Z4S-LE SV-2514V	3Z4S-LE SV-3518V	3Z4S-LE SV-5018V	3Z4S-LE SV-7527V	3Z4S-LE SV-10035V
Appearance									
Focal length	6mm	8mm	12mm	16mm	25mm	35mm	50mm	75mm	100mm
Brightness	F1.4	F1.3	F1.4	F1.4	F1.4	F1.8	F1.8	F2.7	F3.5
Filter size	M27 P0.5	M25.5 P0.5	M27 P0.5	M27 P0.5	M27 P0.5	M27 P0.5	M30.5 P0.5	M30.5 P0.5	M30.5 P0.5







## High resolution, low distortion lenses (Recommended: FZ-S□2M / FZ-S□5M2)

Model	3Z4S-LE SV-0614H	3Z4S-LE SV-0814H	3Z4S-LE SV-1214H	3Z4S-LE SV-1614H	3Z4S-LE SV-2514H	3Z4S-LE SV-3514H	3Z4S-LE SV-5014H	3Z4S-LESV-7525H	3Z4S-LESV-10028H
Appearance									
Focal length	6mm	8mm	12mm	16mm	25mm	35mm	50mm	75mm	100mm
Brightness	F1.4	F1.4	F1.4	F1.4	F1.4	F1.4	F1.4	F2.5	F2.8
Filter size	M40.5 P0.5	M35.5 P0.5	M27.0 P0.5	M27.0 P0.5	M27.0 P0.5	M35.5 P0.5	M40.5 P0.5	M34.0 P0.5	M40.5 P0.5





## High resolution, low distortion lenses (Recommended: FH-S□02 / FH-S□04)

C-mount Lens for 1-inch image sensor

(3Z4S-LE SV-7525H with focal length of 75 mm and 3Z4S-LE SV-10028H with focal length of 100 mm are also available.)

Model	3Z4S-LE VS-0618H1	3Z4S-LE VS-0814H1	3Z4S-LE VS-1214H1	3Z4S-LE VS-1614H1N	3Z4S-LE VS-2514H1	3Z4S-LE VS-3514H1	3Z4S-LE VS-5018H1
Appearance/ Dimensions (mm)							
Focal length	6 mm	8 mm	12 mm	16 mm	25 mm	35 mm	50 mm
Aperture (F No.)	1.8 to 16	1.4 to 16	1.4 to 16	1.4 to 16	1.4 to 16	1.4 to 16	1.4 to 16
Filter size	Can not be used a filter	M55.0 P0.75	M35.5 P0.5	M30.5 P0.5	M30.5 P0.5	M30.5 P0.5	M40.5 P0.5

## M42-mount Lens for large image sensor (Recommended: FH-S□12)

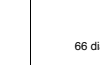
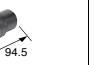
Model	3Z4S-LE VS-L1828/M42-10	3Z4S-LE VS-L2526/M42-10	3Z4S-LE VS-L3528/M42-10	3Z4S-LE VS-L5028/M42-10	3Z4S-LE VS-L8540/M42-10	3Z4S-LE VS-L10028/M42-10
Appearance/ Dimensions (mm)						
Focal length	18 mm	25 mm	35 mm	50 mm	85 mm	100 mm
Aperture (F No.)	2.8 to 16	2.6 to 16	2.8 to 16	2.8 to 16	4.0 to 16	2.8 to 16
Filter size	M55.0 P0.75	M55.0 P0.75	M62.0 P0.75	M62.0 P0.75	M52.0 P0.75	M52.0 P0.75
Maximum sensor size	1.8 inch					
Mount	M42 mount					

## Lenses for small cameras

Model	FZ-LES3	FZ-LES6	FZ-LES16	FZ-LES30
Appearance				
Focal length	3mm	6mm	16mm	30mm
Brightness	F2.0	F2.0	F3.4	F3.4

## Extension tubes

Applicable cameras	Sizes	Outer Diam.	Model
Standard Cameras	Set of 7: 40, 20, 10, 5, 2, 1, 0.5 mm	30 mm max.	3Z4S-LE SV-EXR
Small Cameras	Set of 3: 15, 10, 5 mm	12 mm max.	FZ-LESR



<b>Contents</b>		
Selection Guide		Q-ii
<b>Laser Displacement</b>		
ZX1	CMOS laser displacement sensors with built-in amplifier, long distance models	Q-1
ZX2	CMOS laser displacement sensors for stable measurement	Q-2
ZX-L-N	Laser measurement sensors, smart amplifier	Q-3
ZS-L	Scalable precision laser measurement sensor	Q-4
ZS-HL	Scalable high-precision and long distance measurement sensor	Q-5
<b>Inductive Displacement</b>		
ZX-E	Inductive displacement sensors, smart amplifier	Q-6
<b>Contact Displacement</b>		
ZX-T	Contact displacement sensors, smart amplifier	Q-7
<b>Confocal Displacement</b>		
ZW	Confocal fiber displacement sensor	Q-8
<b>Width-Measuring</b>		
ZX-GT	Wide laser measurement sensors, smart amplifier	Q-9
<b>Laser 2D Profile</b>		
ZG2	2D measurement sensor	Q-10



## HIGH-PRECISION QUALITY INSPECTION

### Zero defect becomes reality—scalable accuracy in inspection



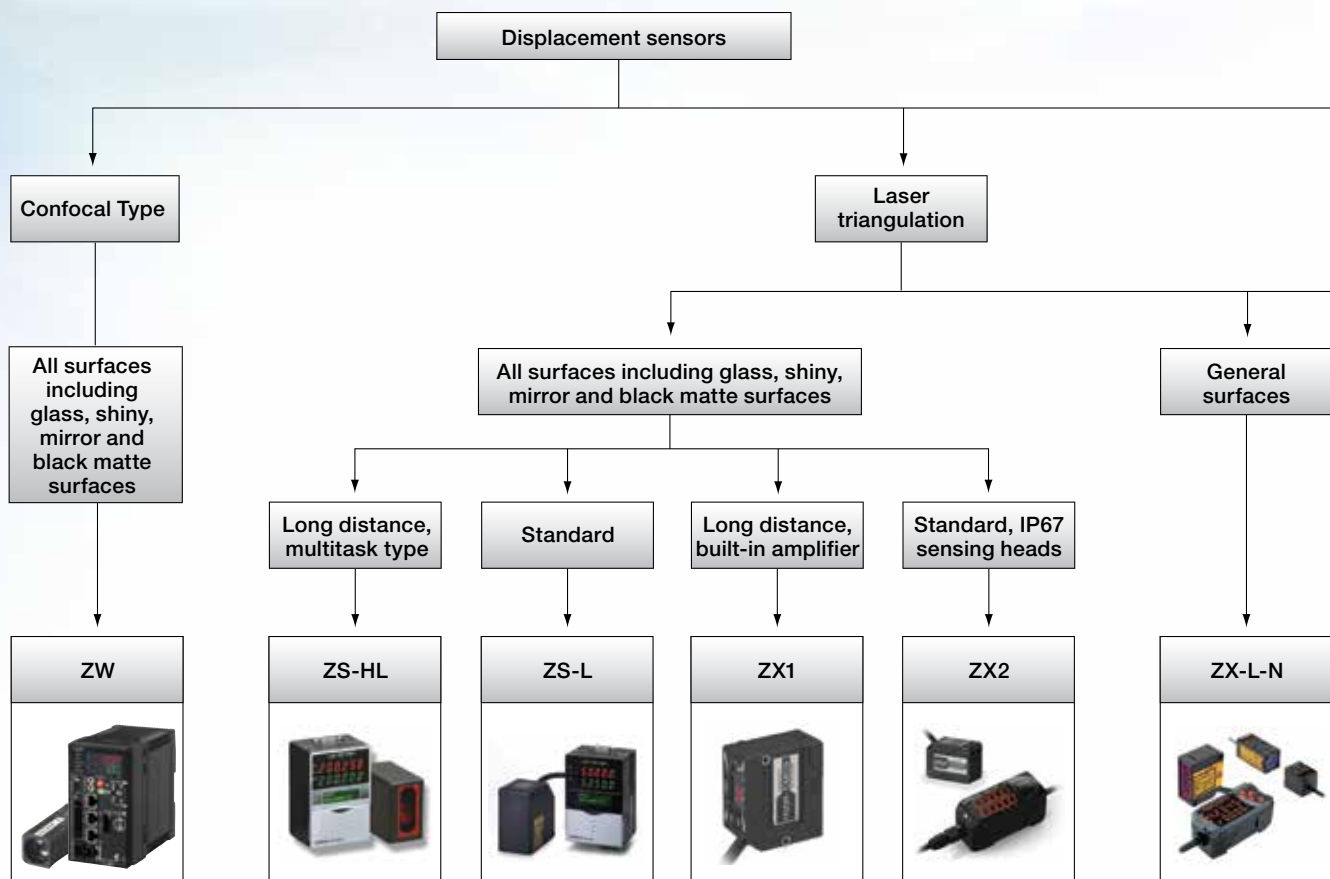

The Smart displacement sensor family offers a modular and scalable approach to solve the most challenging measurement tasks. This powerful portfolio enables you to measure profiles, thickness, distance, evenness/warpage, as well as width, edge, and more. Several measurement profiles can be performed simultaneously, using a single- or multi-controller unit. Aided by Omron's advanced technologies, the highest accuracy over long distances, speed and reliability will be achieved.

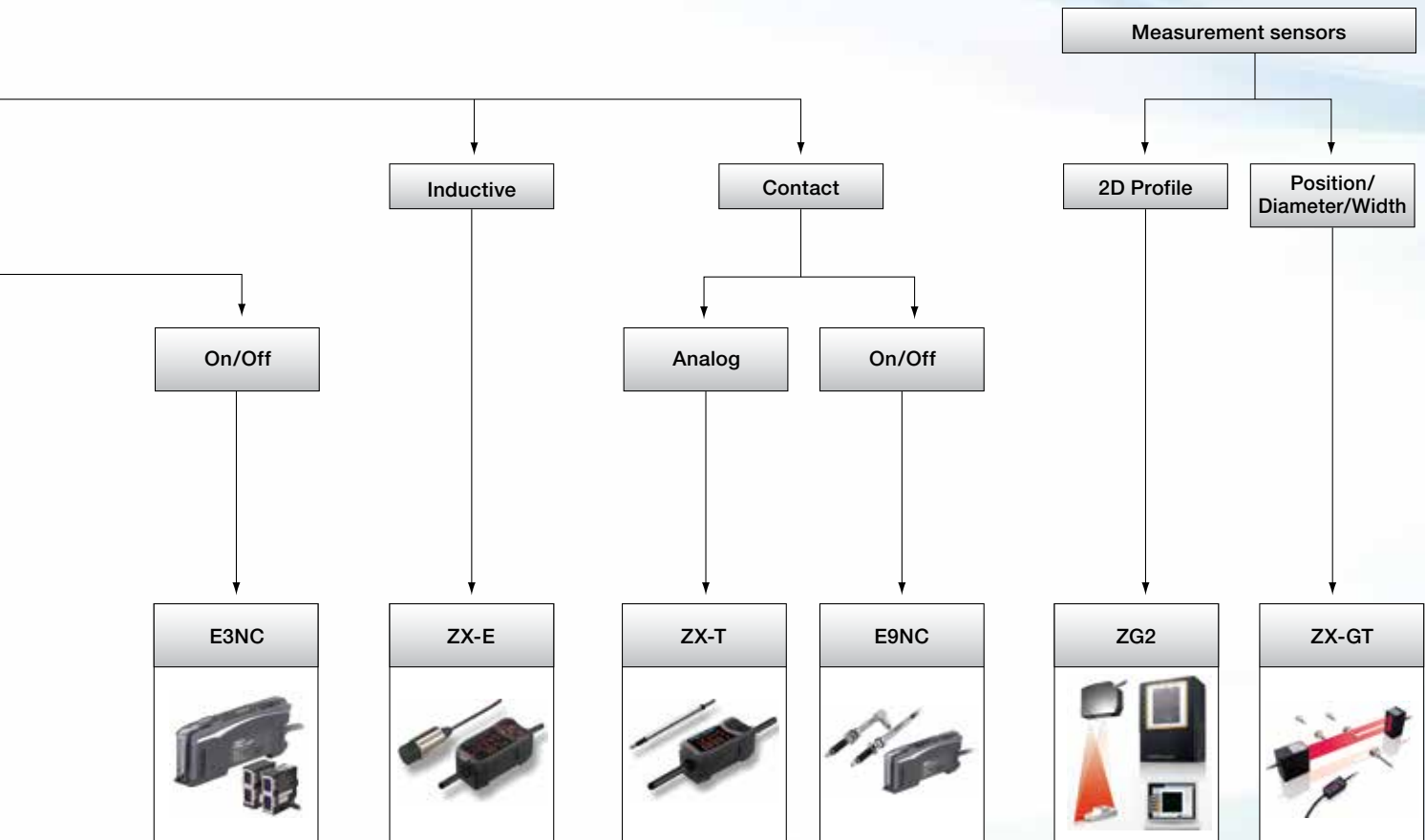
- Accurate and fast – models available with 0.25  $\mu\text{m}$  at less than 110  $\mu\text{s}$  sampling time
- Scalable – multi-controller connectivity allows coordinate measurement with multiple points
- Smart – data storage and remote control via networking capabilities





# Selection Table

		1D Smart laser measuring sensors			
					
Model		ZS-HL	ZS-L	ZX-L-N	ZW
Selection criteria	Measurement range Z Min.	10 ±0.5 mm	20 ±1 mm	30 ±2 mm	2 ±1 mm
	Max.	1500 ±500 mm	350±135 mm	300 ±200 mm	40 +/- 6 mm
	Spot diameter Min.	–	–	–	40 µm
	Max	–	–	–	80 µm
	Resolution	0.25 µm	0.25 µm	0.25 µm	0.25 µm
	Resolution X	–	–	–	–
	Linearity (±% of full scale)	0.05%	±0.1%	0.2%	Note <sup>1</sup>
	Response time	110 µs	110 µs	150 µs	500 µs
	Spot beam	■	■	■	■
	Line beam	■	■	■	–
	IP-rating head	IP64/IP67	IP66 (0.5 m); IP67 (2 m)	IP50	IP40
	IP-rating controller	IP40	IP40	IP40	IP20
	Ambient operating temperature	0 to 50°C	0 to 50 C°	0 to 50°C	0 to 50°C
	Number of connectable sensors	9	9	5	1
Features	Thickness measurement	■	■	■	■
	Eccentricity	■	■	■	–
	Height	■	■	■	■
	Step	■	■	■	–
	Profile	–	–	–	–
	Distance	■	■	–	■
	Evenness	–	–	–	–
	Warpage	–	–	–	–
	Edge	–	–	–	–
	Width	–	–	–	–
	Peak	■	■	■	■
	Peak to peak	■	■	■	■
	Bottom	■	■	■	■
	Self-trigger	■	■	■	■
	Calibration	■	–	■	■
	Signal scaling	–	–	■	■
	PC-software	■	■	■	■
Application	Mirror	■	■	–	■
	Glass	■	■	–	■
	Metal	■	■	□	■
	Plastic	■	■	■	■
	Black rubber	■	■	–	■
	Paper	■	■	□	■
Supply voltage	VDC	21.6 to 26.4 VDC	21.6 to 26.4 VDC	12 to 24 VDC	21.6 to 26.4 VDC
	4 to 20 mA	■	■	■	■
Control I/O	1 to 5 VDC	–	■	■	-10 to +10 V
	Judgement output High/Pass/Low	■	■	■	■
	Trigger	■	■	■	■
Communication	RS-232C	■	■	■	■
	USB 2.0	■	■	–	–
	Ethernet	–	–	–	■

■ Standard    □ Available    – No/not available

Note<sup>1</sup>: See lens specifications



# Measurement Sensors

		1D Smart laser measuring sensors	1D Smart laser measuring sensors	Inductive measuring sensors	Contact measuring sensors
					
Selection criteria	Model	ZX1	ZX2	ZX-E	ZX-T
	Measurement range Z Min.	50 ±10 mm	48 ±5 mm	0.5 mm	1 mm
	Max.	600+/-400 mm	100±35 mm	7 mm	10 mm
	Spot diameter Min.	0.17 mm	60 µm	-	-
	Max	0.56 mm	110 µm	-	-
	Resolution	2 to 80 µm	1.5 µm - 5 µm	1 µm	0.1 µm
	Resolution X	-	-	-	-
	Linearity (±% of full scale)	0.15 to 0.5% F.S.	±0.05 to 0.1% F.S.	0.5%	0.3%
	Response time	1 ms	30 µs	150 µs	1 ms
	Spot beam	■	■	-	-
	Line beam	■	■	-	-
	IP-rating head	IP67	IP67	IP67	IP67
	IP-rating controller	-	IP40	IP40	IP40
	Ambient operating temperature	-10 to +55°C	0 to +50°C	0 to 50°C	0 to 50°C
Number of connectable sensors	1	5	5	7	
Features	Thickness measurement	-	■	■	■
	Eccentricity	-	■	■	■
	Height	■	■	■	■
	Step	-	■	■	■
	Profile	-	-	-	-
	Distance	■	■	■	■
	Evenness	-	■	■	■
	Warpage	-	■	■	■
	Edge	-	-	-	-
	Width	-	■	-	-
	Peak	■	■	■	■
	Peak to peak	■	■	■	■
	Bottom	■	■	■	■
	Self-trigger	-	■	■	■
	Calibration	■	■	■	-
	Signal scaling	-	■	■	■
	PC-software	-	-	■	■
	Application	Mirror	■	■	-
Glass		■	■	-	■
Metal		■	■	■	■
Plastic		■	■	-	■
Black rubber		■	■	-	■
Paper		■	■	-	-
Supply voltage	VDC	10 to 30 VDC	10 to 30 VDC	12 to 24 VDC	12 to 24 VDC
Control I/O	4 to 20 mA	■	■	■	■
	1 to 5 VDC	-	■ and ±5 V	■	■
	Judgement output High/Pass/Low	■	■	■	■
	Trigger	■	■	■	■
Communication	RS-232C	-	-	■	■
	USB 2.0	-	-	-	-

■ Standard    □ Available    - No/not available

\* For unit specifics see data sheets.

# Measurement Sensors

		Profile measuring sensor	Smart laser micrometer
			
Selection criteria	Model	<b>ZG2</b>	<b>ZX-GT</b>
	Measurement range Z Min.	22.3 ±0.5 mm	–
	Max.	210 ±48 mm	28 mm
	Spot diameter Min.	3 mm	–
	Max	70 mm	–
	Resolution	0.25 µm	10 µm
	Resolution X	* 631 pixels	–
	Linearity (±% of full scale)	0.5%	0.1%
	Response time	5 ms	0.5 ms
	Spot beam	–	–
	Line beam	■	■
	IP-rating head	IP66/67	IP40
	IP-rating controller	IP20	IP40
	Ambient operating temperature	0 to 50°C	0 to 50°C
	Number of connectable sensors	1	5
Features	Thickness measurement	■	■
	Eccentricity	■	■
	Height	■	■
	Step	■	–
	Profile	□	–
	Distance	■	–
	Evenness	–	–
	Warpage	–	–
	Edge	–	■
	Width	■	■
	Peak	■	■
	Peak to peak	■	■
	Bottom	■	■
	Self-trigger	■	■
	Calibration	■	–
Signal scaling	–	■	
PC-software	■	■	
Application	Mirror	■	■
	Glass	■	■
	Metal	■	■
	Plastic	■	■
	Black rubber	■	■
	Paper	■	■
Supply voltage	VDC	21.6 to 26.4 VDC	24 VDC
Control I/O	4 to 20 mA	■	■
	1 to 5 VDC	-10 to +10 V	■
	Judgement output High/Pass/Low	■	■
	Trigger	■	■
Communication	RS-232C	■	■
	USB 2.0	■	–

■ Standard    □ Available    – No/not available

\* For unit specifics see data sheets.





## CMOS Laser Displacement Sensor with Built-in Amplifier

Smart sensor for simple measurements that do not require additional equipment for configuration. All-in-one laser now provides ease of use and stable measurements for any type of work piece. Different sensing distance ranges provide a solution for every application.

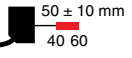
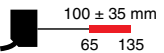

- Amplifier setup built into laser sensor
- Long distance model up to 1,000 mm
- Pre-wired connector version allows extension up to 20 m
- IP67 heads and Robotic cables

## Ordering Information

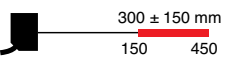
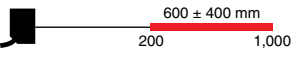
Shape	Spot diameter	Connection method	Cable length	Sensing distance	NPN output model	PNP output model	
	0.17 mm	Pre-wired	2 m		ZX1-LD50A61 2M	ZX1-LD50A81 2M	
			5 m		ZX1-LD50A61 5M	ZX1-LD50A81 5M	
		Pre-wired connector	0.5 m		ZX1-LD50A66 0.5M	ZX1-LD50A86 0.5M	
	0.33 mm	Pre-wired	2 m			ZX1-LD100A61 2M	ZX1-LD100A81 2M
			5 m			ZX1-LD100A61 5M	ZX1-LD100A81 5M
		Pre-wired connector	0.5 m			ZX1-LD100A66 0.5M	ZX1-LD100A86 0.5M
	0.52 mm	Pre-wired	2 m			ZX1-LD300A61 2M	ZX1-LD300A81 2M
			5 m			ZX1-LD300A61 5M	ZX1-LD300A81 5M
		Pre-wired connector	0.5 m			ZX1-LD300A66 0.5M	ZX1-LD300A86 0.5M
	0.56 mm	Pre-wired	2 m			ZX1-LD600A61 2M	ZX1-LD600A81 2M
			5 m			ZX1-LD600A61 5M	ZX1-LD600A81 5M
		Pre-wired connector	0.5 m			ZX1-LD600A66 0.5M	ZX1-LD600A86 0.5M

## Extension Cables

Order extension cables for Pre-wired Connector Models only.

Cable length	Model
10 m	ZX0-XC10R
20 m	ZX0-XC20R

## CMOS Laser Displacement Sensor

This next generation smart sensor provides stable measurements with ease of use. Achieve accurate measurements for distance and thickness calculations even with product in motion. The CMOS sensor provides repeatable measurements for any color or surface condition.

- 11 Segment display for easy configuration
- World's smallest CMOS head with laser life display
- 4 bank function for easy setup changeover
- IP67 heads and robotic cables



## Ordering Information

### Sensor Heads

Appearance	Optical system	Beam shape	Sensing distance	Resolution	Model
	Diffuse reflective	Line beam	50±10mm 40 60	1.5 μm	ZX2-LD50L
		Spot beam			ZX2-LD50
		Line beam	100±35mm 65 135	5 μm	ZX2-LD100L
		Spot beam			ZX2-LD100
	Regular reflective	Spot beam	48±5mm 43 53	1.5 μm	ZX2-LD50V

### Amplifiers

Description	Power supply	Analog output (Switch selectable)	Discrimination output function	Output type	Model
Amplifier with 2 m cable	12 to 24 VDC	4 to 20 mA, 1 to 5 VDC, ±5 VDC	High, Pass, Low	NPN	ZX2-LDA11 2M
				PNP	ZX2-LDA41 2M

### Communications Interface Unit

Appearance	Type	Model
	RS-232C	ZX2-SF11

### Calculating Unit

Appearance	Model
	ZX2-CAL

### Mounting Brackets

Contents	Applicable sensor heads	Model
Mounting bracket: 1	ZX2-LD50V, ZX2-LD50L, ZX-LD50	E39-L178
Nut plate: 1 Phillips screws (M3x30): 2	ZX-LD100L, ZX-LD100	E39-L179

### Sensor Head Extension Cables

Length	Model
1 m	ZX2-XC1R
4 m	ZX2-XC4R
9 m	ZX2-XC9R
20 m	ZX2-XC20R

## Smart, Fast Laser Measurement Sensor

Smart ZX-L offers simple setup and measurement for applications where high resolution and fast response time are required. A wide range of interchangeable sensor heads provides great flexibility in solving demanding applications.

- Small and light sensor heads for easy integration
- High-speed response time of 150  $\mu$ s
- Easy sensor head replacement
- Scalability through a modular platform concept



## Ordering Information

### Reflective Sensing Heads

Sensing method	Sensing distance	Beam shape	Resolution	Dimensions (H x W x D mm)	Model
Diffuse reflective	40 $\pm$ 10 mm	Spot, 50 mm dia.	2 $\mu$ m	39 x 33 x 17	ZX-LD40
	100 $\pm$ 40 mm	Spot, 100 mm dia.	16 $\mu$ m		ZX-LD100
	300 $\pm$ 200 mm	Spot, 300 mm dia.	300 $\mu$ m		ZX-LD300
	40 $\pm$ 10 mm	Line, 75 $\mu$ m x 2 mm	2 $\mu$ m		ZX-LD40L
	100 $\pm$ 40 mm	Line, 150 $\mu$ m x 2 mm	16 $\mu$ m		ZX-LD100L
	300 $\pm$ 200 mm	Line, 450 $\mu$ m x 2 mm	300 $\mu$ m		ZX-LD300L
Regular reflective	30 $\pm$ 2 mm	Spot, 75 mm dia.	0.25 $\mu$ m	45 x 55 x 25	ZX-LD30V
		Line, 100 $\mu$ m x 1.8 mm			ZX-LD30VL

### Through-beam Sensing Heads

Sensing method	Sensing distance	Measuring width	Resolution	Dimensions (H x W x D mm)	Model
Through-beam	0 to 2000 mm	1 mm dia.	4 $\mu$ m	15 x 15 x 34 emitter; 15 x 15 x 19 receiver	ZX-LT001
		5 mm dia.		20 x 20 x 42 emitter; 20 x 20 x 25 receiver	ZX-LT005
	0 to 500 mm	10 mm dia.	20 x 64 x 68 emitter; 20 x 64 x 58 receiver	ZX-LT010	
		30 mm dia.	20 x 64 x 58 receiver	ZX-LT030	

## Amplifiers

Description	Power supply	Analog output (Switch selectable)	Discrimination output function	Output type	Model
Amplifier with 2 m cable	12 to 24 VDC	4 to 20 mA, 1 to 5 VDC, 0 to 5 VDC, $\pm$ 4 VDC, $\pm$ 5 VDC	High, Pass, Low	NPN	ZX-LDA11N 2M
				PNP	ZX-LDA41N 2M

## Accessories

Please refer to data sheet for Attachments, Extension cables, Software, Calculating unit and Communications module.

## Scalable Precision Laser Measurement Sensor

Smart ZS-L sensor offers high-precision, high-speed and high-sensitivity inspections and detects nearly all surfaces.

- Sensitive enough to measure thickness of coating or sealer on glass
- High resolution of 0.25  $\mu\text{m}$
- Fast response time of 110  $\mu\text{s}$  for accurate measurements of moving work pieces
- Sensor head with 2D-CMOS technology delivers high dynamic sensing range to measure black rubber, plastic, shiny glass and mirror surfaces



## Ordering Information

### Sensing Heads

Sensing method	Measurement center distance	Measurement range	Beam type	Beam diameter	Resolution*	Model
Diffuse reflective	50 mm	$\pm 5$ mm	50 - Line	900 x 60 $\mu\text{m}$	0.8 $\mu\text{m}$	ZS-LD50
		$\pm 15$ mm	50S - Spot	50 $\mu\text{m}$		ZS-LD50S
	80 mm	50 mm +/- 5 mm	80 - Line	900 x 60 $\mu\text{m}$	2 $\mu\text{m}$	ZS-LD80
	130 mm	$\pm 15$ mm	130 - Line	900 x 70 $\mu\text{m}$	3 $\mu\text{m}$	ZS-LD130
	200 mm	$\pm 50$ mm	200 - Line	900 x 100 $\mu\text{m}$	5 $\mu\text{m}$	ZS-LD200
	350 mm	$\pm 135$ mm	350S - Spot	240 $\mu\text{m}$ dia.	20 $\mu\text{m}$	ZS-LD350S
Regular reflective	20 mm	$\pm 1$ mm	20T - Line	900 x 25 $\mu\text{m}$	0.25 $\mu\text{m}$	ZS-LD20T
		20 mm +/- 1 mm	20ST - Spot	25 $\mu\text{m}$		ZS-LD20ST
	40 mm	$\pm 2.5$ mm	40T - Line	2000 x 35 $\mu\text{m}$	0.4 $\mu\text{m}$	ZS-LD40T

\*Resolution is the peak-to-peak displacement conversion value in the displacement output at the measuring center distance in high-precision mode, when the number of samples to average is set to 128, and the measuring mode is set to high-resolution mode. The standard work piece is white aluminum ceramic for diffuse reflection heads and glass in the regular reflection heads.

## Controllers

Description	Supply voltage	Control outputs	Model
Sensor Controllers	24 VDC	NPN outputs	ZS-LDC11
		PNP outputs	ZS-LDC41
Multi-Controllers for Calculation	24 VDC	NPN outputs	ZS-MDC11
		PNP outputs	ZS-MDC41
Data Storage Units Support Data Logging	24 VDC	NPN outputs	ZS-DSU11
		PNP outputs	ZS-DSU41

## Accessories

Extension cables, Software, Communications cables, Mounting adapters, and Controller Link connector.

## High-Precision Long Distance Laser Measurement Sensors

High performance sensors support critical quality inspection with precise measurements over long distances.

- Sensor heads support measuring center distances from 20 to 1,500 mm
- Achieves a maximum high resolution of 0.25  $\mu\text{m}$
- Solve tough inspection problems: Stable measurement of black rubber, black resin, glass and metal sheets, and printed circuit boards
- Fast response time of 110  $\mu\text{s}$  for accurate measurements of moving work pieces



## Ordering Information

### Sensing Heads

Sensing method	Measuring range [Sensing distance]	Beam size/ measuring region	Resolution	FDA laser class	Model
Regular	20 mm $\pm$ 1 mm	1.0 mm x 20 $\mu\text{m}$	0.25 $\mu\text{m}$	Class II	ZS-HLDS2T 2M
Diffuse	5.2 mm $\pm$ 1 mm				
Regular	50 mm $\pm$ 5 mm	1.0 mm x 30 $\mu\text{m}$	0.1 $\mu\text{m}$		ZS-HLDS5T 2M
Diffuse	44 mm $\pm$ 4 mm				
Regular	100 mm $\pm$ 20 mm	3.5 mm x 60 $\mu\text{m}$	1.0 $\mu\text{m}$		ZS-HLDS10 2M
Diffuse	94 mm $\pm$ 16 mm				
Regular	600 mm $\pm$ 350 mm	16 mm x 0.3 mm	8 $\mu\text{m}$ @ 250 mm, 40 $\mu\text{m}$ @ 600 mm	ZS-HLDS60	
	1500 mm $\pm$ 500 mm	40 mm x 1.5 mm	500 $\mu\text{m}$	ZS-HLDS150	

### Series Sensor Heads for Nozzle Gaps

Optical system	Sensing distance	Beam shape	Beam diameter	Resolution	Model
Regular reflective models	10 $\pm$ 0.5 mm	Line beam	900 x 25 $\mu\text{m}$	0.25 $\mu\text{m}$	ZS-LD10GT
	15 $\pm$ 0.75 mm				ZS-LD15GT

### Series Sensor Controllers

Shape	Supply voltage	Control outputs	Model
	24 VDC	NPN outputs	ZS-HLDC11
		PNP outputs	ZS-HLDC41

### Accessories

Extension cables, Software, Communications cables, Mounting adapters, Controller Link and Controller options.

## Smart Inductive Displacement Sensor

Smart ZX-E offers simple setup for applications requiring non-contact displacement measurements of metal objects. A wide range of interchangeable sensor heads provides great flexibility in solving demanding applications.

- Compact inductive sensor heads for easy integration
- High-speed response time of 150  $\mu$ s
- Easy sensor head replacement
- Scalability through a modular platform concept



## Ordering Information

### Inductive Sensing Heads

Shape	Dimensions	Sensing distance	Resolution	Model
Unthreaded cylindrical	3 dia. x 18 mm	0.5 mm	1 $\mu$ m	ZX-EDR5T
	5.4 dia. x 18 mm	1 mm		ZX-ED01T
	8 dia. x 22 mm	2 mm		ZX-ED02T
Threaded cylindrical	M10 x 22 mm	2 mm		ZX-EM02T
	M18 x 46.3 mm	7 mm		ZX-EM07MT
Flat	30 x 14 x 4.8 mm	4 mm		ZX-EV04T
Heat-resistant, cylindrical	M12 x 22 mm	2 mm		ZX-EM02HT

### Amplifiers

Description	Power supply	Analog output (Switch selectable)	Discrimination output function	Output type	Model
Amplifier with 2 m cable	12 to 24 VDC	4 to 20 mA, 1 to 5 VDC, 0 to 5 VDC, $\pm$ 4 VDC, $\pm$ 5 VDC	High, Pass, Low	NPN	ZX-EDA11 2M
				PNP	ZX-EDA41 2M

### Accessories

Please refer to data sheet for Mounting brackets, Extension cables, Software, Calculating unit and Communications module.

## Smart Contact Displacement Sensor

Smart ZX-T offers simple setup for applications requiring high-precision contact displacement measurements to verify part shape and orientation.

- Slim sensor heads make it easy to integrate
- Fast response time of 1 ms
- Multipoint measurement with up to 7 sensors
- Dust-tight linear ball bearing construction assures long service life: 10 million mechanical operations minimum



## Ordering Information

### Contact Sensing Heads

Type	Sensing distance	Resolution	Tip size	Dimensions (sensing head)	Model
Short type	1 mm	0.1 $\mu$ m	4.5 dia. mm	57.1 L x 6 dia. mm	ZX-TDS01T
Standard type	4 mm			86 L x 6 dia. mm	ZX-TDS04T
Low-load type				ZX-TDS04T-L	
Standard type	10 mm	0.4 $\mu$ m	5 dia. mm	123 L x 8 dia. mm	ZX-TDS10T
Ultra-low-load type			7.5 dia. mm	132.15 L x 8 dia. mm	ZX-TDS10T-L
Vacuum retracting type			5 dia. mm	129.5 L x 8 dia. mm	ZX-TDS10T-V
Vacuum retracting/Air push type			7 dia. mm	124.5 L x 8 dia. mm	ZX-TDS10T-VL

## Amplifiers

Description	Power supply	Analog output (Switch selectable)	Discrimination output function	Output type	Model
Amplifier with 2 m cable	12 to 24 VDC	4 to 20 mA, 1 to 5 VDC, 0 to 5 VDC, $\pm$ 4 VDC, $\pm$ 5 VDC	High, Pass, Low	NPN	ZX-TDA11 2M
				PNP	ZX-TDA41 2M

## Accessories

Please refer to data sheet for Actuator options, Mounting brackets, Extension cables, Software, Calculating unit and Communications module.

## Ultra-compact, Lightweight Sensor Measures Any Material

The ZW confocal fiber displacement sensor delivers stable, non-contact, in-line measurement of heights, thicknesses and other dimensions. It solves the problems of traditional laser triangulation sensors: deviation between different material with inclination tolerance. The compact sensing head has no electronic parts to eliminate problems of installation space and mutual interference, electrical/magnetic noise, temperature rise and mechanical positioning.

- Ultra-compact sensing head: 24 x 24 mm; weighs only 105 g
- High flexibility fiber-optic cable from sensor to controller, extends up to 32 m
- Mount sensing head one time: no need to re-tune for changing materials



- Separate amplifier provides white LED light source, spectroscope and processor to convert reflected color light to distance
- Smart Monitor ZW Software simplifies setup and data collection/analysis
- EtherCAT models includes EtherNet/IP communications interface

## Ordering Information

### Sensor Heads

Measuring range	Spot diameter	Static resolution	Model*
7 ±0.3 mm	18 µm dia.	0.25 µm	ZW-S07□M
20 ±1 mm	40 µm dia.	0.25 µm	ZW-S20□M
30 ±3 mm	60 µm dia.	0.25 µm	ZW-S30□M
40 ±6 mm	80 µm dia.	0.25 µm	ZW-S40□M

\*Note: Cable length, 03 = 0.3m and 2 = 2m (specified in meters) should be added in place of the box at the end of the part number.

### Right Angle Sensor Heads

Measuring range	Spot diameter	Static resolution	Model*
7 ±0.3 mm	18 µm dia.	0.25 µm	ZW-SR07□M
20 ±1 mm	40 µm dia.	0.25 µm	ZW-SR20□M
40 ±6 mm	80 µm dia.	0.25 µm	ZW-SR40□M

### Cables

Description	Feature	Cable length	Model
Sensor head to controller extension cable	Fiber-optic cable; includes Fiber Adapter ZW-XFC	2 m	ZW-XF02R
		5 m	ZW-XF05R
		10 m	ZW-XF10R
		20 m	ZW-XF20R
		30 m	ZW-XF30R
Fiber adapter	Coupler between fibers	-	ZW-XFC
Parallel I/O Cable	Input/Output Wiring	2 m	ZW-XCP2E
Controller to personal computer cable	RS-232C cable	2 m	ZX-XRS2
Controller to PLC/HMI cable	RS-232C cable	2 m	ZW-XPT2

## Controllers and Software

Dimensions	Power supply	Output type	Software included	Model
124 x 72 x 128 mm	24 VDC	NPN	No	ZW-CE10T
124 x 72 x 128 mm	24 VDC	PNP	No	ZW-CE15T
Fiber Optic Cleaner				ZW-XCL
SYSMAC Software & License				Contact Omron or see website for details



## Wide Laser Beam CCD Measurement Sensor

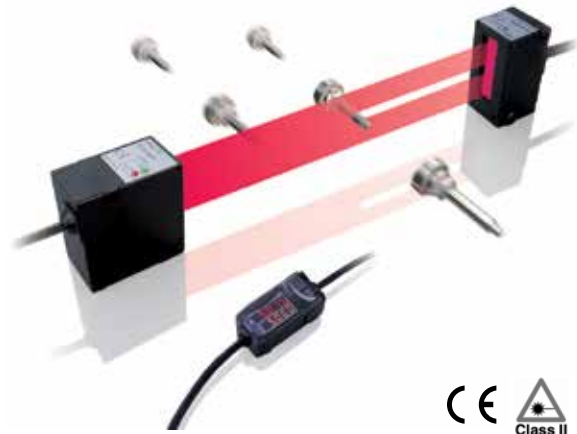

Now you can accurately and reliably get precision measurements of 10  $\mu\text{m}$  at a distance of up to 500 mm by using the ZX-GT. The ZX-GT provides unparalleled measurement precision with high-speed measurement of 2,000 samples per second. The ZX-GT's ability to measure glass and mirror surfaces along with its "Smart Recipe" PC software, makes the ZX-GT the most powerful and easy to use measurement sensor in its class.



- 10  $\mu\text{m}$  accuracy by 500 mm range
- High-speed processing of 2,000 images per second ensures fast, accurate in-line measurements
- Dedicated glass detection function
- "Smart Recipe" software makes setup easy

## Ordering Information

### Sensor

Appearance	Optical system	Measuring width	Sensing distance	Resolution	Output type	Model
Separate type 	Through-beam	28 mm	0 to 500 mm	10 $\mu\text{m}$	NPN	ZX-GT28S11
					PNP	ZX-GT28S41
Integrated type 			40 mm		NPN	ZX-GT2840S11
					PNP	ZX-GT2840S41

### Amplifiers

Appearance	Power supply	Output type	Model
	DC	NPN	ZX-GTC11
		PNP	ZX-GTC41

### Accessories

Please refer to data sheet for Extension cables, Software, Calculating unit and Communications module.

Q

## 2D Measurement Sensor

The ZG2 sensor measures the height and width of entire objects simultaneously, using a wide laser beam.

- All-in-one controller with built-in LCD display
- Measure entire shapes in 2D, X and Z axis
- Immediate live feedback
- Fast 5 ms sampling time
- Accuracy as fine as 0.25  $\mu\text{m}$



## Ordering Information

### Sensing Heads

Measurement mode	Measurement range regular reflective	Measurement range diffuse reflective	Beam size/ measuring region	Resolution X dir/Z dir	FDA laser class	Model
Regular reflective	22.3 $\pm$ 0.5 mm	10.6 $\pm$ 0.4 mm	3 mm	5 $\mu\text{m}$ / 0.25 $\mu\text{m}$	Class II	ZG2-WDS3VT 0.5M
						ZG2-WDS3VT 2M
Diffuse reflective	44 $\pm$ 2 mm	50 $\pm$ 3 mm	8 mm	13 $\mu\text{m}$ / 1 $\mu\text{m}$	Class IIIb	ZG2-WDS8T 0.5M
						ZG2-WDS8T 2M
	94 $\pm$ 10 mm	100 $\pm$ 12 mm	22 mm	35 $\mu\text{m}$ / 2.5 $\mu\text{m}$		ZG2-WDS22 0.5M
						ZG2-WDS22 2M
	mode not available	210 $\pm$ 48 mm	70 mm	111 $\mu\text{m}$ / 6 $\mu\text{m}$		ZG2-WDS70 0.5M
ZG2-WDS70 2M						

## Controller

Description	Power supply	Analog output (Switch selectable)	Discrimination output function	Output type	Model
Controller	24 VDC	4 to 20 mA, -10 to 10 VDC	All Pass/NG/Error	NPN	ZG2-WDC11
				PNP	ZG2-WDC41
				NPN	ZG2-WDC11A
				PNP	ZG2-WDC41A

Note: Models with 'A' suffix includes Smart Monitor ZG Set-up Software.

## Accessories

Extension cables, Software, Communications cables, Mounting adapters, and Controller Link connector.

## Contents

Selection Guide	R-ii
<b>Absolute Rotary Encoders</b>	
E6C3-A Standard, 50 mm dia.	R-2
E6CP-A Plastic body, 50 mm dia.	R-3
E6F-A Rugged housing, 60 mm dia.	R-4
<b>Incremental Rotary Encoders</b>	
E6A2-C Small diameter encoder, 25 mm dia.	R-5
E6B2-C Small diameter encoder, 40 mm dia.	R-6
E6C3-C Standard, 50 mm dia.	R-7
E6D-C Rugged housing, Narrow shaft, 40 mm dia.	R-8
E6F-C Rugged housing, Narrow shaft, 60 mm dia.	R-8

## ACCURACY AND ROBUSTNESS MADE RELIABLE

Close the loop – angle, position and velocity on hand

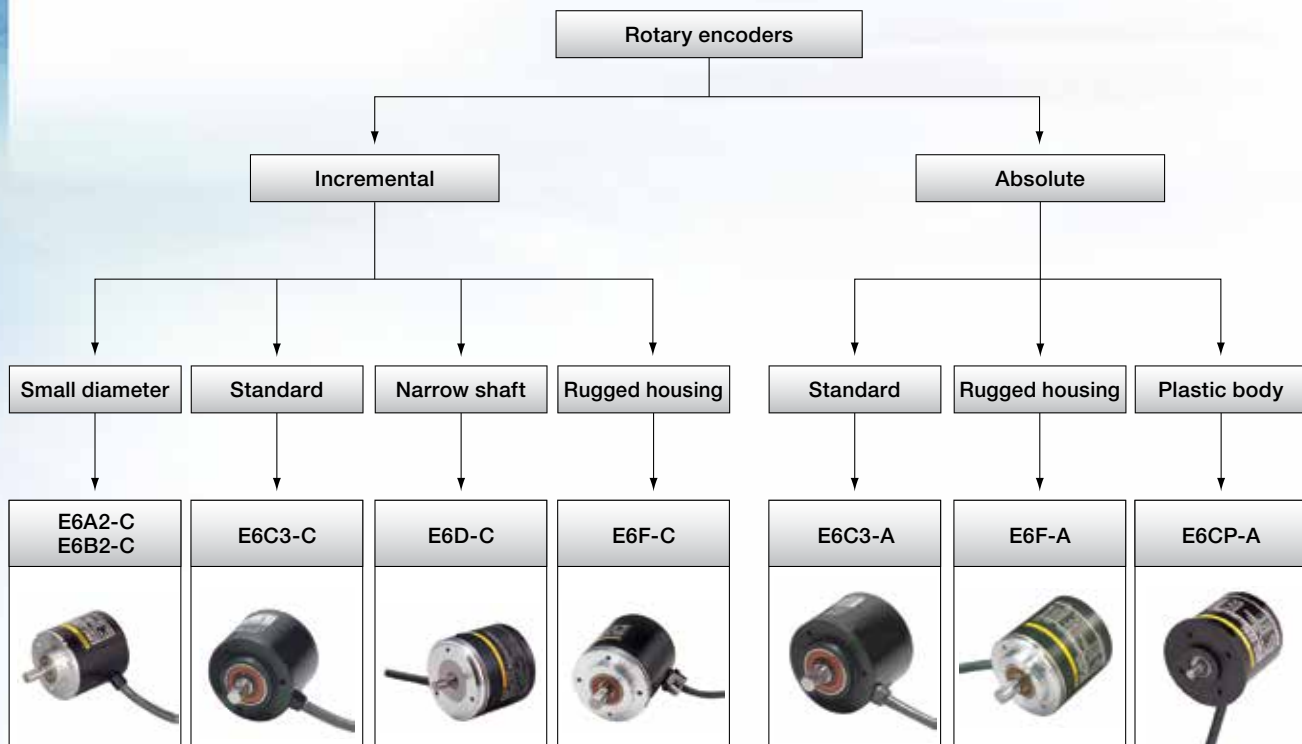

Rotary encoders create information which represent the movement of your application. To meet challenging demands, Omron offers a wide range of absolute and incremental encoders.

- Wide resolution variety
- Models with rugged housing
- Models for multi-turn applications



# Selection Table

Output		Incremental				
						
Model		E6A2-C	E6B2-C	E6D-C	E6C3-C	E6F-C
Type		Small diameter shaft	Small diameter shaft	Small diameter shaft	Standard	Rugged housing
Resolution range (Pulse/rev)	Min	10	10	10	100	100
	Max	500	2,000	6,000	3,600	1,000
Output	NPN	■	■	■	■	■
	PNP	—	■	—	—	—
Size dia. (mm)		25	40	55	50	60
Max. force	Radial	10 N	30 N	50 N	80 N	120 N
	Axial	5 N	20 N	30 N	50 N	50 N
IP rating	IP50	■	■	■	—	—
	IP64	—	—	—	—	—
	IP65	—	—	—	■	■
Max. rotation frequency (rpm)		5,000	6,000	12,000	5,000	5,000

Output		Absolute		
				
Model		E6C3-A	E6F-A	E6CP-A
Type		Standard	Rugged housing	Lightweight, plastic body
Resolution range (Pulse/rev)	Min	6	256	10
	Max	1,024	1,024	256
Output	NPN	■	■	■
	PNP	■	■	—
Size dia. (mm)		50	60	50
Max. force	Radial	80 N	120 N	30 N
	Axial	50 N	50 N	20 N
IP rating	IP50	—	—	■
	IP64	—	—	—
	IP65	■	■	—
Max. rotation frequency (rpm)		5,000	5,000	1,000

■ Standard    □ Available    — No/not available

## Water Resistant Encoder for Tough Environments

- IP65 drip-proof, oil-proof construction with sealed bearing
- 8 mm stainless steel shaft provides superior shaft loading performance: Radial: 8 kg-f; Axial: 5.1 kg-f
- NPN, or PNP open collector or voltage outputs
- Optimum angle control when combined with cam positioner (stand-alone H8PS or PLC-based) or encoder-input PLC position control modules
- Response frequency: 20 kHz max., 5,000 rpm max
- Pre-wired with 1 meter cable; 2 meter cable available, connector version available for direct connection to an H8PS Cam Positioning Unit



## Ordering Information

When ordering, specify the resolution in addition to the model number (example: E6C3-AG5C 360P/R 1M).

Size	Shaft	Supply Voltage	Output configuration	Output code	Resolution (pulses/rotation)	Connection method	Model
50 dia. x 43 D mm	8 dia. x 15 L mm, stainless steel	12 to 24 VDC	NPN open-collector output	Gray	256, 360, 720	2 m connector for H8PS Cam Positioner	E6C3-AG5C-C
					256, 360, 720, 1,024		Pre-wired, 1 m cable
				Binary	32, 40	E6C3-AN5C	
			BCD	6, 8, 12	E6C3-AB5C		
			PNP open-collector output	Gray	256, 360, 720, 1,024	E6C3-AG5B	
				Binary	32, 40	E6C3-AN5B	
		BCD		6, 8, 12	E6C3-AB5B		
		Voltage output		Binary	256	E6C3-AN1E	
					E6C3-AN2E		
				5 VDC			
		12 VDC					

## Low-Cost Absolute Encoder, 50 mm Diameter

- High-precision detection of automatic machine timing, also ideal for robot limit signals
- Absolute encoder performance at the cost of an incremental encoder
- Gray code output eliminates reading mistakes
- Lightweight, plastic body construction, IP50 enclosure rating
- Shaft loading: Radial: 3 kg-f; Axial: 2 kg-f
- Open collector output
- Response frequency: 5 kHz max., 1,000 rpm max
- Pre-wired with 2 m cable, connector version available for direct connection to an H8PS Cam Positioning unit



## Ordering Information

Size	Shaft	Power supply voltage	Output configuration	Output code	Resolution (pulses/rotation)	Connection method	Model
50 dia. x 55 D mm	6 dia. x 10 L mm	5 to 12 VDC	Open-collector output	Gray	256 (8-bit)	Pre-wired, 2 m cable	E6CP-AG3C
		12 to 24 VDC					E6CP-AG5C
						2 m cable with connector for H8PS Cam Positioner	E6CP-AG5C-C

## Rugged Encoder for High-Precision Detection

- 10 mm stainless steel shaft and rugged construction provide the highest shaft loading among Omron encoders: Radial: 12 kg-f, Thrust: 5 kg-f
- IP65f water and oil-proof construction
- High response speed for faster control: Gray code: 20 kHz; BCD: 10 kHz, 5,000 rpm max
- Combine with H8PS Cam Positioner or PLC encoder input module for optimum angle control
- Pre-wired with 2 m cable, connector version available for direct connection to an H8PS Cam Positioning unit



## Ordering Information

When ordering, specify the resolution in addition to the model number (example: E6C3-AG5C 360P/R 1M).

Size	Shaft	Power supply voltage	Output configuration	Output code	Resolution (pulses/rotation)	Connection method	Model
60 mm dia. x 65 D mm	10 dia. x 20 L mm	5 to 12 VDC	NPN open collector	BCD	360	Pre-wired 2 m cable	E6F-AB3C
		12 to 24 VDC	PNP open collector				E6F-AB5C
			NPN open collector				E6F-AB5B
		12 to 24 VDC	NPN open collector	Gray code	256, 360, 720	2 m cable with connector for H8PS Cam Positioner	E6F-AG5C-C
			NPN open collector	Gray code	256, 360, 720, 1,024	Pre-wired 2 m cable	E6F-AG5C
			PNP open collector				E6F-AG5B



## Rugged Encoder for High-Precision Detection

- High response frequency and noise immunity make encoders ideal for factory automation applications with 10 to 500 pulses/revolution
- Space saving enclosure: 25 mm dia.
- 4 mm shaft with load rating of: Radial: 1 kg-f; Axial: 0.5 kg-f
- Open collector output, other output types available
- Output phases: A/A, B and A, B, Z (reversible) are available
- Response frequency: 20 kHz max., 5,000 rpm max
- Enclosure rating: IP50
- Pre-wired with 0.5 meter cable



## Ordering Information

Size	Shaft	Supply voltage	Output configuration	Resolution (pulses/revolution)	Model
25 dia. x 31 D mm	4 dia. x 10 L mm	12 to 24 VDC	NPN open collector, 30 mA max	100	E6A2-CW5C 100P/R 05M
				200	E6A2-CW5C 200P/R 05M

R

## General-Purpose Compact Encoders

- High resolution models (up to 2000 pulses per revolution available) substantially improve measuring accuracy
- Rugged construction: 6 mm shaft with load rating of: Radial: 3 kg-f; Axial: 2 kg-f
- Output phases: A, B, Z (reversible)
- Response frequency: up to 100 kHz max., 6,000 rpm max
- Protected against short-circuit and reversed connections for highly reliable operation
- Available with NPN and PNP open collector, voltage and line driver outputs
- Enclosure rating: IP50
- Pre-wired with 0.5- or 2 m cables



## Ordering Information

Size	Shaft	Supply voltage	Output configuration	Resolution (pulse/revolution)	Cable length	Model
40 mm dia. x 44 D mm	6 dia. x 15 L mm	12 to 24 VDC	NPN open collector, 35 mA max	100	2 m	E6B2-CWZ6C 100P/R 2M
				200		E6B2-CWZ6C 200P/R 2M
				360	0.5 m	E6B2-CWZ6C 360P/R 05M
				360	2 m	E6B2-CWZ6C 360P/R 2M
				500		E6B2-CWZ6C 500P/R 2M
				600		E6B2-CWZ6C 600P/R 2M
				1000	0.5 m	E6B2-CWZ6C 1000P/R 05M
					2 m	E6B2-CWZ6C 1000P/R 2M
		5 VDC	Line driver: High: -20 mA or 2.5 V min Low: +20 mA or 0.5 V max	0.5 m	E6B2-CWZ1X 1000P/R 05M	

## Water Resistant Incremental Encoder for Tough Environments

- High resolution solutions from 100 to 3600 pulses/revolution
- IP65f drip-proof, oil-proof construction with sealed bearing
- 8 mm stainless steel shaft provides a load rating of: Radial: 88 kg-f; Axial: 5 kg-f
- Complementary outputs simplify interfacing to NPN or PNP input devices
- Output phases: A, B and Z (reversible)
- Response frequency: 125 kHz max. (65 kHz for Z-phase), 5,000 rpm max
- Surge protection built-in
- Voltage and line driver output versions available
- Pre-wired with 1 meter cable, 2 meter cable is available

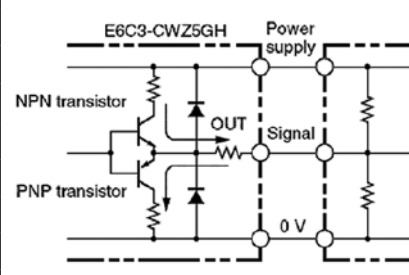

## Ordering Information

Size	Shaft	Supply Voltage	Output configuration	Resolution (pulse/revolution)	Model
50 dia. x 43 D mm	8 dia. x 15 L mm, stainless steel	12 to 24 VDC	Complementary output (NPN and PNP), 35 mA max. 	100	E6C3-CWZ5GH 100P/R 1M
				200	E6C3-CWZ5GH 200P/R 1M
				360	E6C3-CWZ5GH 360P/R 1M
				500	E6C3-CWZ5GH 500P/R 1M
				720	E6C3-CWZ5GH 720P/R 1M
				800	E6C3-CWZ5GH 800P/R 1M
				1000	E6C3-CWZ5GH 1000P/R 1M
				2048	E6C3-CWZ5GH 2048P/R 1M
				2500	E6C3-CWZ5GH 2500P/R 1M
				3600	E6C3-CWZ5GH 3600P/R 1M

R

# E6D-C Rotary Encoders – Incremental

Quick Link  
F528  
omron247.com

## Rugged, High-Resolution Encoder

- Resolution as high as 6,000 pulses/revolution in a rugged construction
- Outputs: A, B (reversible) and Z (zero)
- 55 mm diameter housing
- Superb reliability and accuracy: phase error as small as  $1/4T \pm 0.07T$
- High response frequency of 200 kHz, 12,000 rpm max
- 6 mm shaft with load rating of: Radial: 5 kg-f; Axial: 3 kg-f



## Ordering Information

Size	Shaft	Supply voltage	Output configuration	Resolution (pulses/revolution)	Cable length	Model
44 mm dia. x 44 D mm	6 dia. x 15 L mm	12 VDC	NPN open collector, 35 mA max	720, 800, 1000, 1024, 1200, 1500, 1800, 2000, 2048, 2500, 3000, 3200, 3600, 4096, 5000, 6000	0.5 m	E6D-CWZ2C□□□□P/R 05M
		5 VDC				E6D-CWZ1E□□□□P/R 05M

# E6F-C Rotary Encoders – Incremental

Quick Link  
F529  
omron247.com

## Rugged, High-Resolution Encoder

- 10 mm stainless steel shaft and rugged construction provides the highest shaft loading among Omron encoders; Radial: 12 kg-f, Thrust: 5 kg-f
- IP65f water and oil-proof construction
- 60 mm diameter housing
- Complementary output for longer cable length extension
- High response frequency of 83 kHz, 5,000 rpm max
- Output load short-circuit protection to reduce risks from incorrect wiring
- Pre-wired 2 m cable



## Ordering Information

Size	Shaft	Supply voltage	Output configuration	Resolution (pulses/revolution)	Cable length	Model
60 mm dia. x 65 D mm	10 dia. x 20 L mm	12 to 24 VDC	Complementary NPN and PNP, $\pm 30$ mA	100, 200, 360, 500, 600, 1000	2 m	E6F-CWZ5GP/R 2M

## Contents

Selection Guide		S-ii
<b>Linear Code Readers</b>		
MS-3	Ultra-Compact Laser Reader	S-1
QX830	Compact Industrial Laser Scanner	S-2
QX870	Industrial Raster Laser Scanner	S-3
Hawk Series	Industrial 1D/2D code reading imagers	S-4
HS/ MobileHawk	Hand-held 1D/2D code readers	S-5
TCS1400 Series	Hand-held CCD Bar Code Readers	S-6
TCS1490	Long Range Bar Code Reader	S-6
<b>2-Dimensional Code Readers</b>		
V400-H	Hand-held reader for direct-stamped 2D codes	S-7
FQ-CR	Multi-code reader and DPM code reader	S-8
V400-R2	Ultra-small multi code reader, both 2D & 1D code compatible paper/label	S-9
V500-R2	Compact high-speed linear code reader fits almost anywhere	S-9

<b>Industrial RFID Systems</b>		
V680S	HF - 13.56 MHz All-in-one System - Antenna/ Amplifier/Controller (page S-11)	S-10
V680 Series	HF - 13.56 MHz Next-Generation RFID Systems with ISO/ IEC 18000-3 (ISO/ IEC 15693) Compliance	S-11
V680- HAM42- DRT	HF - 13.56 MHz V680-Series DeviceNet-Compatible Slaves for RFID Systems. Read and Write up to 58 Bytes	S-12
V680- HAM91/ HAM81	HF - 13.56 MHz RFID System can be used just like a sensor	S-12
V640	LF- 134 kHz Systems reads TIRIS tags more reliably than OEM parts	S-13
V750	UHF - 902.75 - 927.75 MHz EPC Class I Gen 2 Interrogator	S-14

## AUTO IDENTIFICATION SYSTEMS

Omron offers a wide range of reliable identification systems to help you track, trace and verify product moving through your factory, and between warehouse and retail locations. We offer 1D barcode readers, 2D code readers and radio frequency identification (RFID) systems to meet your specific needs. With over 25 years of experience applying radio frequency identification systems, Omron offers unique skills in integrating them for a complete industrial automation solution.

**RFID systems:** UHF for long distance and asset tracking (V750); HF for industrial work-in-progress and tool or part identification (V680); LF for tracking in semiconductor manufacturing settings (V640).



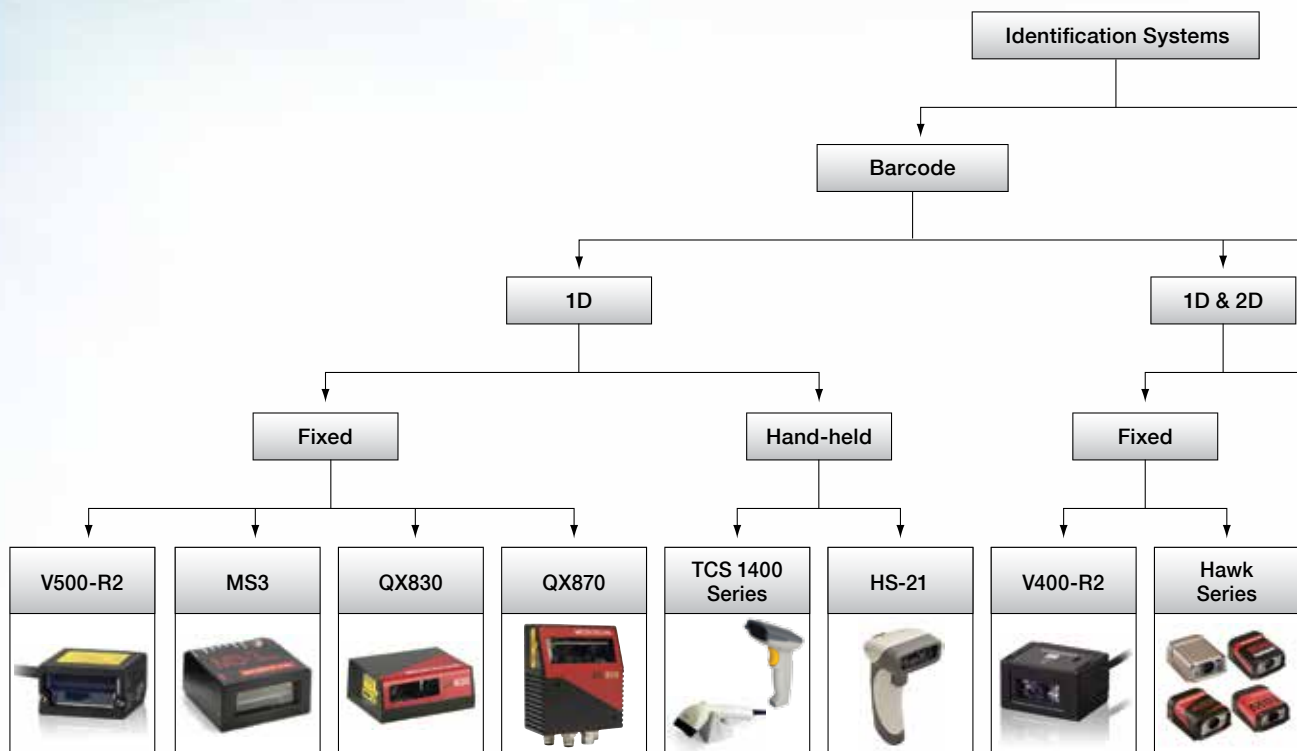

**2D code readers:** CMOS and video imaging models accurately read printed, embossed and engraved codes with great stability. Choose fixed mounting and held-held models.

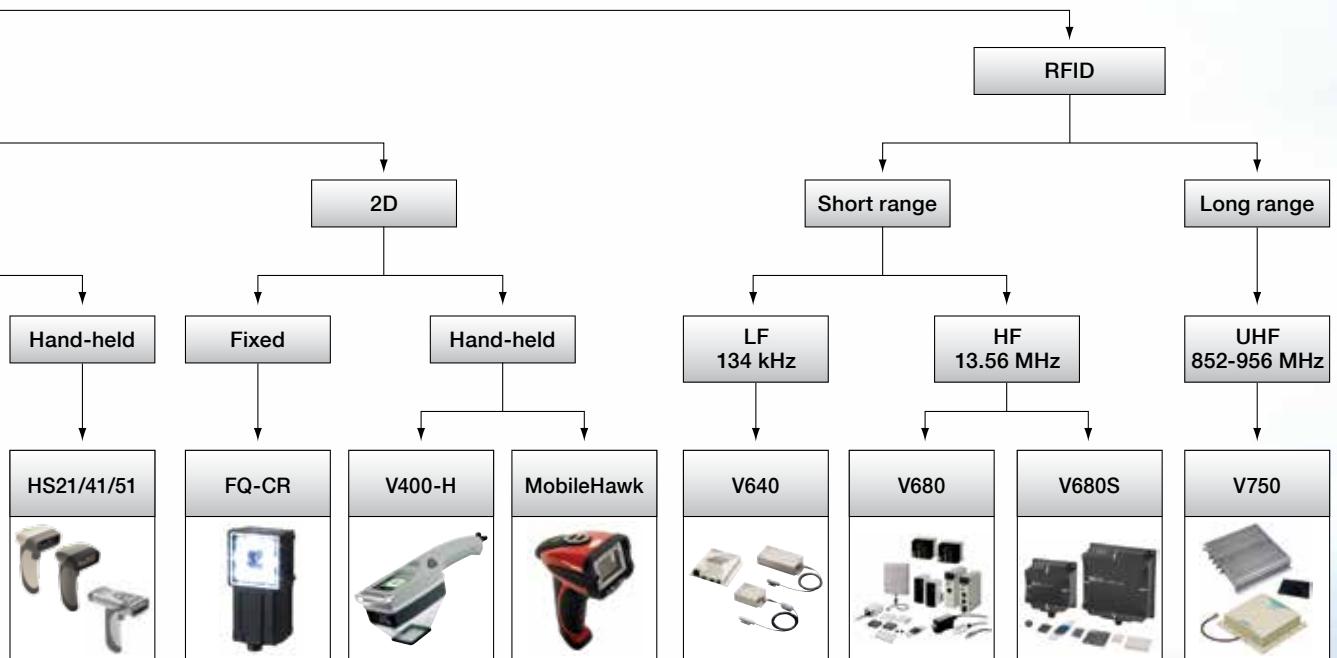
**1D barcode readers:** Laser and CCD imaging versions read most popular code types at high speed. Choose fixed mounting and hand-held models.











# Selection Table

Category		Identification Systems				
						
Model		FQ-CR	V400-R2	V400-H	MS-3	QX830
Type		Imager	Imager	Imager	Laser	Laser
Read ranges		●	●	●	●	●
Resolution		512 x 484, 752 x 480	754 x 480	–	Model Specific	Model Specific
IP rating		IP67	IP54	IP64	IP54	IP65
Supply voltage		24 VDC	5 VDC	5 VDC	5 VDC	10-28 VDC
Codes	1D	JAN/EAN/UPC, Code39, Codabar (NW-7), ITF (Interleaved 2 of 5), Code 93, Code128/GS1-128, GS1 DataBar* (Truncated, Stacked, Omni-directional, Stacked Omni-directional, Limited, Expanded and Expanded Stacked), Pharmaco- code and GS1-128 Composite Code (CC-A, CC-B, CC-C))	WPC(JAN/EAN/UPC), Codabar(NW-7), ITF, Industrial 2 of 5, Code39,Code93, Code128, GS1-128(EAN-128), GS1-Databar(RSS-14),GS1-Databar Limited(RSS Limited), GS1-Databar Expanded (RSS Expanded), GS1-Databar Composite(RSS Composite)	–	All Standard	All Standard
	Stacked	–	PDF417 RSS	–	–	MicroPDF PDF417 GS1 Databar
	2D	• Data Matrix (ECC200) • QR Code • Micro QR Code • PDF417 • MicroPDF417 • GS1-DataMatrix	• Data Matrix (ECC200) • QR Code • Micro QR Code • MicroPDF417 • AztecCode • MaxiCode • Codablock-F	• Data Matrix: ECC200, 10 x 10 to 64 x 64, 8 x 18 to 16 x 48 • QR Code (Models 1, 2): 21 x 21 to 57 x 57 (Versions 1 to 10)	–	–
	PC software	Optional	Optional	Optional	ESP	ESP
Communications interfaces	RS-232	–	■	■	■	■
	RS-422/RS-485	–	–	–	■	■
	Ethernet	■	–	–	–	■
	DeviceNet	–	–	–	□	□
	USB	–	–	–	–	–
	Bluetooth	–	–	–	–	–

● See data sheet for individual model specifications    ■ Standard    □ Available    – No/not available







# Auto Identification Systems

Category		Identification Systems					
							
Model		V500-R2	QX870	Hawk Series	HS/ MobileHawk	TCS 1400	TCS1490
Type		Laser	Laser	Imager	Imager	Imager	Imager
Read ranges		●	●	●	●	●	●
Resolution		Bar code 0.15 mm	Model Specific	Model Specific	Model Specific: 2048 pixel imager 1280 x 1024 CMOS	2160 CCD - one line	3648 CCD - one line
IP rating		IP54	IP65	IP54	●	IP54	IP54
Supply voltage		5 VDC	10-28 VDC	5 VDC	5 VDC	5 VDC	5 VDC
Codes	1D	WPC(JAN/EAN/UPC), Codabar (NW-7), ITF, Industrial 2 of 5 (STF), Code39, Code93, Code128, GS1-128 (EAN-128), GS1-Databar (RSS-14), GS1-Databar Limited(RSS Limited), GS1-Databar Expanded (RSS Expanded)	All Standard	All Standard Model Specific: Postal Codes	All Standard Model Specific: Postal Codes	UPC/EAN w/ 2 - 5 add. Code39, I 2 of 5, Code 93, Code 128, Codeabar MSI/PLESSY	UPC/EAN w/ 2 - 5 add. Code39, I 2 of 5, Code 93, Code 128, Codeabar, MSI/PLESSY
	Stacked	–	MicroPDF PDF417 GS1 Databar	MicroPDF PDF417 GS1 Databar	PDF417 GS1 Databar Model Specific: MicroPDF	–	–
	2D	–	–	Model Specific: • Data Matrix • QR Code • Micro QR Code • Aztec	Model Specific: • Data Matrix • QR Code • Micro QR Code • Aztec • Maxicode	–	–
PC software		–	ESP	ESP	ESP	–	–
Communications interfaces	RS-232	■	■	■	□	■	■
	RS-422/RS-485	–	■	RS-422	–	–	–
	Ethernet	–	■	–	–	–	–
	DeviceNet	–	□	□	–	–	–
	USB	–	–	□	■	■	□
	Bluetooth	–	–	–	–	–	□

● See data sheet for individual model specifications    ■ Standard    □ Available    – No/not available



## Selection Table

Radio Frequency Identification Systems (RFID)				
				
Model	V640	V680	V680S	V750
Detection range	Short distance	Short distance	Short distance	Long distance
Operating frequency	LF 134 kHz	HF 13.56 MHz	HF 13.56 MHz	UHF 852-956 MHz
Regional broadcast approvals	US and Europe: FCC Part 15 Subpart C; FCC ID: E4E6CYCIDV6400304; EC/R&TTE Directive  Conforms to carrier reader/writer-related SEMI standards; SEMI E99, E4, and E5	US, Canada, Mexico, Latin America, Europe, Singapore, Malaysia, the Philippines, Japan, China, Hong Kong, Taiwan, Korea  Conforms to ISO/ IEC 18000-3 (ISO/IEC 15693); FCC Standards and R&TTE Directive	US, Canada, Mexico, Latin America, Europe, Singapore, Malaysia, the Philippines, Japan, China, Hong Kong, Taiwan, Korea  Conforms to ISO/ IEC 18000-3 (ISO/IEC 15693); FCC Standards and R&TTE Directive	US, Canada, Europe, Japan, China
Interface ports	V3 - RS-232C interface, ETN - Ethernet interface (compatible with SECS I/II protocol)	RS-232C, RS-422, RS- 485, DeviceNet	M12 8 pin	Ethernet, RS-232C
Host devices	PC	PC, Omron CJ/CS series PLC, 3rd-party PLC, DeviceNet	PC, Omron series PLC, 3rd-party PLC	PC
Controllers	Standalone	Standalone, PLC-mount	Standalone	Standalone
Antennas supported	1	1 or 2	1 or 2	Up to 4 Mono Static antennas (transmit/ receive integrated)
Read/write antennas	Rectangular (50 x 30 x 12 mm including mounting plate )	Cylindrical, compact with separate amplifier, rectangular with built- in amplifier models available - see literature for details	-	Rectangular (221 x 221 x 70 mm)
Data carriers (tags)	RI-TRP series tags	1 kbyte EEPROM; 2 , 8 or 32 kbyte FRAM	1, 2 or 8 kbytes	EPCglobal Class 1 Generation 2 (ISO18000-6 Type C)

## Ultra-Compact Laser Reader

At 1,000 decodes per second, the MS-3 Laser offers the fastest read performance in the class of embedded compact bar code scanners. The wide scan angle of 70 degrees coupled with ultra-compact size and flexible mounting make the MS-3 Laser the optimal choice for high-speed reading in OEM instruments. High performance and flexibility are designed into virtually every aspect of the MS-3 Laser. Optics are factory-adjustable and our feature-rich firmware can be customized to satisfy almost any application. The MS-3 is well-suited for any embedded bar code application where size, performance, and budget savings are core factors.



- Decodes/second: Up to 1000
- Read range: 2 to 10" (51 to 254 mm)
- Wide scan angle
- IP54 enclosure

### Application Examples

- Clinical instruments
- Bank ATMs
- Parking kiosks
- Point-of-sale terminals
- Robotics

### Symbologies Supported

- Code 93
- Code 39
- Code 128
- Codabar
- Pharmacode
- Interleaved 2 of 5
- UPC/EAN
- PDF417 (option)

## Ordering Information

### Scanners

Description	Part Number
MS3 Laser Raster Low Density - Omron PLC connect w/M12 power	FIS-0003-0217G
MS3 Laser Raster High Density - Omron PLC connect w/M12 power	FIS-0003-0218G
MS3 Laser Single Line Low Density - Omron PLC connect w/M12 power	FIS-0003-0219G
MS3 Laser Single Line Low Density - Omron PLC connect w/M12 power	FIS-0003-0215G

For accessories, see product literature for details

## Compact Industrial Laser Scanner

The QX830 combines flexible connectivity with high-performance decoding capabilities to reliably read 1D barcodes in almost any automation environment. In addition to the Quick Connect System and X-Mode Technology, the QX830 features an EZ button for quick reader setup and configuration, with no computer required.



- Decodes/second: 300 to 1400
- Read Range: 1 to 30" (25 to 762 mm)
- Optional Embedded Ethernet TCP/IP & EtherNet/IP
- X-Mode Technology: Decodes damaged, poorly printed, or misaligned codes
- IP65 Enclosure



### Symbologies

#### Linear



#### Stacked



MicroPDF PDF417GS1

Databar

## Ordering Information

### Scanners

Description	Part Number
Single Line Scanner, Low Density - Serial	FIS-0830-0001G
Single Line Scanner, Medium Density - Serial	FIS-0830-0002G
Single Line Scanner, High Density - Serial	FIS-0830-0003G
Raster Line Scanner, Low Density - Serial	FIS-0830-0004G
Raster Line Scanner, Medium Density - Serial	FIS-0830-0005G
Raster Line Scanner, High Density - Serial	FIS-0830-0006G
Single Line Scanner, Low Density - Serial + Ethernet	FIS-0830-1001G
Single Line Scanner, Medium Density - Serial + Ethernet	FIS-0830-1002G
Single Line Scanner, High Density - Serial + Ethernet	FIS-0830-1003G
Raster Line Scanner, Low Density - Serial + Ethernet	FIS-0830-1004G
Raster Line Scanner, Medium Density - Serial + Ethernet	FIS-0830-1005G
Raster Line Scanner, High Density - Serial + Ethernet	FIS-0830-1006G

For cable part numbers and configuration with accessories, see product literature.

## Industrial Raster Laser Scanner

The QX870 makes reading bar codes and stacked 2D codes easy. Push-button calibration and a fully programmable feature set enable you to quickly and easily configure the scanner to meet your needs. Raster settings are programmable to read multiple symbols at different locations or at varying distances.

- Decodes/second: 300 to 1400
- Read Range: 1 to 30" (25 to 762 mm)
- Optional Embedded Ethernet TCP/IP & EtherNet/IP
- X-Mode Technology: Decodes damaged, poorly printed, or misaligned codes
- IP65 Enclosure



## Symbologies

### Linear



### Stacked



MicroPDF PDF417

GS1 Databar

## Ordering Information

### Scanners

Description	Part Number
Sweeping Raster Barcode Scanner, Low Density - Serial	FIS-0870-0001G
Sweeping Raster Barcode Scanner, Medium Density - Serial	FIS-0870-0002G
Sweeping Raster Barcode Scanner, High Density - Serial	FIS-0870-0003G
Sweeping Raster Barcode Scanner, Low Density - Serial + Ethernet	FIS-0870-1001G
Sweeping Raster Barcode Scanner, Medium Density - Serial + Ethernet	FIS-0870-1002G
Sweeping Raster Barcode Scanner, High Density - Serial + Ethernet	FIS-0870-1003G

### Cables

Description	Part Number
QX Power Supply Cable, M12 12-pin Socket 1.3m	97-000003-01
QX Cordset, Host Serial M12 12-pin Socket 1m	61-000152-01
QX Cordset, Host Ethernet, M12 8-pin plug to RJ45 1m	61-000160-01

For cables and accessories, see product literature for details



# Hawk Series

## Industrial 1D/2D Code Reading Imagers

Quick Link

D725

omron247.com

### Industrial Ultra-compact, Auto-focus Mega Pixel Imager

It is the ideal imager for automation engineers who need flexibility to read any code, at any distance, at any speed. Quadrus MINI reads both linear bar codes and 2D codes in any orientation, while in motion. EZ button setup, symbol locator, and visible performance indicators provide ease of use while large area reading and small form factor allow for positioning flexibility.

**Auto-focus:** Position your symbol at the center of the field of view and push the EZ button for a true auto focus experience. Quadrus MINI automatically adjusts for distance to focus on the symbol and sets internal parameters to optimize reading of symbol.

**Mega Pixel Processing:** Mega Pixel processing allows for reading multiple small, high-density codes or long 1D codes. Quadrus MINI can read down to 3.3 mil high-density codes and can decode up to 100 symbols within the field of view in a single read capture. Three optical versions are available.

**Dynamic, Omni-Directional Reading:** The Quadrus MINI decodes linear bar codes or 2D codes omni-directionally in moving applications, at speeds up to 100 feet per minute (0.5 meters/second).

**Push-Button Set-up:** The EZ button is a powerful set-up feature. Three

### Ordering Information

#### MS-4

Description	Part Number
MS-4 2D Imagers	FIS-0004-000_G
MS-4X 2D Imagers	FIS-0004-200_G
MS-4 Xi, Standard Density, Ethernet	FIS-1004-1210G
MS-4 Xi, Low Density, Ethernet	FIS-1004-1110G

See Data sheet for specific model part numbers and cables configuration.

#### MS Hawk

Description	Part Number
Mini Hawk, 3Mp Imagers	FIS-6300-201_G
Mini Hawk High Resolution Imagers	FIS-6300-400_G
Mini Hawk High Speed Imagers	FIS-6300-500_G
Mini Hawk Xi HR and HS imagers	FIS-6310-1__0G

Accessories: See Data Sheet for Cables and configuration.



programmable positions can be used to perform tasks including: Read Rate, Auto-focus/Calibration, Save for Power-on, Load New Master, and Sleep Mode.

- Decodes/second: up to 10
- Read range: 1 to 10" (25 to 254 mm)
- 1.3 megapixel processing
- Patented Quadrus technology
- Auto-focus
- Wide-scan angle
- IP65 Enclosure

### Symbologies

#### Linear Bar Codes:

- Code 39
- Code 128
- BC 412
- I2 of 5
- Pharmacode
- UPC/EAN
- Codabar
- Code 93

#### 2D Symbologies:

- Data Matrix (ECC 0-200)
- QR Code

#### Stacked Symbologies:

- PDF417
- Micro PDF417
- RSS (Composite & Stacked)

### Hand-held Automatic 1D and 2D Imagers

Hand-held imagers have fast and accurate performance and are built to withstand industrial environments.

- HS-2D and MobileHawk read linear and 2D codes; HS1 reads linear and stacked codes
- HS1 and HS21/41 are available in USB or RS-232 interface options
- ESP® Easy Set-up Program provides single-point configuration
- Easy-to-use Point and Click targeting, HS-2D and MobileHawk have audible/vibrating indicators
- MobileHawk with X-Mode Technology decodes damaged, poorly printed, or misaligned codes



### Symbologies - Model specific

#### Linear



All Standard



Postal Codes

#### Stacked



MicroPDF



PDF417



GS1 Databar

#### 2D



Data Matrix



QR



Micro QR



Aztec

### Ordering Information

#### Readers

Description	Part Number
2D Handheld Reader, USB	FIS-HS21-0001G
2D Handheld Reader, RS232C	FIS-HS21-0002G
2D DPM Handheld Reader, USB	FIS-HS41X-0001G
2D DPM Handheld Reader, RS232C	FIS-HS41X-0002G

#### Accessories

Description	Part Number
HS Handheld Power Supply 5VDC	20-000335-02
HS Handheld Presentation Stand	98-000270-03
Mobile Hawk DPM Reader, USB	FIS-6170-0001G
Mobile Hawk - RS232 cable and Power Supply	96-000074-04



# TCS1400 Series Linear Code Reader

**Quick Link**  
**D726**  
omron247.com

## Hand-held CCD Bar Code Readers

- High-move tolerance provides accurate reading of bar codes on moving work pieces.
- Ergonomic design and rugged construction for reliable operation without maintenance or adjustments.
- Reads all standard bar codes: UPC/EAN, Codabar, Code 39, Code 93, Code 128, and Interleaved 2 of 5. It can also read UPC/EAN with 2 or 5 digit addendum



## Ordering Information

### Scanners

Description	Part Number
Handheld barcode scanner 2.8" Near Contact- Omron PLC interface	TCS-1440-OP
Handheld barcode scanner 2.8" Near Contact - PC interface	TCS-1440-OR
Handheld barcode scanner 3.2" Near Contact- Omron PLC interface	TCS-1470-OP
Handheld barcode scanner 3.2" Near Contact - PC interface	TCS-1470-OR

### Accessory

Description	Part Number
TCS-1440 and 1470 Barcode Readers Stand	BCS-9029

For cables and accessories, see product literature for details

# TCS1490 Series Linear Code Reader

**Quick Link**  
**D727**  
omron247.com

## Long-Range Bar Code Reader

- Read range: 1" to 30" (25 to 762 mm)
- Video/CCD Imager has no moving parts to wear out or need adjustment
- Modular design allows for quick and easy cable changes this allows one bar code reader to be used in multiple environments
- Rugged construction built to withstand industrial and commercial environments.



## Ordering Information

### Scanners

Description	Part Number
Handheld barcode scanner Omron PLC RS-232C direct connect interface	TCS-1492OP
Handheld barcode scanner PC interface	TCS-1492OR

### Accessory

Description	Part Number
TCS1492 Barcode Reader Stand	BCS-1490

For cables and accessories, see product literature for details



## Hand-Held 2-Dimensional Code Reader with Built-In Monitor

- Read directly marked 2-dimensional codes on metal parts, printed circuit boards, and electronic components
- Display reading results in four patterns to match your application
- Easy-to-press trigger buttons and light weight 230 g (approx. 8 oz) reduce operator fatigue
- Change settings without connecting to a PC
- Equipped with both coaxial illumination and oblique illumination, reader automatically switches to match the object being read, accounting for different reflection factors
- Built-in LCD monitor confirms the position of the 2D code then displays the reading results and image



- Simplify positioning with optional detachable aiming guide 
- Read data can be time-stamped then stored on a commercially available SD memory card
- Connect to a 5 VDC power supply or use optional AC adapter

## Ordering Information

### Hand-Held Reader

Item	Description	Model
Hand-held 2D code reader	3 x 3 mm field of vision; RS-232C serial interface	V400-SH111-1 (See note 1)
	5 x 5 to 10 x 10 mm field of vision; RS-232C serial interface	V400-H111
	15 x 15 to 30 x 30 mm field of vision; RS-232C serial interface	V400-H211
Contact for positioning	Detachable aiming guide simplifies accurate positioning for high-efficiency operation	V400-AC2
Power supply	Provides 5 VDC from AC line power	S8VS-01505
AC adapter	Provides 5 VDC directly from supply 115 VAC outlet	V600-AC22

Note: 1. V400-SH111-1 sold as an assembled kit, consisting of; Micro code reader V400-H111-1, contactor, and communication cable.

Power converter is required, but not included.

## Cables

Item	Description	Length	Model
Communications cable	For Omron PLC connection, with power cord	2 m	V400-W20-2M
		5 m	V400-W20-5M
	For PC-compatible connection, with power cord	2 m	V400-W21-2M
		5 m	V400-W21-5M
	For PC-compatible connection when using AC adapter	2 m	V400-W22-2M
		5 m	V400-W22-5M

### Highly Advanced, Multi-functional Code Reader That Can Handle Low-contrast and Glossy Surfaces

- Multi code reader (FQ-CR1 Series)
- 2D code reader for direct part marking codes (FQ-CR2 Series)
- High-power LEDs
- HDR function to cut out ambient light interference
- Polarizing filter to cut specular reflections



### Ordering Information

#### Code Reader

Wide View(Long-distance)

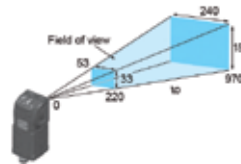

Narrow View

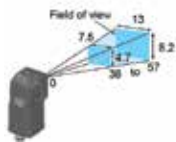

Standard

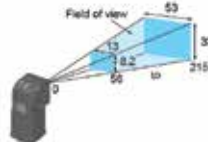

Wide View(Long-distance)

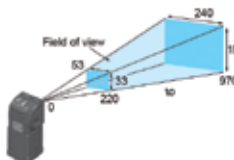

(Short-distance)

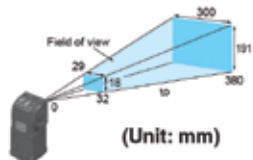

(Unit: mm)

	Narrow View		Standard		Wide View (Long Distance)		Wide View (Short Distance)	
	2D Code	Multi Code	2D Code	Multi Code	2D Code	Multi Code	2D Code	Multi Code
NPN	FQ-CR20010F-M	FQ-CR10010F-M	FQ-CR20050F-M	FQ-CR10050F-M	FQ-CR20100F-M	FQ-CR10100F-M	FQ-CR20100N-M	FQ-CR10100N-M
PNP	FQ-CR25010F-M	FQ-CR15010F-M	FQ-CR25050F-M	FQ-CR15050F-M	FQ-CR25100F-M	FQ-CR15100F-M	FQ-CR25100N-M	FQ-CR15100N-M

### Touch Finder

Type	Model
DC power supply	FQ2-D30
AC/DC/battery	FQ2-D31

### Cables

Cable Length	Type	Model	Type	Model
2 m	FQ Ethernet cables (connect sensor to touch Finder, Sensors to PC)	FQ-WN002	I/O cables	FQ-WD002
5 m		FQ-WN005		FQ-WD005
10 m		FQ-WN010		FQ-WD010
20 m		FQ-WN020		FQ-WD020

# V400-R2 Multi Code Reader

Quick Link

D324

omron247.com

## Ultra-Small Linear and 2D Code Reader

- Improves machine cycle time
- Reads moving objects at up to 500 m/min
- Stable reading of imperfect codes
- Aiming feature (Green LED) to quickly position the scanning area for code recognition
- Long and short distance types available for flexible installation



## Ordering Information

Type	Description	Model
Multi Code Reader	Working distance 65 mm	V400-R2CF65
	Working distance 125 mm	V400-R2CF125
OMRON PLC connecting cable	D-sub 9-pin, 0.8 m	V509-W011
	D-sub 9-pin, 5 m	V509-W016
PC/AT Connecting Cable	D-sub 9-pin, 0.8 m	V509-W011D
	D-sub 9-pin, 5 m	V509-W016D

# V500-R2 Linear Code Reader

Quick Link

D326

omron247.com

## Small Size Bar Code Reader That Fits Essentially Everywhere

- High-speed reading at 1,000 scans/second
- Enables reading imperfect codes
- Resists ambient light interference
- Long range up to 270 mm
- Reading test switch provided

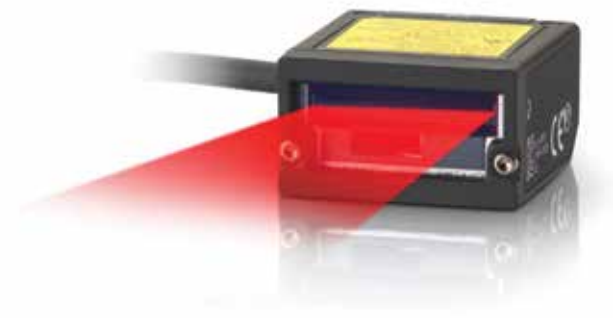

## Ordering Information

Type	Description	Model
Laser-type Code Reader		V500-R2CF
OMRON PLC connecting cable	D-sub 9-pin, 0.8 m	V509-W011
	D-sub 9-pin, 5 m	V509-W016
PC/AT Connecting Cable	D-sub 9-pin, 0.8 m	V509-W011D
	D-sub 9-pin, 5 m	V509-W016D

S

## All-in-One RFID System: Antenna, Amplifier and Controller

- ISO/IEC 18000-3 (15693) compliance
- Built-in Ethernet (TCP/IP; Modbus TCP) for easy connection with one cable
- Easy installation and 4-way visible status indication minimizes startup and downtime
- Set, monitor and communicate with RF tags using a web browser
- Wide line-up of long-life ID tags, with capacities from 1 to 8 Kbytes
- For easy expansion, Ethernet switching hubs (W4S1) connect multiple ID controllers to a PLC



## Ordering Information

### ID Controllers

Type	Operating Frequency	Size	Communications	Model
Reader/Writer and Controller in one	HF-13.56 MHz	50 x 50 x 30 mm	Ethernet (TCP/IP)	V680S-HMD63-ETN
			EtherNet/IP	V680S-HMD63-EIP
			PROFINET	V680S-HMD63-PNT
		75 x 75 x 40 mm	TCP/IP; Modbus TCP	V680S-HMD64-ETN
			EtherNet/IP	V680S-HMD64-EIP
			PROFINET	V680S-HMD64-PNT
		120 x 120 x 40 mm	TCP/IP; Modbus TCP	V680S-HMD66-ETN
			EtherNet/IP	V680S-HMD66-EIP
			PROFINET	V680S-HMD66-PNT

### Cables

Type	Cable Length	Model	
		Special connector - RJ45	Special connector - Loose wires
Connects ID controller to PLC or Ethernet switching hub	2 m	V680S-A41 2M	V680S-A42 2M
	5 m	V680S-A41 5M	V680S-A42 5M
	10 m	V680S-A41 10M	V680S-A42 10M

Type	Cable Length	Model
Extension cable with two special connectors	10 m	V680S-A40 10M
	20 m	V680S-A40 20M
	50 m	V680S-A40 50M

### RF Tags – Battery-less

Type	Memory Capacity	Size	Metallic compatibility	Model
Cylindrical	1 kbytes	20 dia. x 27 mm	Flush mounts on nonmetallic surface	V680-D1KP54T
Square	1 kbytes	34 x 34 x 3.5 mm	Flush mounts on metallic surface	V680-D1KP66MT
	1 kbytes		Flush mounts on nonmetallic surface	V680-D1KP66T
PFA sleeve	1 kbytes	95 x 36.5 x 6.5 mm	Flush mounts on nonmetallic surface	V680-D1KP66T-SP
High-temperature	1 kbytes	80 dia. x 10 mm	Mounts with special attachment	V680-D1KP58HTN
Square	2 kbytes	40 x 40 x 4.5 mm	Flush mounts on metallic surface	V680-D1KF67MN
	2 kbytes		Flush mounts on nonmetallic surface	V680-D1KF67N
Rectangular	2 kbytes	86 x 54 x 5 mm	Flush mounts on metallic surface	V680-D1KF68MN
	2 kbytes		Flush mounts on nonmetallic surface	V680-D1KF68N
Square	8 kbytes	40 x 40 x 4.5 mm	Flush mounts on metallic surface	V680-D1KF67M
	8 kbytes		Flush mounts on nonmetallic surface	V680-D1KF67
Rectangular	8 kbytes	86 x 54 x 5 mm	Flush mounts on nonmetallic surface	V680-D1KF68A

## RFID Systems with ISO/ IEC 18000-3 (ISO/IEC 15693) Compliance

- High-speed, 27 kbps transmission (response-only speed of 53 kbps from the V680-D□KF68)
- Read/write antennas and ID tags with excellent environmental resistance
- Wide line-up of ultra-compact, long-life ID tags, with capacities from 1 to 32 Kbytes
- Seven software modes make it possible to visualize data transmission



- ID Map Manager simplifies memory map designing for ID tags
- Complies with FCC Standards and R&TTE Directive

## Ordering Information

### ID Controllers

Type	Appearance	Connected ID system	External power supply	PLC unit count	Model
Standalone ID controller RS-232C		1 head	DC	-	V680-CA5D01-V2
		2 head		-	V680-CA5D02-V2
CJ-series PLC-based controller		1 head		1	CJ1W-V680C11
		2 head		2	CJ1W-V680C12
CS-series PLC-based controller		1 head		1	CS1W-V680C11
		2 head		2	CS1W-V680C12

### Hand-held Reader/Writer

Type	Appearance	Transmission interface	Power supply	Cable length	Model
Hand-held Wand Interface to PC		USB	5 VDC ±5%	0.8 m	V680-CHUD 0.8M
				1.9 m	V680-CHUD 1.9M
		RS-232C	5 VDC ±5%	0.8 m	V680-CH1D 2.5M
				AC adapter 5 VDC from 115 VAC supply outlet	2 m
Hand-held Wand Interface to Portable PC		RS-232C	5 VDC ±5%	0.8 m	V680-CH1D-PSI
Portable PC for Hand-held Wand		Serial Bluetooth	3.7 V battery pack	-	V680-A-7527S-G3-EG-S

**Accessories** See product literature for antenna and tag listings.

# V680-HAM42-DRT

## Industrial RFID Systems Sensors

Quick Link

D426

omron247.com

### V680-Series DeviceNet-Compatible Slaves for RFID Systems

- V680-series DeviceNet-compatible slaves for RFID systems
- Includes a built-in amplifier, yet has a compact size of 65 x 65 x 65 mm; compatible with V680-series ID Tags and Antennas
- Read and write 4, 26, or 58 bytes of data
- Includes an Access Mode that is compatible with the V600-HAM42-DRT to enable the use of existing programs
- Complies with international standards, including CE, UL/CSA, and radio wave regulations. (Radio wave regulation compliance is applicable to Japan, Europe, the U.S.A., and Canada. Radio wave regulation compliance for China and South Korea is pending)
- Approval for UL/CSA is pending



# V680-HAM91/-HAM81

## Flag Sensors

Quick Link

D525

omron247.com

### RFID System can be Used Just Like a Sensor

Easy to set up V680-HAM91/81 ID Flag sensors read and write 16 bits of data with just one unit. Use them in applications from simple product identification to managing work-in-progress.

- Read or write 16 bits of data (for up to 64,000 IDs) with one unit despite its compact size
- Read or write up to 128 bits by using the address shift function
- NPN and PNP output models
- Uses V680-series tags and antennas
- Accesses existing V600-HAM/HAR programs
- Complies with international standards CE, UL/CSA



- Radio wave regulation compliance applies to Japan, Europe, U.S.A., and Canada; compliance is pending for China and South Korea

## Reliable Antenna and Controller Reads TIRIS Tags

- Read/write data embedded in TIRIS tags (Texas Instruments 32-mm Glass Multipage Transponder model RI-TRP-DR2B) at 134 kHz
- V640 antenna and controller offer better repeatability, distance and reliability than OEM parts
- Conforms to carrier reader/writer-related SEMI standards; SEMI E99, E4, and E5
- Antenna dimensions conform to SEMI E15.1
- Noise measurement function for detecting proper placement of antenna
- Shielded antenna reduces influence of surrounding metal
- Sustain productive uptime: Use an ID Link Unit (V700-L11) to keep the CIDRW system turned ON while the amplifier unit



is removed/installed due to malfunction or during maintenance

- Compatible with SECS communications protocol (CIDRW Controller V700-L22)
- Track FOUPs (Front-Opening Unified Pods), reticles, and pods moving through fabrication
- CE marking/FCC approvals

## Ordering Information

Product	Description	Dimensions (H x W x D)	Model
CIDRW head	2-meter cable	30 x 50 x 12 mm (including mounting plate)	V640-HS61
Amplifier unit	RS-232C interface, RS-485 interface 24 VDC	185 x 80 x 43 mm	V640-HAM11-V3
	Ethernet interface 24 VDC	185 x 80 x 43 mm	V640-HAM11-ETN
CIDRW controller	24 VDC; RS-232C interface (compatible with SECS I/II protocol)	167 x 150 x 28 mm	V700-L22
ID link unit	24 VDC; RS-232C interface; RS-485 interface	65 x 110 x 64 mm	V700-L11
Accessories set	Connector accessories for the V640 Amplifier Unit: Power supply connector (1) Power supply connector Pins (3) RS-485 Port connector (1)		V640-A90
ID tag	PBT resin tag stick tag	3.9 mm dia. x 27 mm	V640-D23P□

## Build a CIDRW System Conforming to SEMI Standards

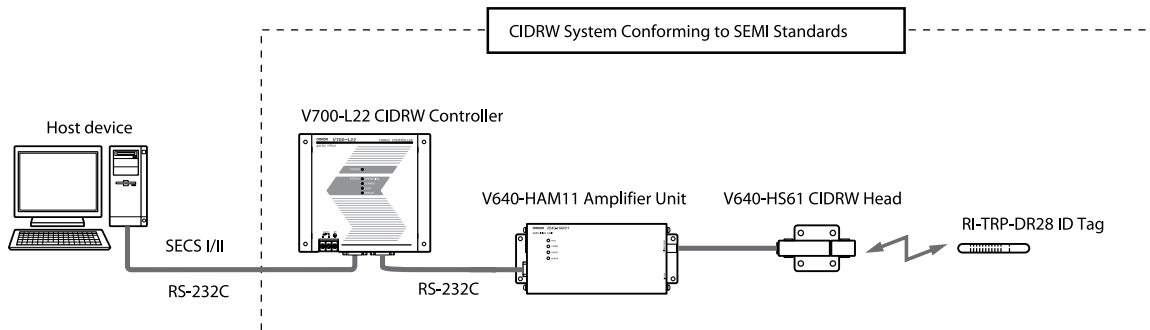

## EPC Gen 2 Interrogator Platform Class 1 for Long-Distance Communication

- Designed to have high read range, quick response and simple operation
- ISO/IEC 18000-6C compliant
- Rich maintenance functions and on-site verification functions
- Self-operation function
- Multiple LED operation displays
- Complies with FCC Standards and R&TTE Directive, UHF 902.75 - 927.75 MHz

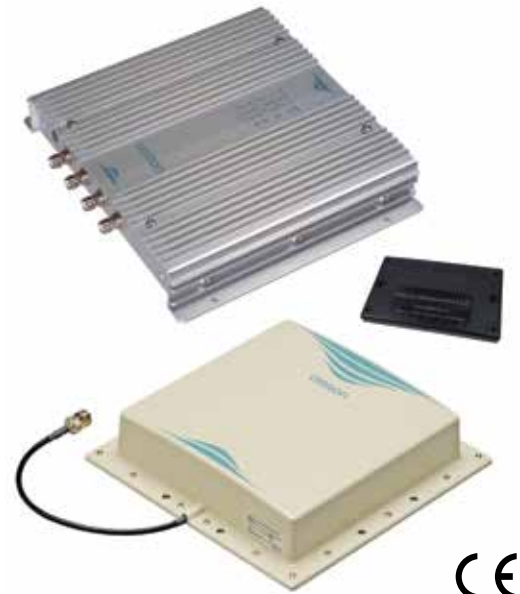

## ID Controllers

No. of Connectable Antennas	Transmission Interface	Power Supply	Dimensions H x W x D mm	Model
Four	Ethernet, RS-232C	DC power supply, includes exclusive AC adapter	246 x 215 x 43.5	V750-BA50C04-US

## Read/Write Head (Antenna)

Read/Write Head Type	Data Carrier Compatibility (See Note 1.)	Connection	Dimensions H x W x D mm	Model
Square type, mono-static antenna (circular)	V750-D04P096-R1 or EPCglobal Class 1, Gen 2 inlay	Standard cable, 0.3 m length, waterproof connector	256 x 256 x 57	V740-HS01CA

## Antenna Extension Cable

Description	Cable Length	Model
Antenna extension cable (See Note 2.)	3 m	V740-A01-3.0M
	10 m	V740-A01-10M
	20 m	V740-A01-20M

## Data Carriers (Tags)

Tag Type	Description	Data Capacity	Dimensions H x W x D mm	Model
Battery-less, EPCglobal Class 1, Gen2 (See Note 1.)	Encapsulated PET tag	96 bytes	30 x 125 x 9	V750-D04P096-R2

Note: 1. The transmission distance may vary based on packaging and application considerations. Refer to the User's Manual (V750: Cat. No. SRFM-012-A) for details.

2. Use an Antenna Cable to connect the Read/Write Antenna to the Controller. The maximum cable length is 10 m.



## Contents

Selection Guide		T-ii
<b>Single-loop Controllers</b>		
E5CB	Basic digital temperature controller	T-1
E5CC	Temperature and process controllers, 1/16 DIN	T-2
E5EC	Temperature and process controllers, 1/8 DIN	T-3
E5AC	Temperature and process controllers, 1/4 DIN	T-4
E5DC	Temperature controllers, socket mounted	T-5
E5CC-U	Temperature controllers, 1/16 DIN, socket mounted	T-6
E5CC-T	Temperature and process controllers, 1/16 DIN, ramp/soak	T-7
E5EC-T	Temperature and process controllers, 1/8 DIN, Ramp/Soak	T-8
E5AC-T	Temperature and process controllers, 1/4 DIN, ramp/soak	T-9
E5GC	Ultra compact temperature controller, 1/32 DIN	T-10
E5CN-H	High-performance digital temperature and process controllers, 1/16 DIN	T-11
E5CN-HT	Ramp/soak temperature and process controllers, 1/16 DIN	T-12
E5AN-H/ E5EN-H	High-performance digital temperature and process controllers, 1/4 and 1/8 DIN	T-13
E5AN-HT/ E5EN-HT	Ramp/soak temperature and process controllers, 1/4 and 1/8 DIN	T-14
E5CSV	Simple-to-use digital temperature controller, 1/16 DIN	T-15
E5C2	Analog set temperature controllers, 1/16 DIN	T-16
K8AK-TH	Temperature monitoring relays, protection against over-temperature	T-17

<b>Multi-loop Controllers</b>		
E5AR/ E5ER	Multi-zone process controller, 1/4 and 1/8 DIN size, panel mount	T-18
E5ZN	Modular multi-zone temperature controller, DIN track mount	T-19
EJ1	Multi-zone temperature & process controller, up to 256 zones, DIN track mount	T-20
<b>Multi-Channel Power Controller</b>		
G3ZA	Multi-Channel Power Controller for EJ1	T-21



## E5CC/EC/AC – HIGH PERFORMANCE WITH SIMPLICITY

### E5CC/E5EC/E5AC – Temperature Controller

Sets new global standards in the crucial areas of precision, user friendliness and control performance.

- High-contrast, white LCD display visible from large distances and from any angle
- Easy to set up without power supply and operate intuitively via CX-Thermo software
- 50 ms sampling period

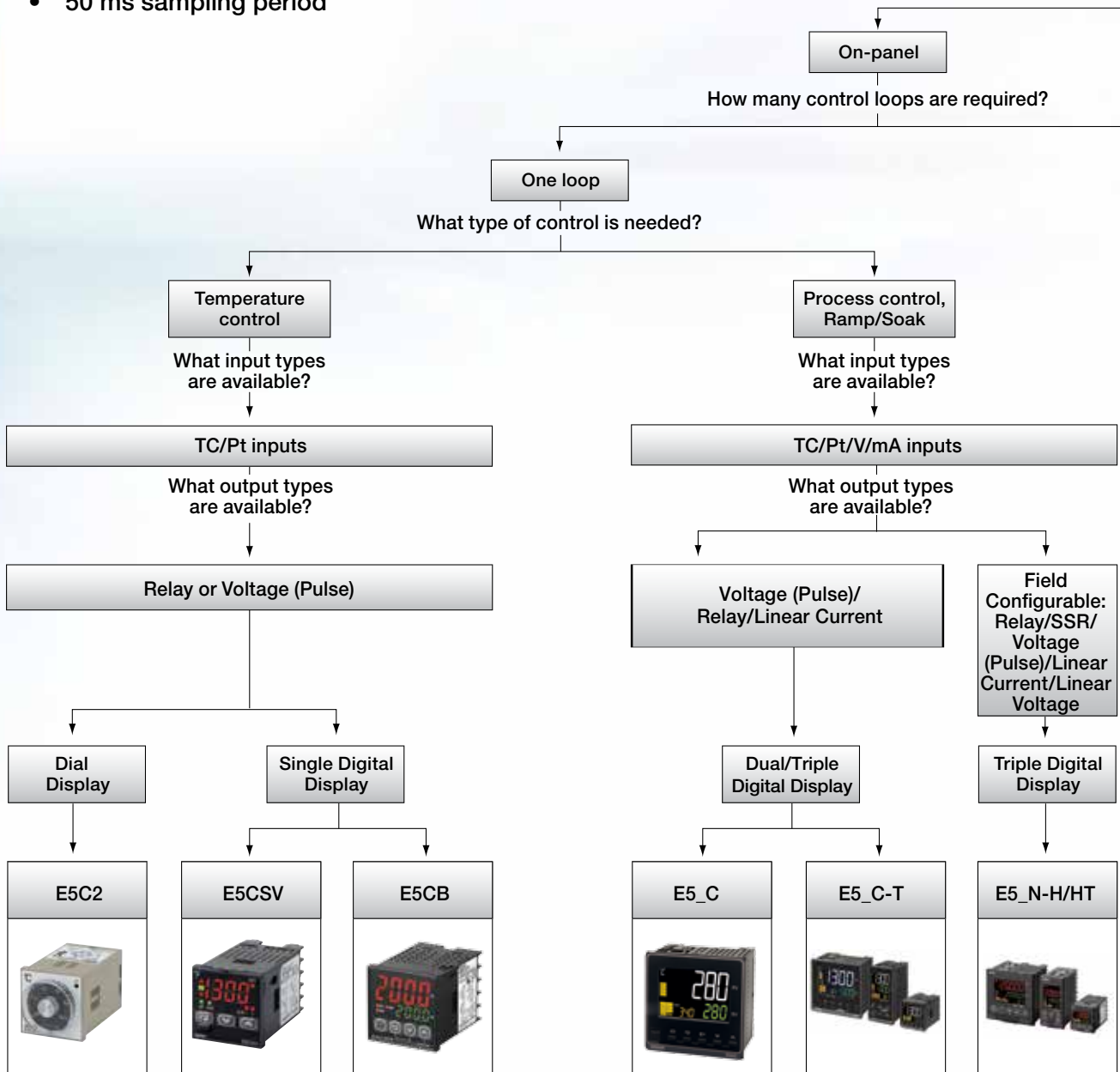



Where will you mount the controller?

In-panel

How many control loops are required?

Multi-loop

What type of control is needed?

Advanced Temp/  
Process Control

What input types  
are available?

TC/Pt/V/mA inputs

What output types  
are available?

Field  
Configurable:  
Relay/Voltage  
(Pulse)/  
Linear  
Current

Dual Digital  
Display

E5\_R



One Loop

What type of control is needed?

Temperature  
Control

What input types  
are available?

TC/Pt/V/mA inputs

What output types  
are available?

Relay/Voltage  
(pulse)/  
Linear  
Current

Dual Digital  
Display

E5DC



Temperature  
Monitor

What input types  
are available?

TC/Pt inputs

What output types  
are available?

Relay

No  
Display

K8AK-TH



Multi-loop

What type of control is needed?

Temp/Process  
control

What input types are available?

TC/mV or Pt inputs

What output types are available?

Voltage (pulse)/  
Transistor/  
Linear Current

What type of display is available?

Optional  
display

E5ZN



Advanced Temp/  
Process control

What input types are available?

TC/Pt/V/mA inputs

What output types are available?





Voltage (pulse)/  
Current/Transistor

No display

EJ1



# Selection Table

Category		Temperature	Analog Temperature Controller	Compact Digital Temperature Controller	Digital Temperature Controller
					
Selection criteria	Model	<b>K8AK-TH</b>	<b>E5C2</b>	<b>E5CSV</b>	<b>E5GN</b>
	Type	Basic	Basic	Basic	General purpose
	Panel	DIN rail	In- & on-panel type	On-panel type	On-panel type
	Loops	Single loop	Single loop	Single loop	Single loop
	Size	22.5 w x 90 h x 100 w	1/16 DIN	1/16 DIN	1/32 DIN
Control mode	ON/OFF	■	■	■	■
	PID	–	■ <sup>*1</sup>	–	–
	2-PID <sup>*2</sup>	■	–	■	■
	Operation	Heating & Cooling	Heating	Heating & Cooling	Heating & Cooling
	Valve control <sup>*3</sup>	–	–	–	–
Features	Accuracy	Type K, J, T, E, B, R, S Thermocouple	±2%	±.05%	±0.3%
	Auto-tuning	Pt100, Pt1000 RTD	–	■	■
	Self-tuning	–	–	■	■
	Transfer output	100-240 VAC	–	–	□
	Remote input	24 VAC/DC	–	–	–
	Number of alarms	–	–	Up to 2	2
	Heater alarm	–	–	–	□
	IP rating front panel	IP20	IP20	IP66; NEMA 4X	IP66; NEMA 4X
	Display	–	SV analog dial	Single 3.5 digit	Dual 4 digit (color change)
Supply voltage	110/240 VAC	■	■	■	■
	24 VAC/VDC	■	–	□	□
Comms <sup>*5</sup>	RS-485	–	–	–	□
	Event IP	–	–	–	□
	Quick Link Port port <sup>*6</sup>	–	–	–	■
	DeviceNet	–	–	–	–
	Modbus	–	–	–	■
Control output	Relay	–	■	■	■
	SSR	–	–	–	–
	Voltage (pulse)	–	■	■	■
	Linear voltage	–	–	–	–
	Linear current	–	–	–	–
Input type – linear	mA	–	–	–	□
	mV	–	–	–	■
	V	–	–	–	□
Input type – thermocouple	K	■	■	■	■
	J	■	–	■	■
	T	■	–	■	■
	E	■	–	–	■
	L	–	■	■	■
	U	–	–	■	■
	N	–	–	■	■
	R	■	–	■	■
	S	■	–	–	■
	B	–	–	–	■
	W	–	–	–	■
	PLII	■	–	–	■
	Input type – RTD	Pt100	■	■	■
JPt100		–	–	■	■
Themistor		–	■	□	–

■ Standard    □ Available    – No/not available





\*1 P only

\*2 2-PID is Omron's easy to use high performance PID algorithm

\*3 Valve control = relay up and down

\*4 Heater alarm = heater burnout & SSR failure detection

# Temperature Controllers

Category		Digital Temperature Controller/Process Controller			
					
Selection criteria	Model	E5CC/E5EC/E5AC	E5 C-T	E5DC	E5CC-U
	Type	General purpose	Ramp soak	General purpose	General purpose
	Panel	On-panel type	On-panel type	In-panel or On-panel	In-panel or On-panel
	Loops	Single loop	Single loop	Single loop	Single loop
Control mode	Size	1/16 DIN	1/4, 1/8, 1/16 DIN	22.5 mm wide	1/16 DIN
	ON/OFF	■	■	■	■
	PID	□	–	–	–
	2-PID <sup>*2</sup>	■	■	■	■
Features	Operation	Heating/Cooling	Heating/Cooling	Heating/Cooling	Heating/Cooling
	Valve control <sup>*3</sup>	–	□	□	–
	Accuracy	±0.3%	±0.3%	±0.3%	±0.3%
	Auto-tuning	■	■	■	■
Supply voltage	Self-tuning	■	■	■	■
	Transfer output	■	■	■	–
	Remote input	■	■	■	–
	Number of alarms	3	3 or 4	2	0, 1 or 2
Comms <sup>*5</sup>	Heater alarm	■	■	■	–
	IP rating front panel	IP66, NEMA 4X	IP66, NEMA 4X	IP20, NEMA 1	IP66, NEMA 4X
	Display	Dual or Triple Display	Dual or Triple Display	Dual Display	Dual Display
	110/240 VAC	■	■	■	■
Control output	24 VAC/VDC	■	■	■	■
	RS-485	■	■	■	–
	Event IP	■	■	■	–
	Quick Link Port port <sup>*6</sup>	■	■	■	■
Input type – linear	DeviceNet	–	–	–	–
	Modbus	■	■	■	–
	Relay	■	■	■	■
	Voltage (pulse)	■	■	■	■
Input type – thermocouple	Linear voltage	■	■	■	■
	Linear current	■	■	■	■
	mA	■	■	■	■
	mV	■	■	■	■
	K	■	■	■	■
	J	■	■	■	■
	T	■	■	■	■
	E	■	■	■	■
	L	■	■	■	■
	U	■	■	■	■
	N	■	■	■	■
	R	■	■	■	■
Input type – RTD	S	■	■	■	■
	B	■	■	■	■
	W	■	■	■	■
	PLII	■	■	■	■
Input type – RTD	Pt100	■	■	■	■
	JPt100	■	■	■	■
	Thermistor	–	–	–	–



■ Standard    □ Available    – No/not available

\*5 PROFIBUS-DP communication option via PRT1-SCU11 for E5\_N(-H), E5\_R, EJ1

\*6 QLP: Quick Link Port to connected TC to PC using the smart USB cable E58-CIFQ1



# Selection Table

Category				
				
Selection criteria	Model	E5_N-H	EJ1	E5ZN
	Type	Universal	Modular	Modular
	Panel	On-panel type	In-panel type	In-panel type
	Loops	Single loop	Multi-loop	Multi-loop
	Size	1/4, 1/8, 1/16 DIN	31 x 96 mm	22.5 mm wide
Control mode	ON/OFF	■	■	■
	PID	—	—	—
	2-PID *2	■	■	■
	Operation	Heating & Cooling	Heating and cooling	Heating and cooling
Valve control *3	□	—	—	
Features	Accuracy	±0.1%	±0.5%	±0.5%
	Auto-tuning	■	■	■
	Self-tuning	■	■	—
	Transfer output	□	□	■
	Remote input	□	—	■
	Number of alarms	3	4	2
	Heater alarm □*4	□*4	□*4	□
	IP rating front panel	IP66; NEMA 4X	—	—
	Display	Dual or Triple Display	—	□
Supply voltage	110/240 VAC	■	—	—
	24 VAC/VDC	□	■	■
Comms <sup>5</sup>	RS-232	□	■	—
	RS-485	□	■	■
	Event IP	□	■	—
	Quick Link Port port <sup>6</sup>	■	■	—
	DeviceNet	—	□	□
	Modbus	■	■	—
Control output	Relay	■	—	—
	SSR	□	—	■
	Voltage (pulse)	■	■	—
	Linear voltage	■	—	■
	Linear current	■	■	■
Input type – linear	mA	■	■	—
	mV	■	■	0-50
	V	■	■	—
Input type – thermocouple	K	■	■	■
	J	■	■	■
	T	■	■	■
	E	■	■	■
	L	■	■	■
	U	■	■	■
	N	■	■	■
	R	■	■	■
	S	■	■	■
	B	■	■	■
	W	■	■	—
	PLII	■	■	—
Input type – RTD	Pt100	■	■	■
	JPt100	■	■	■
	Themistor	—	—	—

■ Standard □ Available — No/not available



\*1 P only

\*2 2-PID is Omron's easy to use high performance PID algorithm

\*3 Valve control = relay up and down

\*4 Heater alarm = heater burnout & SSR failure detection

# Temperature Controllers

Category		Advanced Temperature/Digital Process Controllers		
				
Selection criteria	Model	<b>E5_N-HT</b>	<b>E5AR</b>	<b>E5ER</b>
	Type	Universal, Ramp/Soak	Advanced	Advanced
	Panel	On-panel type	On-panel type	On-panel type
	Loops	Single loop	Multi-loop	Multi-loop
	Size	1/4, 1/8, 1/16 DIN	1/4 DIN	1/8 DIN
Control mode	ON/OFF	■	■	■
	PID	–	–	–
	2-PID <sup>*2</sup>	■	■	■
	Operation	Heating & Cooling	Heating & Cooling	Heating & Cooling
Features	Valve Control <sup>*3</sup>	□	■	■
	Accuracy	±0.1%	±0.1%	±0.1%
	Auto-tuning	■	■	■
	Self-tuning	■	–	–
	Transfer output	□	■	■
	Remote input	□	■	■
	Number of alarms	2 or 3	4	4
	Heater alarm	□	–	–
	IP rating front panel	IP66; NEMA 4X	IP66; NEMA 4X	IP66; NEMA 4X
	Display	Dual 4 digit	Triple 5 digit	Triple 5 digit
Supply voltage	110/240 VAC	■	■	■
	24 VAC/VDC	□	□	□
Comms <sup>5</sup>	RS-232	□	–	–
	RS-485	□	□	□
	Event IP	□	■	■
	Quick Link port <sup>6</sup>	■	■	■
	DeviceNet	–	□	□
	Modbus	■	■	■
Control output	Relay	■	■	■
	SSR	■	–	–
	Voltage (pulse)	■	■	■
	Linear voltage	■	–	–
Input type – linear	Linear current	■	■	■
	mA	■	■	■
	mV	–	–	–
Input type – thermocouple	V	■	■	■
	K	■	■	■
	J	■	■	■
	T	■	■	■
	E	■	■	■
	L	■	■	■
	U	■	■	■
	N	■	■	■
	R	■	■	■
	S	■	■	■
	B	■	■	■
	W	■	■	■
	PLII	■	–	–
Input type – RTD	Pt100	■	■	■
	JPt100	■	–	–
	Themistor	–	–	–

■ Standard    □ Available    – No/not available

\*2 2-PID is Omron's easy to use high performance PID algorithm

\*3 Valve control = relay up and down

\*5 PROFIBUS-DP communication option via PRT1-SCU11 for E5\_N(-H), E5\_R, EJ1

\*6 QLP: Quick Link port to connected TC to PC using the smart USB cable E58-CIFQ1



# Temperature Controllers

---



## 1/16 DIN Size Basic Temperature Controller with Easy to Read Large Digital Display

- Easy-to-read large character display
- Improved visibility with character height of approx. 16 mm
- Depth beyond front panel: only 60 mm
- Fewer parameters for simple setup
- Fast sampling at 250 ms
- Easy to set up without power supply and operate intuitively with CX-Thermo software



## Specifications

- Universal Inputs:
  - Thermocouple input Type: K, J, T, R, or S
  - RTD Input Type: Pt100
- Accuracy:
  - Thermocouple: +/-0.5% of indicated value of +/- 1°C, which ever is greater
  - RTD: +/-0.5% of indicated value of +/- 1°C, which ever is greater
- Control Output:
  - Relay Output: SPST-NO 250 VAC 3 A
  - Output Voltage: 12 VDC +25%/-15%. Max load current 21 mA with short circuit protection

## Temperature Controllers

Size	Power supply voltage	Input type	Alarm output	Control output	Model
48 x 48 mm	100 to 240 VAC	Thermocouple	1	Relay output	E5CB-R1TC
		Platinum resistance thermometer			E5CB-R1P
		Thermocouple		Voltage output (for driving SSR)	E5CB-Q1TC
	24 VAC/VDC	Platinum resistance thermometer		E5CB-Q1P	
		Thermocouple		Relay output	E5CB-R1TCD
		Platinum resistance thermometer		E5CB-R1PD	
		Thermocouple		Voltage output (for driving SSR)	E5CB-Q1TCD
		Platinum resistance thermometer		E5CB-Q1PD	

## 1/16 DIN Size Temperature & Process Controllers with High Visibility Display

- Fast and precise regulation: 50 ms sampling loop period time
- Easy to set up without power supply and operate intuitively via CX-Thermo software
- High-contrast, white LCD display visible from a far distance and from any angle (PV: 15.2 H mm)
- Useful alarm and diagnostic functions for secure operation
- Compact short body depth: 48 H x 48 W x 60 D mm



## Specifications

- Universal Inputs:
  - Thermocouple: Types K, J, T, E, L, U, N, R, S, B, W, or PL II
  - Platinum RTD: Pt100 or JPt100
  - Infrared temperature sensor: 10°-70°C, 60°-120°C, 115° -165°C, 160°-260°C
  - Current: 4 to 20 mA or 0 to 20 mA
  - Voltage: 1 to 5 V, 0 to 5 V, or 0 to 10
- Accuracy:
  - Thermocouple: ( $\pm 0.3\%$  of indicated value or  $\pm 1^\circ\text{C}$ , whichever is greater)  $\pm 1$  digit max.
  - Platinum RTD: ( $\pm 0.2\%$  of indicated value or  $\pm 0.8^\circ\text{C}$ , whichever is greater)  $\pm 1$  digit
  - Analog:  $\pm 0.2\%$  FS  $\pm 1$  digit max.
- Control output:
  - Relay Output: SPST-NO, 250 VAC, 3 A (resistive load)
  - Voltage (pulse) Output: 12 VDC  $\pm 20\%$  (PNP), max. load current: 21 mA, with short-circuit protection circuit
  - Current Output: 4 to 20 mA DC/0 to 20 mA DC, load: 500  $\Omega$  max., resolution: approx. 10,000
- Front Panel Rating: NEMA 4X / IP66

## Ordering Information

Input	Output	Fixed option	Alarms	Model: AC110-240V	Model: AC/DC24V	
Temp. & Analog	Out1: Relay	---	3 relays	E5CC-RX3A5M-000	E5CC-RX3D5M-000	
		Event Input 2, Transfer output		E5CC-RX3A5M-006	E5CC-RX3D5M-006	
		Event Input 2, Remote SP		E5CC-RX3A5M-007	E5CC-RX3D5M-007	
	Out1: Voltage (pulse)	---		E5CC-QX3A5M-000	E5CC-QX3D5M-000	
		Event Input 2, Heater Burnout SSR defect detection		E5CC-QX3A5M-001	E5CC-QX3D5M-001	
		Communication 3-phase heater alarm		E5CC-QX3A5M-003	E5CC-QX3D5M-003	
		Event Input 2, Transfer output		E5CC-QX3A5M-006	E5CC-QX3D5M-006	
		Event Input 2, Remote SP		E5CC-QX3A5M-007	E5CC-QX3D5M-007	
		---		E5CC-QQ3A5M-000	E5CC-QQ3D5M-000	
	Temp. & Analog	Out1: Voltage (pulse)		---	E5CC-QQ3A5M-001	E5CC-QQ3D5M-001
				Event Input 2, Heater Burnout SSR defect detection	E5CC-QQ3A5M-000	E5CC-QQ3D5M-000
				---	E5CC-CX3A5M-000	E5CC-CX3D5M-000
Out1: Linear current		---	E5CC-CX3A5M-006	E5CC-CX3D5M-006		
		Event Input 2, Transfer output	E5CC-CX3A5M-007	E5CC-CX3D5M-007		
		Event Input 2, Remote SP	E5CC-CX3A5M-000	E5CC-CX3D5M-000		

## 1/8 DIN Size Temperature and Process Controllers with High Visibility Display

- Fast and precise regulation: 50 ms sampling loop period time
- Easy to set up without power supply and operate intuitively via CX-Thermo software
- High-contrast, white LCD display visible from a far distance and from any angle (PV: 18 H mm)
- Useful alarm and diagnostic functions for secure operation
- Compact short body depth: 96 H x 48 W x 60 D mm



## Specifications

- Universal Inputs:
  - Thermocouple: Types K, J, T, E, L, U, N, R, S, B, W, or PL II
  - Platinum RTD: Pt100 or JPt100
  - Infrared temperature sensor: 10°-70°C, 60°-120°C, 115° -165°C, 160°-260°C
  - Current: 4 to 20 mA or 0 to 20 mA
  - Voltage: 1 to 5 V, 0 to 5 V, or 0 to 10
- Accuracy:
  - Thermocouple: ( $\pm 0.3\%$  of indicated value or  $\pm 1^\circ\text{C}$ , whichever is greater)  $\pm 1$  digit max.
  - Platinum RTD: ( $\pm 0.2\%$  of indicated value or  $\pm 0.8^\circ\text{C}$ , whichever is greater)  $\pm 1$  digit
  - Analog:  $\pm 0.2\%$  FS  $\pm 1$  digit max.
- Control output:
  - Relay Output: SPST-NO, 250 VAC, 3 A (resistive load)
  - Voltage (pulse) Output: 12 VDC  $\pm 20\%$  (PNP), max. load current: 21 mA, with short-circuit protection circuit
  - Current Output: 4 to 20 mA DC/0 to 20 mA DC, load: 500  $\Omega$  max., resolution: approx. 10,000
- Front Panel Rating: NEMA 4X / IP66

## Ordering Information

Input	Output	Fixed option	Alarms	Order code (48 x 96 mm model)	
				AC110-240V	AC/DC24V
Temp. & Analog	Out1: Relay Out2: none	---	4 relays	E5EC-RX4A5M-000	E5EC-RX4D5M-000
		Event Input 2, Communication 3-phase heater alarm		E5EC-RX4A5M-009	E5EC-RX4D5M-009
		Event Input 4 Heater Burnout SSR defect detection		E5EC-RX4A5M-010	E5EC-RX4D5M-010
		Event Input 6, Remote SP Heater Burnout SSR defect detection Transfer output		E5EC-RX4A5M-011	E5EC-RX4D5M-011
	Out1: Relay Out2: Relay	---		E5EC-RR4A5M-000	E5EC-RR4D5M-000
		Event Input 2, Communication 3-phase heater alarm		E5EC-RR4A5M-009	E5EC-RR4D5M-009
		Event Input 4 Heater Burnout SSR defect detection		E5EC-RR4A5M-010	E5EC-RR4D5M-010
		Event Input 6, Remote SP Heater Burnout SSR defect detection Transfer output		E5EC-RR4A5M-011	E5EC-RR4D5M-011

## 1/4 DIN Size Temperature and process controllers with High Visibility Display

- Fast and precise regulation: 50 ms sampling loop period time
- Easy to setup without power supply and operate intuitively via CX-Thermo software
- High-contrast, white LCD display visible from a far distance and from any angle (PV:18 H mm)
- Useful alarm and diagnostic functions for secure operation
- Compact short body depth: 96 H x 96 W x 64 D mm



## Specifications

- **Universal Inputs:**
  - Thermocouple: Types K, J, T, E, L, U, N, R, S, B, W, or PL II
  - Platinum RTD: Pt100 or JPt100
  - Infrared temperature sensor: 10°-70°C, 60°-120°C, 115°-165°C, 160°-260°C
  - Current: 4 to 20 mA or 0 to 20 mA
  - Voltage: 1 to 5 V, 0 to 5 V, or 0 to 10 V
- **Accuracy:**
  - Thermocouple: ( $\pm 0.3\%$  of indicated value or  $\pm 1^\circ\text{C}$ , whichever is greater)  $\pm 1$  digit max.
  - Platinum RTD: ( $\pm 0.2\%$  of indicated value or  $\pm 0.8^\circ\text{C}$ , whichever is greater)  $\pm 1$  digit
  - Analog:  $\pm 0.2\%$  FS  $\pm 1$  digit max
- **Control Output:**
  - Relay Output, SPST-NO, 250 VAC, 5 A (resistive load)
  - Voltage (pulse) Output: 12 VDC  $\pm 20\%$  (PNP), max. load current: 21 mA, with short-circuit protection circuit
  - Current Output: 4 to 20 mA DC / 0 to 20 mA DC, Load: 500 $\Omega$  max., resolution approx. 10,000
- Front Panel Rating: NEMA 4X / IP66

## Ordering Information

Input	Output	Fixed option	Alarms	Order code (96 x 96 mm model)	
				AC110-240V	AC/DC24V
Temp. & Analog	Out1: Relay	---	4	E5AC-RX4A5M-000	E5AC-RX4D5M-000
	Out2: none	Event Input 2, Communication 3-phase heater alarm		E5AC-RX4A5M-009	E5AC-RX4D5M-009
		Event Input 4, Heater Burnout SSR defect detection		E5AC-RX4A5M-010	E5AC-RX4D5M-010
		Remote SP Heater Burnout SSR defect detection, Transfer output		E5AC-RX4A5M-011	E5AC-RX4D5M-011
	Out1: Relay	---		E5AC-RR4A5M-000	E5AC-RR4D5M-000
	Out2: Relay	Event Input 2, Communication 3-phase heater alarm		E5AC-RR4A5M-009	E5AC-RR4D5M-009
		Event Input 4, Heater Burnout SSR defect detection		E5AC-RR4A5M-010	E5AC-RR4D5M-010
		Remote SP Heater Burnout SSR defect detection, Transfer output		E5AC-RR4A5M-011	E5AC-RR4D5M-011

## Socket Mounted Temperature Controllers with High Visibility Display

- Fast and precise regulation: 50 ms sampling loop period
- Space saving size 85 x 22.5 mm (D x W) DIN rail mountable
- Removable terminal block for easy replacement
- Easy to setup without power supply and operate intuitively via CX-Thermo software
- High-contrast, white LCD display visible from far distances and from any angle (PV: 8.5 mm (H) )
- Compact short body depth: 85 H x 22.5 W x 60 D mm



## Specifications

- Universal Inputs:
  - Thermocouple: Types K, J, T, E, L, U, N, R, S, B, W, or PL II
  - Platinum RTD: Pt100 or JPt100
  - Infrared temperature sensor: 10°-70°C, 60°-120°C, 115°-165°C, 160°-260°C
  - Current: 4 to 20 mA or 0 to 20 mA
  - Voltage: 1 to 5 V, 0 to 5 V, or 0 to 10 V

- Accuracy:
  - Thermocouple: ( $\pm 0.3\%$  of indicated value or  $\pm 1^\circ\text{C}$ , whichever is greater)  $\pm 1$  digit max.
  - Platinum RTD: ( $\pm 0.2\%$  of indicated value or  $\pm 0.8^\circ\text{C}$ , whichever is greater)  $\pm 1$  digit max.
  - Analog:  $\pm 0.2\%$  FS  $\pm 1$  digit max.
- Control Output:
  - Relay Output, SPST-NO, 250 VAC, 3 A (resistive load)
  - Voltage (pulse) Output: 12 VDC  $\pm 20\%$  (PNP), max. load current: 21 mA, with short-circuit protection circuit
  - Current Output: 4 to 20 mA DC / 0 to 20 mA DC, Load: 500 $\Omega$  max., resolution approx. 10,000
- Front Panel Rating: NEMA 1 / IP20

## Ordering Information

Input	Output	Fixed option	Alarms	Model: 100-240 VAC	Model: 24 VAC/VDC
Temp. & Analog	Out 1: Relay	Communication only	0	E5DC-RX0ASM-015	E5DC-RX0DSM-015
		---	2	E5DC-RX2ASM-000	E5DC-RX2DSM-000
		Heater burnout and SSR defect detection, Communication		E5DC-RX2ASM-002	E5DC-RX2DSM-002
		Heater burnout and SSR defect detection, Event input 1		E5DC-RX2ASM-017	E5DC-RX2DSM-017
	Out 1: Voltage (pulse)	Communication only	0	E5DC-QX0ASM-015	E5DC-QX0DSM-015
		---	2	E5DC-QX2ASM-000	E5DC-QX2DSM-000
		Heater burnout and SSR defect detection, Communication		E5DC-QX2ASM-002	E5DC-QX2DSM-002
		Heater burnout and SSR defect detection, Event input 1		E5DC-QX2ASM-017	E5DC-QX2DSM-017
	Out 1: Current	Communication only	0	E5DC-CX0ASM-015	E5DC-CX0DSM-015
		---	2	E5DC-CX2ASM-000	E5DC-CX2DSM-000
		Communication only		E5DC-CX2ASM-015	E5DC-CX2DSM-015
		Event input		E5DC-CX2ASM-016	E5DC-CX2DSM-016

## 1/16 DIN Size Socket Mounted Temperature Controllers, Designed for Simple Installation and Fast Servicing

- Plugs into standard 11-pin round socket
- Fast and precise regulation: 50 ms sampling loop period
- ON/OFF control or 2-PID with auto-tuning for superior performance
- Easy to setup without power supply and operate intuitively via CX-Thermo software
- High-contrast, white LCD display visible (PV: 15.2 mm (H) )
- Fits DIN rail socket P2CF-11 or back mounted socket P3GA-11



## Specifications

- Universal Inputs:
  - Thermocouple: Types K, J, T, E, L, U, N, R, S, B, W, or PL II
  - Platinum RTD: Pt100 or JPt100
  - Infrared temperature sensor: 10°-70°C, 60°-120°C, 115°-165°C, 140°-260°C
  - Current: 4 to 20 mA or 0 to 20 mA
  - Voltage: 1 to 5 V, 0 to 5 V, or 0 to 10 V
- Accuracy:
  - Thermocouple: ( $\pm 0.3\%$  of indicated value or  $\pm 1^\circ\text{C}$ , whichever is greater)  $\pm 1$  digit max.
  - Platinum RTD: ( $\pm 0.2\%$  of indicated value or  $\pm 0.8^\circ\text{C}$ , whichever is greater)  $\pm 1$  digit max.
  - Analog:  $\pm 0.2\%$  FS  $\pm 1$  digit max.
- Control Output:
  - Relay Output, SPST-NO, 250 VAC, 3 A (resistive load)
  - Voltage (pulse) Output: 12 VDC  $\pm 20\%$  (PNP), max. load current: 21 mA, with short-circuit protection circuit
  - Current Output: 4 to 20 mA DC / 0 to 20 mA DC, Load: 500 $\Omega$  max., resolution approx. 10,000
- Front Panel Rating: NEMA 12 / IP50

## Ordering Information

Input	Output	Alarms	Model: 100-240 VAC	Model: 24 VAC/VDC
Temp. & Analog	Out 1: Relay	0	E5CC-RW0AUM-000	E5CC-RW0DUM-000
		1	E5CC-RW1AUM-000	E5CC-RW1DUM-000
		2	E5CC-RW2AUM-000	E5CC-RW2DUM-000
	Out 1: Voltage (pulse)	0	E5CC-QW0AUM-000	E5CC-QW0DUM-000
		1	E5CC-QW1AUM-000	E5CC-QW1DUM-000
		2	E5CC-QW2AUM-000	E5CC-QW2DUM-000
	Out 1: Current	0	E5CC-CW0AUM-000	E5CC-CW0DUM-000
		1	E5CC-CW1AUM-000	E5CC-CW1DUM-000
		2	E5CC-CW2AUM-000	E5CC-CW2DUM-000

## 1/16 DIN Size Ramp/Soak Temperature & Process Controller with High Visibility Display

- Set up to 8 program (patterns) with 32 segments (steps)
- Fast and precise regulation: 50 ms sampling loop period
- High-contrast, white LCD display visible from a far distance and from any angle (PV: 15.2 mm (H))
- Easy to setup without power supply and operate intuitively via CX-Thermo software



- Compact short body depth: 48 H x 48 W x 60 D mm
- Accuracy:
  - Thermocouple: ( $\pm 0.3\%$  of indicated value or  $\pm 1^\circ\text{C}$ , whichever is greater)  $\pm 1$  digit max.
  - Platinum RTD: ( $\pm 0.2\%$  of indicated value or  $\pm 0.8^\circ\text{C}$ , whichever is greater)  $\pm 1$  digit max.
  - Analog:  $\pm 0.2\%$  FS+/-1 digit max.
- Control Output:
  - Relay Output, SPST-NO, 250 VAC, 3 A (resistive load)
  - Voltage (pulse) Output: 12 VDC  $\pm 20\%$  (PNP), max. load current: 21 mA, with short-circuit protection circuit
  - Current Output: 4 to 20 mA DC / 0 to 20 mA DC, Load: 500 $\Omega$  max., resolution approx. 10,000
- Front Panel Rating: NEMA 4X / IP66

### Specifications

- Universal Inputs:
  - Thermocouple: Types K, J, T, E, L, U, N, R, S, B, W, or PL II
  - Platinum RTD: Pt100 or JPt100
  - Infrared temperature sensor: 10°-70°C, 60°-120°C, 115°-165°C, 140°-260°C
  - Current: 4 to 20 mA or 0 to 20 mA
  - Voltage: 1 to 5 V, 0 to 5 V, or 0 to 10 V
- Program Control:
  - Number of programs: 8
  - Number of segments: 32
  - Segment times: 0 h 0 min to 99 h 59 min / 0 min 0 s to 99 min 59 s

### Ordering Information

Input	Output	Fixed option	Alarms	Model: 100-240 VAC	Model: 24 VAC/VDC
Temp. & Analog	Out 1: Relay, Out 2: None	---	3	E5CC-TRX3A5M-000	E5CC-TRX3D5M-000
		Heater burnout and SSR defect detection, Event Input 2	3	E5CC-TRX3A5M-001	E5CC-TRX3D5M-001
		Heater burnout and SSR defect detection 2 (3-phase heaters), Communications	3	E5CC-TRX3A5M-003	E5CC-TRX3D5M-003
		Communications, Event input 2	3	E5CC-TRX3A5M-004	E5CC-TRX3D5M-004
		Event Input 4, Transfer output	3	E5CC-TRX3A5M-006	E5CC-TRX3D5M-006
		---	3	E5CC-TQX3A5M-000	E5CC-TQX3D5M-000
	Out 1: Voltage (pulse), Out 2: None	Heater burnout and SSR defect detection, Event Input 2	3	E5CC-TQX3A5M-001	E5CC-TQX3D5M-001
		Heater burnout and SSR defect detection 2 (3-phase heaters), Communications	3	E5CC-TQX3A5M-003	E5CC-TQX3D5M-003
		Communications, Event input 2	3	E5CC-TQX3A5M-004	E5CC-TQX3D5M-004
		Event Input 4, Transfer output	3	E5CC-TQX3A5M-006	E5CC-TQX3D5M-006
		---	3	E5CC-TCX3A5M-000	E5CC-TCX3D5M-000
		Communications, Event input 2	3	E5CC-TCX3A5M-004	E5CC-TCX3D5M-004
Out 1: Current, Out 2: None	---	3	E5CC-TCX3A5M-000	E5CC-TCX3D5M-000	
	Event Input 4, Transfer output	3	E5CC-TCX3A5M-006	E5CC-TCX3D5M-006	

Note: Please reference E5CC-T datasheet for other models and options.

## 1/8 DIN Size Ramp/Soak Temperature & Process Controller with High Visibility Display

- Set up to 8 program (patterns) with 32 segments (steps)
- Fast and precise regulation: 50 ms sampling loop period
- High-contrast, white LCD display visible from a far distance and from any angle (PV: 18 mm (H) )
- Models available with up to 4 auxiliary outputs and up to 6 event inputs and a transfer output
- Easy to setup without power supply and operate intuitively via CX-Thermo software



### Specifications

- Universal Inputs:
  - Thermocouple: Types K, J, T, E, L, U, N, R, S, B, W, or PL II
  - Platinum RTD: Pt100 or JPt100
  - Infrared temperature sensor: 10°-70°C, 60°-120°C, 115°-165°C, 140°-260°C
  - Current: 4 to 20 mA or 0 to 20 mA
  - Voltage: 1 to 5 V, 0 to 5 V, or 0 to 10 V
- Program Control:
  - Number of programs: 8
  - Number of segments: 32
  - Segment times: 0 h 0 min to 99 h 59 min / 0 min 0 s to 99 min 59 s
- Compact short body depth: 96 H x 48 W x 60 D mm
- Accuracy:
  - Thermocouple: ( $\pm 0.3\%$  of indicated value or  $\pm 1^\circ\text{C}$ , whichever is greater)  $\pm 1$  digit max.
  - Platinum RTD: ( $\pm 0.2\%$  of indicated value or  $\pm 0.8^\circ\text{C}$ , whichever is greater)  $\pm 1$  digit max.
  - Analog:  $\pm 0.2\%$  FS+/-1 digit max.
- Control Output:
  - Relay Output, SPST-NO, 250 VAC, 5 A (resistive load)
  - Voltage (pulse) Output: 12 VDC  $\pm 20\%$  (PNP), max. load current: 21 mA, with short-circuit protection circuit
  - Current Output: 4 to 20 mA DC / 0 to 20 mA DC, Load: 500 $\Omega$  max., resolution approx. 10,000

### Ordering Information

- Front Panel Rating: NEMA 4X / IP66

Input	Output	Fixed option	Alarms	Model: 100-240 VAC	Model: 24 VAC/VDC
Temp. & Analog	Out 1: Relay, Out 2: None	---	0	E5EC-TRX4ASM-000	E5EC-TRX4DSM-000
		Heater burnout and SSR defect detection, RS-485	2	E5EC-TRX4ASM-008	E5EC-TRX4DSM-008
		Heater burnout and SSR defect detection, Transfer output	6	E5EC-TRX4ASM-019	E5EC-TRX4DSM-019
	Out 1: Voltage (pulse), Out 2: None	---	0	E5EC-TQX4ASM-000	E5EC-TQX4DSM-000
		Heater burnout and SSR defect detection, RS-485	2	E5EC-TQX4ASM-008	E5EC-TQX4DSM-008
		Heater burnout and SSR defect detection, Transfer output	6	E5EC-TQX4ASM-019	E5EC-TQX4DSM-019
	Out 1: Current, Out 2: None	---	1	E5EC-TCX4ASM-000	E5EC-TCX4DSM-000
		RS-485	2	E5EC-TCX4ASM-004	E5EC-TCX4DSM-004
		Transfer output	6	E5EC-TCX4ASM-021	E5EC-TCX4DSM-021
Transfer output, RS-485		4	E5EC-TCX4ASM-022	E5EC-TCX4DSM-022	

Note: Please reference E5EC-T datasheet for other models and options.



## 1/4 DIN Size Ramp/Soak Temperature & Process Controller with High Visibility Display

- Set up to 8 program (patterns) with 32 segments (steps)
- Fast and precise regulation: 50 ms sampling loop period
- High-contrast, white LCD display visible from a far distance and from any angle (PV: 25 mm (H) )
- Models available with up to 4 auxiliary outputs and up to 6 event inputs and a transfer output
- Easy to setup without power supply and operate intuitively via CX-Thermo software



### Specifications

- Universal Inputs:
  - Thermocouple: Types K, J, T, E, L, U, N, R, S, B, W, or PL II
  - Platinum RTD: Pt100 or JPt100
  - Infrared temperature sensor: 10°-70°C, 60°-120°C, 115°-165°C, 140°-260°C
  - Current: 4 to 20 mA or 0 to 20 mA
  - Voltage: 1 to 5 V, 0 to 5 V, or 0 to 10 V
- Program Control:
  - Number of programs: 8
  - Number of segments: 32
  - Segment times: 0 h 0 min to 99 h 59 min / 0 min 0 s to 99 min 59 s
- Accuracy:
  - Thermocouple: ( $\pm 0.1\%$  of indicated value or  $\pm 10^\circ\text{C}$ , whichever is greater)  $\pm 1$  digit max.
  - Platinum RTD: ( $\pm 0.1\%$  of indicated value or  $\pm 0.2^\circ\text{C}$ , whichever is greater)  $\pm 1$  digit max.
  - Analog:  $\pm 0.1\%$  FS+/-1 digit max.
- Control Output:
  - Relay Output, SPST-NO, 250 VAC, 3 A (resistive load)
  - Voltage (pulse) Output: 12 VDC  $\pm 20\%$  (PNP), max. load current: 21 mA, with short-circuit protection circuit
  - Current Output: 4 to 20 mA DC / 0 to 20 mA DC, Load: 500 $\Omega$  max., resolution approx. 10,000

- Compact short body depth: 96 H x 96 W x 60 D mm

### Ordering Information

- Front Panel Rating: NEMA 4X / IP66

Input	Output	Fixed option	Alarms	Model: 100-240 VAC	Model: 24 VAC/VDC
Temp. & Analog	Out 1: Relay, Out 2: None	---	0	E5AC-TRX4ASM-000	E5AC-TRX4DSM-000
		Heater burnout and SSR defect detection, RS-485	2	E5AC-TRX4ASM-008	E5AC-TRX4DSM-008
		Heater burnout and SSR defect detection, Transfer output	6	E5AC-TRX4ASM-019	E5AC-TRX4DSM-019
	Out 1: Voltage (pulse), Out 2: None	---	0	E5AC-TQX4ASM-000	E5AC-TQX4DSM-000
		Heater burnout and SSR defect detection, RS-485	2	E5AC-TQX4ASM-008	E5AC-TQX4DSM-008
		Heater burnout and SSR defect detection, Transfer output	6	E5AC-TQX4ASM-019	E5AC-TQX4DSM-019
	Out 1: Current, Out 2: None	---	0	E5AC-TCX4ASM-000	E5AC-TCX4DSM-000
		RS-495	2	E5AC-TCX4ASM-004	E5AC-TCX4DSM-004
		Transfer output	6	E5AC-TCX4ASM-021	E5AC-TCX4DSM-021
		Transfer output, Communications	4	E5AC-TCX4ASM-022	E5AC-TCX4DSM-022

Note: Please reference E5AC-T datasheet for other models and options.

## 1/32 DIN Size Temperature and process controllers with Smart Functions

- A compact body of 48 x 24 x 90 mm (W x H x D) that is ideal for small equipment, laboratory instruments, and others.
- White PV display with a height of 10.5 mm for high visibility even with the compact body.
- Removable terminal block to simplify maintenance. Select from screw terminals or screwless clamp terminals for the wiring method.
- High-speed sampling at 50 ms.



- Easy connections to a PLC with programless communications.
- Set up the Controller without wiring the power supply by connecting to the computer with a Communications Conversion Cable (sold separately).
- Setup is easy with the CX-Thermo (sold separately).

## Specifications

- Temperature Input:
  - Thermocouple: K, J, T, E, L, U, N, R, S, B, W, or PL II
  - Platinum resistance thermometer: Pt100 or JPt100
- Infrared temperature sensor (ES1B): 10 to 70°C, 60 to 120°C, 115 to 165°C, or 140 to 260°C
- Analog input:
  - Current input: 4 to 20 mA or 0 to 20 mA
  - Voltage input: 1 to 5 V, 0 to 5 V, or 0 to 10 V
- Indication Accuracy:
  - Thermocouple:  $\pm 1\%$  of indication value of PV
  - Pt input:  $\pm 1\%$  of indication value of PV
  - Analog input:  $\pm 1\%$  FS  $\pm 1$  digit max.
  - CT input:  $\pm 5\%$  FS  $\pm 1$  digit max.

## Ordering Information

Input	Output	Fixed option	Alarms	Model: 100-240 VAC	Model: 24 VAC/VDC
Temp & Analog	Out 1: Relay	---	1	E5GC-RX1A6M-000	E5GC-RX1D6M-000
		---	2	E5GC-RX2A6M-000	E5GC-RX2D6M-000
		Communication only	1	E5GC-RX1A6M-015	E5GC-RX1D6M-015
			2	E5GC-RX2A6M-015	E5GC-RX2D6M-015
		Event input 1	2	E5GC-RX2A6M-016	E5GC-RX2D6M-016
		Heater burnout and SSR defect detection	2	E5GC-RX2A6M-023	E5GC-RX2D6M-023
		1	E5GC-RX1A6M-024	E5GC-RX1D6M-024	
	Out 1: Voltage	---	1	E5GC-QX1A6M-000	E5GC-QX1D6M-000
		---	2	E5GC-QX2A6M-000	E5GC-QX2D6M-000
		Communication only	1	E5GC-QX1A6M-015	E5GC-QX1D6M-015
			2	E5GC-QX2A6M-015	E5GC-QX2D6M-015
		Event Input 1	1	E5GC-QX1A6M-016	E5GC-QX1D6M-016
			2	E5GC-QX2A6M-016	E5GC-QX2D6M-016
		1	E5GC-QX1A6M-023	E5GC-QX1D6M-023	
		2	E5GC-QX2A6M-023	E5GC-QX2D6M-023	
		1	E5GC-QX1A6M-024	E5GC-QX1D6M-024	
	Out 1: Linear	---	1	E5GC-CX1A6M-000	E5GC-CX1D6M-000
		---	2	E5GC-CX2A6M-000	E5GC-CX2D6M-000
		Communication only	1	E5GC-CX1A6M-015	E5GC-CX1D6M-015
			2	E5GC-CX2A6M-015	E5GC-CX2D6M-015
		Event Input 1	1	E5GC-CX1A6M-016	E5GC-CX1D6M-016
			2	E5GC-CX2A6M-016	E5GC-CX2D6M-016
		1	E5GC-CX1A6M-024	E5GC-CX1D6M-024	

## Advanced, High-Performance 1/16 DIN Size Temperature and process controllers

- Easy-to-read, high-resolution, 11-segment display with 5 digits/0.01°C or F
- Achieve high-speed disturbance recovery from 60 ms sampling rate
- Flexible logic operations (AND, OR, and delays) with contact outputs set from CX-Thermo software
- Optional units include event inputs, communications, 1-phase and 3-phase heater burnout, transfer output, and a second control output



## Specifications

- Universal Inputs:
  - Thermocouple: Types K, J, T, L, E, U, N, R, S, B, W, or PL II
  - Platinum RTD input: Pt100 and JPt100
  - Current input: 4-20 mA, 0 to 20 mA
  - Voltage: 1 to 5 V, 0 to 5 V or 0 to 10 V
- Thermocouple: ( $\pm 0.1\%$  of indicated value or  $\pm 1^\circ\text{C}$ , whichever is greater)  $\pm 1$  digit max.
- Platinum RTD: ( $\pm 0.1\%$  of indicated value or  $\pm 0.5^\circ\text{C}$ , whichever is greater)  $\pm 1$  digit max.
- Analog Input:  $\pm 0.1\%$  FS  $\pm 1$  digit max.
- CT input:  $\pm 5\%$  FS  $\pm 1$  digit max.
- Relay Output: SPST-NO, 3 A at 250 VAC
  - 100,000 electrical operations (standard)
- Voltage Output: 12 VDC  $\pm 15\%$  for SSR, 21 mA max. load with short-circuit protection
- Current Output: 4-20 mA DC/0 to 20 mA DC, 600  $\Omega$  max., approx. 10,000 resolution
- Linear Voltage Input: 0 to 10 VDC (load: 1 k $\Omega$  min.), approx. 10,000 resolution

## Temperature and Process Controllers

Supply voltage	Auxiliary outputs	Control outputs	Model (only black models listed)
100-240 VAC, 50/60 Hz	2	Relay (See note)	E5CN-HR2M-500 AC100-240
		Voltage (See note)	E5CN-HQ2M-500 AC100-240
		Current (See note)	E5CN-HC2M-500 AC100-240
		Linear voltage	E5CN-HV2M-500 AC100-240
24 VAC, 50/60 Hz, 24 VDC		Relay (See note)	E5CN-HR2MD-500 ACDC24
		Voltage (See note)	E5CN-HQ2MD-500 ACDC24
		Current (See note)	E5CN-HC2MD-500 ACDC24
		Linear voltage	E5CN-HV2MD-500 ACDC24

**Note:** To order these specific models in silver add "W" to the part number (e.g. E5CN-HR2M-W-500 AC100-240); models with linear voltage output only available in black

### Advanced, High-Performance 1/16 DIN Size Ramp/Soak Temperature and process Controller

- Set up to 8 program patterns with 32 segments (steps) each
- Preventive maintenance for relays in the Temperature Controller using a Control Output On/Off Counter
- Flexible logic operations (AND, OR, and delays) with contact outputs set from CX-Thermo Software
- Achieve high-speed disturbance recovery from 60 ms sampling rate



### Specifications

- Universal Input:
- Thermocouple: Types K, J, T, L, E, U, N, R, S, B, W, or PL II
- Platinum RTD input: Pt100 and JPT100
- Current input: 4-20 mA, 0-20 mA
- Voltage: 1 to 5 V, 0 to 5 V or 0 to 10 V
- Thermocouple: ( $\pm 0.1\%$  of indicated value or  $\pm 1\text{ }^{\circ}\text{C}$ , whichever is greater)  $\pm 1$  digit max.
- Platinum RTD: ( $\pm 0.1\%$  of indicated value or  $\pm 0.5\text{ }^{\circ}\text{C}$ , whichever is greater)  $\pm 1$  digit max.
- Analog Input:  $\pm 0.1\%$  FS  $\pm 1$  digit max.
- CT Input:  $\pm 5\%$  FS  $\pm 1$  digit max.
- Relay Output: SPST-NO. 3 A at 250 VAC
- 100,000 electrical operations (standard)
- Voltage Output: 12 VDC  $\pm 15\%$  for SSR, 21 mA max. load with short-circuit protection
- Current Output: 4-20 mA DC, 0 to 20 mA DC, 600 $\Omega$  max., approx. 10,000 resolution

### Ramp/Soak Temperature and Process Controllers

Supply voltage	Auxiliary outputs	Control outputs	Model (only black models listed)
100-240 VAC, 50/60 Hz	2	Relay	E5CN-HTR2M-500AC100-240
		Current	E5CN-HTC2M-500AC100-240
		Linear voltage	E5CN-HTV2M-500AC100-240
24 VAC, 50/60 Hz, 24 VDC	2	Relay	E5CN-HTR2MD-500AC/DC24
		Voltage	E5CN-HTQ2MD-500AC/DC24
		Current	E5CN-HTC2MD-500AC/DC24
		Linear voltage	E5CN-HTV2MD-500AC/DC24

## Universal Compact Digital Process Controllers

The E5\_N-H series of process controllers take the proven concept of the general purpose E5\_N series to a process level. Main features of the E5\_N-H series are universal inputs, process outputs and options such as transfer output, remote set point and set value programmer.

- Control mode: ON/OFF or 2-PID, Valve control
- Control output: Relay, voltage (pulse), SSR, linear current and voltage
- Power supply: 100-240 VAC or 24 VDC/VAC
- Fast sampling period of 60 ms



- Easy PC connection for parameter cloning, setting and tuning
- Clear and intuitive set-up and operation

## Specifications

- Universal inputs:
  - Thermocouple: Types K, J, T, L, E, U, N, R, S, B, W, or PLII
  - Platinum RTD: Pt100 and JPt100
  - Current input: 4-20 mA, 0 to 20 mA
  - Voltage input: 1 to 5V, 0 to 5V, or 0 to 10V
- Indication Accuracy:
  - Thermocouple:  $\pm 0.1\%$  of indicated value or  $\pm 1^\circ\text{C}$ , whichever is greater  $\pm 1$  digit max.
  - Platinum RTD:  $\pm 0.1\%$  of indicated value or  $\pm 0.5^\circ\text{C}$ , whichever is greater  $\pm 1$  digit max.
  - Analog input:  $\pm 0.1\%$  FS  $\pm 1$  digit max.

## Process Controllers

Control method	Auxiliary output	Control output 1 & 2	Heater burnout	Transfer output	Model 1/4 DIN - E5AN-H models (96 x 96 mm) 1/8 DIN - E5EN-H models (48 x 96 mm)
Basic	2 alarm relays	None fitted, 2 slots*	1-phase	---	E5_N-HAA2HBM-500 AC100240
		2 SSR outputs fitted	1-phase	---	E5_N-HSS2HBM-500 AC100240
		None fitted, 2 slots*	3-phase	4 to 20 mA	E5_N-HAA2HHBFMD-500 AC100240
		2 SS outputs fitted	3-phase	4 to 20 mA	E5_N-HSS2HHBFMD-500 AC100240
	3 alarm relays	None fitted, 2 slots*	---	4 to 20 mA	E5_N-HAA3HHBFMD-500 AC100240
		2 SS outputs fitted	---	4 to 20 mA	E5_N-HSS3HHBFMD-500 AC100240
Valve	2 alarm relays	2 relay outputs fitted	---	---	E5_N-HPRR2BM-500 AC100240
		2 relay outputs fitted	---	4 to 20 mA	E5_NHPRR2BFMD-500 AC100240

\*Select 2 Control Output Units from chart below: Relay, SSR, Voltage pulse (NPN or PNP), Current or Linear voltage  
All E5EN-H/E5AN-H have 2 event inputs and Remote Set point 4 to 20 mA input.

## Output Option Boards

Output option	Model
Relay	E53-RN
Voltage (pulse) 12 VDC PNP	E53-QN
Voltage (pulse) 12 VDC NPN	E53-Q
Voltage (pulse) 24 VDC NPN	E53-Q4

Output option	Model
Linear 4 to 20 mA	E53-C3N
Linear 0 to 20 mA	E53-C3DN
Linear 0 to 10 V	E53-V34N
Linear 0 to 5 V	E53-V35N

# E5AN-HT/E5EN-HT

## Ramp/Soak Temperature and Process Controllers

Quick Link  
M326  
omron247.com

### Advanced, High-Performance 1/4 and 1/8 DIN Size Ramp/Soak Temperature and Process Controllers

- Set up to 8 program patterns with 32 segments (steps) each
- Preventive maintenance for relays in the Temperature Controller using a Control Output ON/Off Counter
- Flexible logic operations (AND, OR, and delays) with contact outputs set from CX-Thermo Software
- Achieve high-speed disturbance recovery from 60 ms sampling rate



### Specifications

- Universal Input:
  - Thermocouple: Types K, J, T, L, E, U, N, R, S, B, W, or PL II
  - Platinum RTD input: Pt100 and JPT100
  - Current input: 4-20 mA, 0-20 mA
  - Voltage: 1 to 5 V, 0 to 5 V or 0 to 10 V
- Indication Accuracy:
  - Thermocouple: ( $\pm 0.1\%$  of indicated value or  $\pm 1\text{ }^{\circ}\text{C}$ , whichever is greater)  $\pm 1$  digit max.
  - Platinum RTD: ( $\pm 0.1\%$  of indicated value or  $\pm 0.5\text{ }^{\circ}\text{C}$ , whichever is greater)  $\pm 1$  digit max.
- Analog Input:  $\pm 0.1\%$  FS  $\pm 1$  digit max.
- CT Input:  $\pm 5\%$  FS  $\pm 1$  digit max.
- Output Types:
  - Relay Output: SPST-NO. 3 A, at 250 VAC 100,000 electrical operations (standard)
  - Voltage Output: 12 VDC  $\pm 15\%$  for SSR, 21 mA max. load with short-circuit protection
  - Current Output: 4-20 mA DC, 0 to 20 mA DC, 600 $\Omega$  max., approx. 10,000 resolution

### Ramp/Soak Temperature and Process Controllers

Control type	Auxiliary outputs	Control output 1/2	Heater burnout	Output Functions			Model
				Event inputs	Transfer output	RSP	
Basic	3	Control Output Unit x 2	---	2	4 to 20 mA output	4 to 20 mA output	1/4 DIN - E5AN-HT (96 x 96 mm) 1/8 DIN - E5EN-HT (48 x 96 mm)
	2		1	---	E5_N-HTAA3BFM-500AC100-240		
	2		2	4 to 20 mA output		E5_N-HTAA2HBM-500AC100-240 E5_N-HTAA2HHBFM-500AC100-240	
Valve	2	Control Output Unit x 2	---	2	---	4 to 20 mA output	E5_N-HTPRR2BM-500AC100-240
	2		---	2	4 to 20 mA output	E5_N-HTPRR2BFM-500AC100-240	

\*Select 2 Control Output Units from chart below: Relay, SSR, Voltage pulse (NPN or PNP), Current or Linear voltage  
All E5EN-H/E5AN-H have 2 event inputs and Remote Set point 4 to 20 mA input.

### Output Option Boards

Output option	Model
Relay	E53-RN
Voltage (pulse) 12 VDC, PNP	E53-QN
Voltage (pulse) 24 VDC, NPN	E53-Q3
Voltage (pulse) 24 VDC, PNP	E53-Q4

Output option	Model
Linear 4 to 20 mA	E53-C3N
Linear 0 to 20 mA	E53-C3DN
Linear 0 to 10 V	E53-V34N
Linear 0 to 5 V	E53-V35N

## Simple to Set and Operate 1/16 DIN Size Controllers

- Easy setting using internal DIP and rotary switches
- ON/OFF or PID control (with on-demand auto-tuning) selectable
- Clearly visible digital display with character height of 13.5 mm
- Deviation indicator makes monitoring more effective
- Models with two alarms are ideal for temperature alarm applications
- Setting change protection prohibits tampering
- Sampling rate (500 ms) and selectable control period (2 and 20 s) improves response
- 8-mode alarm output and sensor error detection



- Input shift adjusts display to reflect known sensor offsets
- Accuracy  $\pm 0.5\%$  of value
- $^{\circ}\text{C}$  or  $^{\circ}\text{F}$  field selectable
- RoHS compliant
- Water-resistant front panel rated NEMA 4X/IP66
- Compact: Measures 48 H x 48 W x 78 D mm

## Specifications

- Multi-input (thermocouple/platinum resistance thermometer) type: K, J, L, T, U, N, R, Pt100, JPt100
- Relay Output: SPST-NO, 3 A at 250 VAC; 100,000 electrical operations
- Voltage Output: 12 VDC for SSR, 21 mA max. load with short-circuit protection

## Ordering Information

Power supply voltage	Number of alarm points	Control output	TC/Pt multi-input Case color: Black Scale marked in $^{\circ}\text{C}$	TC input Case color: Light gray Scale marked in $^{\circ}\text{C}$	Pt Input Case color: Light gray Scale marked in $^{\circ}\text{C}$	TC/Pt multi-input Case color: Black Scale marked in $^{\circ}\text{F}$
100 to 240 VAC, 50/60 Hz	0	Relay	E5CSV-RT AC100-240	---	---	E5CSV-RT-F AC100-240
		Voltage (for driving SSR)	E5CSV-QT AC100-240			E5CSV-QT-F AC100-240
	1	Relay	E5CSV-R1T AC100-240	E5CSV-R1KJ-W	E5CSV-R1P-W	E5CSV-R1T-F AC100-240
		Voltage (for driving SSR)	E5CSV-Q1T AC100-240	E5CSV-Q1KJ-W	E5CSV-Q1P-W	E5CSV-Q1T-F AC100-240
	2 (See note)	Relay	E5CSV-R2T AC100-240	---	---	E5CSV-R2T-F AC100-240
		Voltage (for driving SSR)	E5CSV-Q2T AC100-240			E5CSV-Q2T-F AC100-240
24 VAC/VDC	0	Relay	E5CSV-RTD AC/DC24			---
		Voltage (for driving SSR)	E5CSV-QTD AC/DC24			
	1	Relay	E5CSV-R1TD AC/DC24			E5CSV-R1T-DF AC/DC24
		Voltage (for driving SSR)	E5CSV-Q1TD AC/DC24			E5CSV-Q1T-DF AC/DC24
	2 (See note)	Relay	E5CSV-R2TD AC/DC24			---
		Voltage (for driving SSR)	E5CSV-Q2TD AC/DC24			

Note: Models with two alarm outputs always use the upper limit alarm mode for the alarm 2 output.

## 1/16 DIN Sized, Analog-Set Temperature Controller

- Fits standard 8-pin round sockets
- ON/OFF control models and proportional control models available
- Front panel offset adjustment on proportional control models
- Dual scale models available
- Contact or voltage output models
- Type J or K thermocouples, platinum RTD and thermistor input models
- Panel mount hardware included
- Sockets, protective cover, and other accessories available separately



## Specifications

- Thermocouple Input: Type K or J models
- Platinum RTD Input: Pt100
- Relay Output: SPDT, 3 A at 250 VAC resistive load
- Voltage (pulse) Output: 5 VDC, 10 mA max. with short-circuit protection circuit
- Voltage Types Available:
  - 100 to 120 VAC 50/60 Hz
  - 200 to 240 VAC 50/60 Hz

## Ordering Information

Input type	Temperature range	Setting accuracy	Voltage	Control type	Control output	Model
Thermocouple (K)	32°F - 1112°F	±2% max. of full scale	100/120 VAC, 50/60 Hz	ON/OFF	Relay	E5C2-R20K-W AC100-240 32-1112
Thermocouple (J)	0°C - 200°C and 32°F - 392°F					E5C2-R20J-W AC100-240 32-392
	0°C - 400°C and 32°F - 752°F					E5C2-R20J-W AC100-240 32-752
	0°C - 200°C and 32°F - 392°F			E5C2-R40J-W AC100-240 32-392		
	0°C - 400°C and 32°F - 752°F			E5C2-R40J-W AC100-240 32-752		
				Proportional		



## Space Saving, Ultra Slim 22.5 mm Temperature Monitoring Relays

Prevent equipment against damage from excessive temperature increases.

- Universal-input support for thermocouple and RTD sensors
- Set Value Protection - prohibits changes to set values of the temperature monitoring relay
- Wide range of functions: alarm mode (upper and lower limit), enable/disable latch, selectable temperature setting: Fahrenheit or degrees Celsius
- Simple rotary and DIP switch settings
- Alarm status identification with LED indicator



## Specifications

- Temperature sensor inputs:
  - K8AK-TH11S - Thermocouple Types K, J, T, E; Platinum RTD Pt100
  - K8AK-TH12S - Thermocouple Types K, J, T, E, B, R, S, PLII
- Relay capacity: 3 A @ 250 VAC or 30 VDC (resistive load)
- DIN track mounting
- Dimensions: 90 H x 22.5 W x 100 D mm

## Ordering Information

Description	Features	Relay Output	Model
Temperature range 0 to 999° C/F	Thermocouple/RTD inputs, 1° C/F setting unit	SPDT 3 A @ 250 VAC (resistive load)	K8AK-TH11S 100-240VAC
			K8AK-TH11S 24VAC/DC
Temperature Range 0 to 1800° C, 0 to 3200° F	Thermocouple/RTD inputs, 10° C/F setting unit		K8AK-TH12S 100-240VAC
			K8AK-TH12S 24VAC/DC

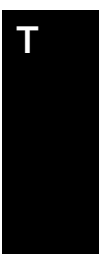

## 1/4 and 1/8 DIN Digital Controllers Offer 5-Digit, 3-Row Display

- A short 50 ms sampling period provides high-speed response
- Single-loop PID control or Single-loop heating and cooling control; multi-loop control models available
- Displays PV, SP, and MV data simultaneously in a 3-row, reverse LCD display with backlight
- Multi-loop (2 or 4 Loop types) control models offer cascade and proportional control all in one unit
- Position-proportional relay output models available for motor/valve control



## Specifications

- Input Types:
  - Thermocouple: Types K, J, T, E, L, U, N, R, S, B, W
  - Platinum RTD inputs: Pt100
  - Current Input: 4 to 20 mA DC, 0 to 20 mA DC (including remote SP input)
  - Voltage Input: 1 to 5 VDC, 0 to 5 VDC, 0 to 10 VDC (including remote SP input (Input impedance: 150  $\Omega$  for current input, approx. 1 M $\Omega$  for voltage input)
- Accuracy:
  - Temperature:  $\pm 0.1\%$  of PV,  $\pm 1$  digit
  - Analog Input:  $\pm 0.1\%$  FS  $\pm 1$  digit max.
- Output Types:
  - Voltage (pulse) Output: 12 VDC, 40 mA max. with short-circuit protection circuit
  - Current output: 0 to 20 mA DC, 4 to 20 mA DC; load: 500  $\Omega$  max. (including transfer output) (Resolution: Approx. 54,000 for 0 to 20 mA DC; Approx. 43,000 for 4 to 20 mA DC)
- Control Method: PID or ON/OFF control

## Ordering Information

Size	Voltage	Control type	Control outputs	Additional features			Model
				Auxiliary outputs	Event inputs	Serial communications	
1/4 DIN	100-240 VAC, 50/60 Hz	1 Loop	2 points: Pulse voltage and Pulse voltage/current	4	2	No	E5AR-Q4B AC100-240
		1 Loop	4 points: Pulse voltage and Pulse voltage/current and Current (2 points)		6	RS-485	E5AR-QC43DB-FLK AC100-240
1/8 DIN	100-240 VAC, 50/60 Hz	1 Loop	2 points: Pulse voltage and Pulse voltage/current	4	2	No	E5ER-Q4B AC100-240
		1 Loop	4 points: Pulse voltage and Pulse voltage/current and Current (2 points)		6	RS-485	E5ER-QC43DB-FLK AC100-240

Note: For 2 or 4 loop controllers visit [www.omron247.com](http://www.omron247.com)

## DIN Track Mounting Modular Temperature Controller

- Two temperature control loops per unit occupy just 30 mm rack space
- Easily expands to 32 control loops with up to 16 E5ZN units
- Plug-in temperature controllers can be replaced without changing terminal wiring
- No power supply and communications wiring required between units when multiple units are mounted side-by-side
- CX-Thermo support software simplifies setup and monitoring via PC
- Optional 1/16 DIN Setting Display Unit for in-panel setting/monitoring
- Field selectable heating or heat/cool control
- One event input per unit



- Serial RS-485 communications built in
- Optional DeviceNet communications unit available
- Dimensions: 134.7 H x 30 W x 112 D mm (socket mounted first unit); 22.5 W for additional units

## Specifications

- Thermocouple Input: Types K, J, T, E, L, U, N, R, S, B
- Platinum RTD Input: Pt100, JPt100
- Voltage Output for SSR: 12 VDC  $\pm 15\%$  (PNP); 21 mA max.; short-circuit protection
- Transistor Output: 100 mA at 30 VDC
- Analog Current Output: 4 to 20/0 to 20 mA DC; 350  $\Omega$  max.
- Transfer Output Accuracy:  $\pm 0.5\%$  FS +0.7 mA or  $\pm 0.5\%$  FS +0.175 V

## Modular Temperature Controllers

Input type	Accuracy	Supply voltage	Control output	Auxiliary output	Additional functions	Model							
Thermocouple	$\pm 0.5\%$ or $\pm 1^\circ\text{C}$ , (whichever is greater) $\pm 1$ digit max.	24 VDC	Voltage for SSR	Transistor output: 2 pts (sinking)	Heater burnout alarm (Use E54-CT1 or E54-CT3 current transformer as detector)	E5ZN-2QNH03TC-FLK							
Platinum RTD						E5ZN-2QNH03P-FLK							
Thermocouple						E5ZN-2QPH03TC-FLK							
Platinum RTD						E5ZN-2QPH03P-FLK							
Thermocouple						E5ZN-2TNH03TC-FLK							
Platinum RTD						E5ZN-2TNH03P-FLK							
Thermocouple			Transistor	Transistor output: 2 pts (sinking)	Transistor output: 2 pts (sinking)	Transfer output (linear voltage output)	E5ZN-2TPH03TC-FLK						
Platinum RTD							E5ZN-2TPH03P-FLK						
Thermocouple							Analog current output	Transistor output: 2 pts (sinking)	Transistor output: 2 pts (sinking)	E5ZN-2CNF03TC-FLK			
Platinum RTD										E5ZN-2CNF03P-FLK			
Thermocouple										Transistor output: 2 pts (sourcing)	Transistor output: 2 pts (sourcing)	Transistor output: 2 pts (sourcing)	E5ZN-2CPF03TC-FLK
Platinum RTD													E5ZN-2CPF03P-FLK

## Terminal Units

Description	Application	Dimensions	Model
Terminal units (include bus system without backplane)	For first E5ZN unit or DeviceNet unit. Equipped with terminals for power supply, communications and setting devices.	134.7 H x 30 W x 46 D mm	E5ZN-SCT24S-500
	For second and additional E5ZN units.	134.7 H x 22.5 W x 46 D mm	E5ZN-SCT18S-500

## Modular In-Panel Temperature/ Process Controller Easily Integrates with Host Devices

- Improves setup through high-speed program-less communications with PLCs, HMIs and Power Controller
- System expandable up to 256 loops for large area control
- Sampling period of 250 ms
- Multi-input units (2 or 4 loops): RTD, thermocouple, current and voltage inputs
- RS-232C/RS-4485 with Modbus RTU and CompoWay/F communications, and dedicated port for G3ZA power controller
- One operation loads all parameters for up to 16 controllers connected to DeviceNet unit



## Specifications



- Universal Inputs:
  - Thermocouple: Types K, J, T, E, L, U, N, R, S, B, W, or PL II
  - Platinum RTD: Pt100 or JPt100
  - Infrared temperature sensor: 10°-260°C
  - Current: 4 to 20 mA or 0 to 20 mA
  - Voltage: 1 to 5 V, 0 to 5 V, or 0 to 10 V
- Accuracy:
  - Temperature Input: ( $\pm 0.5\%$  of indicated value or  $\pm 1^\circ\text{C}$ )  $\pm 1$  digit max.
  - Analog Input:  $\pm 0.5\%$  FS  $\pm 1$  digit

## Temperature/Process Controller Basic Units

Power supply	Control loops	Control outputs 1 and 2	Control outputs 3 and 4	Functions	Communication functions	Terminal	Model
24 VDC from the End Unit	2	2 voltage outputs for SSR	2 transistor outputs (NPN)	2 heater burnout alarms; 2 event inputs	G3ZA Power Controller port: RS-485	M3 terminal	EJ1N-TC2A-QNHB
						Cage clamp	EJ1N-TC2B-QNHB
	4		2 voltage outputs for SSR	None	From End Unit: Port A or B: RS-485	M3 terminal	EJ1N-TC4A-QQ
							Cage clamp
	2	2 current outputs	2 transistor outputs (NPN)	2 event inputs		M3 terminal	EJ1N-TC2A-CNB
							Cage clamp

## Communications Units

Name	Power supply	Auxiliary output	Event inputs	Communication functions	Terminal	Model
High function unit (HFU) (See Note)	24 VDC supplied from End Unit	Transistor output: 4 points (sinking)	4	Port C: RS-485 or RS-232C selectable End Unit Port A: RS-485	M3 terminal	EJ1N-HFUA-NFLK
					4 points (sinking)	EJ1N-HFUB-NFLK
		None	None	Port C: RS-422 End Unit Port A: RS-485	M3 terminal	EJ1N-HFUA-NFL2
					Cage clamp	EJ1N-HFUB-NFL2
		DeviceNet	Cage clamp	EJ1N-HFUB-DRT		
End unit	24 VDC	Transistor output: 2 points (sinking)	None	Port A or B: RS-485 Connector: Port A	M3 terminal	EJ1C-EDUA-NFLK
						Detachable connector

**Note:** The End Unit is always required for connection to a Basic Controller Unit or HFU. An HFU cannot operate without a Basic Unit. External communications cannot be performed using a Basic Unit alone.

## Optimize Cycle Control for SSRs for High-Precision Heat Regulation

- Control up to 8 SSRs with one unit; lower peak current when using offset control
- Low noise, harmonics-free control reduces heater stress
- Accurate power control (within half cycle) with zero-switching control
- Dedicated communications port built into EJ1 Temperature Controllers acts as a “Smart Interface” with the G3ZA
- RS-485 communications to set manipulated variables and heater burnout detection
- Soft-start function for lamp heaters (G3ZA must be used in combination with an SSR without the zero cross function)



- Three-phase optimum cycle control provided for three-phase heaters
- Combine with a special current transformer for 150-A current detection
- Compact size (84 H x 45 W x 111 D mm) is smaller than a standard power controller

## Ordering Information

Name	Number of control channels	Heater burnout detection	Load power supply voltage	Model
Multi-channel power controller	4	Supported	100 to 240 VAC	G3ZA-4H203-FLK-UTU
			400 to 480 VAC	G3ZA-4H403-FLK-UTU
	8	Not supported	100 to 240 VAC	G3ZA-8A203-FLK-UTU
			400 to 480 VAC	G3ZA-8A403-FLK-UTU

## Specifications - Ratings

Item	Load power supply voltage range	100 to 240 VAC	400 to 480 VAC
Power supply voltage		100 to 240 VAC (50/60 Hz)	
Operating voltage range		85 to 264 VAC	
Power consumption		16 VA max.	
Load power supply voltage		100 to 240 VAC	400 to 480 VAC
Load power supply voltage range		75 to 264 VAC	340 to 528 VAC
Manipulated variable input		0.0% to 100.0% (via RS-485 communications)	
Current transformer input		Single-phase AC, 0 to 50 A (primary current of CT) Single-phase AC, 0 to 150 A (primary current of CT)	
Trigger output		One voltage output for each channel, 12 VDC ±15%, Max. load current: 21 mA (with built-in short-circuit protection circuit)	
Alarm output		NPN open collector, one output Max. applicable voltage: 30 VDC, Max. load current: 50 mA Residual voltage: 1.5 V max., Leakage current: 0.4 mA max.	
Indications		LED indicators	
Control method		Optimum cycle control Soft-start optimum cycle control (Use SSR without zero cross function) Three-phase optimum cycle control	

# Temperature Controllers

---

## Contents

Selection Guide	U-ii
<b>Single-Phase</b>	
S8VK-G DIN Rail Mount	U-2
S8VK-R Redundancy PS Module	U-3
S8VS DIN Rail Mount with Smart Display	U-4
S8VM DC Source with Unique Undervoltage Alarm	U-5
S8JX-G Cost-Effective with Multiple Mounting Options	U-6
S8JX-P Power Factor Correction	U-7
<b>Three-Phase</b>	
S8VK-T 3-Phase Switch Mode	U-8

## RELIABLE DC POWER FOR YOUR PANEL

### Keep critical equipment operational with Omron Smart Display Power Supplies

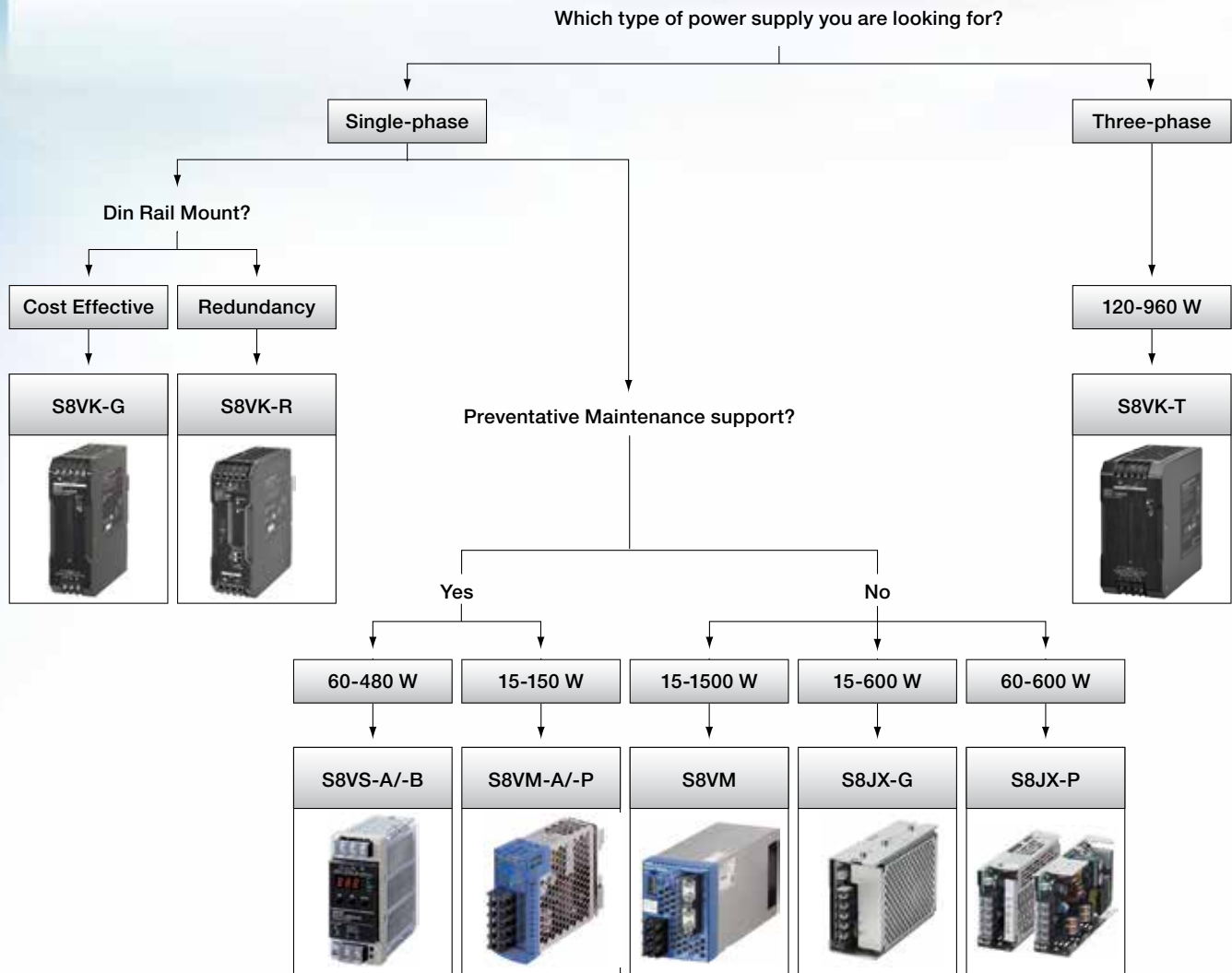

Omron is a world leader in the development and manufacturing of industrial switching power supplies. More than 25 years ago we launched our first compact line, the S82K, and since 2002, our S8VS compact series has been an automatic choice with customers. We expand on this legacy with the introduction of the S8VK series. To provide the perfect solution to match every customer's need, we have launched 3 different families within the S8VK series:

- The standard S8VK-G models
- The redundancy units S8VK-R models
- The three-phase S8VK-T models





# Selection Table



Category		Compact Power Supplies						
								
Selection Criteria	Model	S8VK-G				S8VK-R	S8VS	
	Phases	Single-phase				DC Input Voltage	Single-phase	
	Rated voltage	100 to 240 VAC				5 to 30 VDC	100 to 240 VAC	
	Voltage	5 V	12 V	24 V	48 V	—	24 V	
Power	15 W	■	■	■	—	—	—	
	25 W	—	—	—	—	—	—	
	30 W	■	■	■	—	—	—	
	35 W	—	—	—	—	—	—	
	50 W	—	—	—	—	—	—	
	60 W	—	■	■	—	—	1.3 A	
	90 W	—	—	—	—	—	7.5 A	
	100 W	—	—	—	—	—	—	
	120 W	—	—	■	—	—	5 A	
	150 W	—	—	—	—	—	—	
	180 W	—	—	—	—	—	7.5 A	
	240 W	—	—	■	■	—	10 A	
	300 W	—	—	—	—	—	—	
480 W	—	—	■	■	—	20 A		
Functions	SEMI F47-0200 (200 VAC input)	F47-0706 (200 to 240 VAC)				—	—	■
	Capacitor back-up	—	—	—	—	—	—	□
	Undervoltage alarm	■	■	■	■	—	—	■
	Overvoltage protection	■	■	■	■	—	—	■
	Overload protection	■	■	■	■	—	—	■
	DIN-rail mounting	■	■	■	■	—	—	■
	Screw mounting (with bracket)	■	■	■	■	—	—	—
	EMI Class B	■	■	■	■	—	—	—
	UL Class 2	■	■	■	■	—	—	■ 60 W only
	Parallel operation	■	■	■	■	—	—	—
	Series operation	■	■	■	■	—	—	■
	Service life display/output	—	—	—	—	—	—	□ 60-480 W
Load run-time display/output	—	—	—	—	—	—	□ 60-480 W	

■ Standard    □ Available    — No/not available

# Selection Table

Category		Slim Power Supplies			Slim Power Supplies			
								
Selection Criteria	Model	S8VM			S8JX-G			
	Phases	Single-phase			Single-phase			
	Rated voltage	100 to 240 VAC			100 to 240 VAC			
Power	Voltage	5 V	12 V	24 V	5 V	12 V	15 V	24 V
	15 W	3.0 A	1.3 A	0.65 A	3 A	1.3 A	1 A	0.65 A
	25 W	–	–	–	–	–	–	–
	30 W	6.0 A	2.5 A	1.3 A	–	–	–	–
	35 W	–	–	–	7 A	3 A	2.4 A	1.5 A
	50 W	–	4.3 A	2.2 A	10 A	4.2 A	–	2.1 A
	60 W	–	–	–	–	–	–	–
	90 W	–	–	–	–	–	–	–
	100 W	20.0 A	8.5 A	4.5 A	20 A	8.5 A	–	4.5 A
	120 W	–	–	–	–	–	–	–
	150 W	27.0 A	12.5 A	6.5 A	30 A	13 A	–	6.5 A
	180 W	–	–	–	–	–	–	–
	240 W	–	–	–	–	–	–	–
	300 W	–	27 A	14 A	–	–	–	14 A
	480 W	–	–	–	–	–	–	–
	600 W	–	53 A	27 A	–	–	–	27 A
	960 W	–	–	–	–	–	–	–
	1500 W	–	–	70 A	–	–	–	–
	Functions	SEMI F47-0200 (200 VAC input)	■	■	■	■	■	■
Undervoltage alarm		–	–	■	–	–	–	–
Overvoltage protection		–	■	■	■	■	■	■
Overload protection		–	■	■	■	■	■	■
DIN-rail mounting		–	■	■	■	■	■	■
Screw mounting (with bracket)		–	■	■	■	■	■	■
EMI Class B		–	■	■	–	–	–	–
UL Class 2		–	–	–	–	–	–	–
Parallel operation		–	–	–	–	–	–	–
Series operation	–	■	■	■	■	■	■	

■ Standard    □ Available    – No/not available

Category		Power Factory Correction Power Supplies				Slim Power Supplies
						
Selection Criteria	Model	S8JX-P				S8VK-T
	Phases	Single-phase				Three-phase
	Rated voltage	-				340 to 576 VAC
	Voltage	5 V	12 V	24 V	48 V	24 V
Power	50 W	■	■	■	■	-
	60 W	-	-	-	-	-
	90 W	-	-	-	-	-
	100 W	■	■	■	■	-
	120 W	-	-	-	-	5 A
	150 W	■	■	■	■	-
	180 W	-	-	-	-	-
	240 W	-	-	-	-	10 A
	300 W	■	■	■	■	-
	480 W	-	-	-	-	20 A
600 W	■	■	■	■	-	
960 W	-	-	-	-	40 A	
Functions	SEMI F47-0200 (200 VAC input)	F47-0706 (200 to 240 VAC)				-
	Undervoltage alarm	■	■	■	■	-
	Overvoltage protection	■	■	■	■	■
	Overload protection	■	■	■	■	■
	DIN-rail mounting	■	■	■	■	■
	Screw mounting (with bracket)	■	■	■	■	□
	EMI Class B	-	-	-	-	■
	UL Class 2	-	-	-	-	-
	Parallel operation	-	-	-	-	■
Series operation	■	■	■	■	■	

■ Standard    □ Available    - No/not available

## Reliable and Easy Operation – Worldwide

- Wide operating temperature range: -40°C to 70°C
- 15 W, 30 W, 60 W sizes conform to UL Class 2 Output
- Universal input for worldwide applications: 100 to 240 VAC
- Power boost function at 120%
- Can withstand up to 5G of shock & vibration
- 5-year warranty



## Specifications

- Supply voltage: 100 to 240 VAC
- Output voltage: 5 VDC, 12 VDC, 24 VDC, 48 VDC
- Overload protection
- Overvoltage protection

## Ordering Information

Power rating	Input voltage	Output voltage	Output current	Boost Current	Model
15 W	Single Phase 100 to 240 VAC 90 to 350 VDC	5 V	3 A	3.6 A	S8VK-G01505
		12 V	1.2 A	1.44 A	S8VK-G01512
		24 V	0.65 A	0.78 A	S8VK-G01524
30 W		5 V	5 A	6 A	S8VK-G03005
		12 V	2.5 A	3 A	S8VK-G03012
		24 V	1.3 A	1.56 A	S8VK-G03024
60 W		12 V	4.5 A	5.4 A	S8VK-G06012
		24 V	2.5 A	3 A	S8VK-G06024
120 W		24 V	5 A	6 A	S8VK-G12024
240 W		24 V	10 A	12 A	S8VK-G24024
		48 V	5 A	6 A	S8VK-G24048
480 W		24 V	20 A	24 A	S8VK-G48024
	48 V	10 A	12 A	S8VK-G48048	

# S8VK-R

## Redundancy Unit for Power Supplies

Quick Link

P237

omron247.com

### Compact Din Rail Mount Redundancy Units

- Wide input voltage: 5–30 VDC
- Status confirmation with operating LED
- Output signal for detection of failed power supply
- Wide operating temperature: -40°C to 70°C
- 5-year warranty



### Specifications

- Supply voltage: 5 to 30 VDC



### Ordering Information

Input voltage	Output voltage	Output current	Model
5 to 30 VDC	5 to 30 VDC	10 A	S8VK-R10
10 to 60 VDC	10 to 60 VDC	20 A	S8VK-R20

U

## DIN Rail Mount Power Supplies with Smart Display

Models with Smart Display for diagnostics and output monitoring show output voltage, output current, and peak hold current.



- Ultra-compact size with wide power range of 60-480 W saves panel space
- Unique LED displays and alarm output (60-480 W models) shorten troubleshooting and support preventive maintenance
  - Power supply service life monitor (“A” type)
  - Run-time for connected load monitor (“B” type)
- RoHS compliant
- Power Factor Correction function standard
- Meets international safety standards: UL, cUL, UL508 Listed, SEMI F47 and CE
- 5-year warranty
- Alarm outputs (90 - 480 W LED models) available: 1 undervoltage outputs, 1 for lifetime or run-time

## Ordering Information

Input voltage	Power rating	Output voltage	Output current	Dimensions H x W x D mm	Model
100 to 240 VAC, 50/60 Hz	60 W	24 VDC	2.5 A	95 x 40 x 108.3	S8VS-06024A
					S8VS-06024B
	90 W		3.75 A	115 x 50 x 121.3	S8VS-09024AS
					S8VS-09024A
					S8VS-09024B
	120 W		5 A	115 x 75 x 125.3	S8VS-12024A
					S8VS-12024B
	180 W		7.5 A	115 x 100 x 125.3	S8VS-18024A
					S8VS-18024B
	240 W		10 A	115 x 150 x 127.2	S8VS-24024A
					S8VS-24024B
	480 W		20 A		S8VS-48024A
					S8VS-48024B

## Reliable DC Source with Unique Undervoltage Alarm

- Slim DIN-rail mounting units help downsize machine panels
- Overvoltage protection (standard) of 105% to 160% rated load current
- Undervoltage alarm option signals an error and helps identify the source
- Terminal block protects fingers against electric shock
- Enclosed and open frame models available
- RoHS compliant
- Power Factor Correction function standard
- 5-year warranty



## Ordering Information

Input voltage	Power rating	Output voltage	Output current	Undervoltage alarm	Efficiency	Dimensions H x W x D mm	Model
100 to 240 VAC, 50/60 Hz	15 W	24 VDC	0.65 A	Yes	80% min.	84.5 x 33.5 x 84.5	S8VM-01524AD
	30 W		1.3 A	Yes	81% min.	84.5 x 33.5 x 99.5	S8VM-03024AD
	50 W		2.2 A	Yes	80% min.	84.5 x 33.5 x 124.5	S8VM-05024AD
	100 W		4.5 A	Yes	82% min.	84.5 x 35 x 164.5	S8VM-10024AD
	150 W		6.5 A	Yes	83% min.	84.5 x 44 x 164.5	S8VM-15024AD
	15 W	5 VDC	3.0 A	N/A	75% min.	84.5 x 33.5 x 84.5	S8VM-01505CD
		12 VDC	1.3 A	N/A	78% min.		S8VM-01512CD
		24 VDC	0.65 A	N/A	80% min.		S8VM-01524CD
	30 W	5 VDC	6.0 A	N/A	75% min.	84.5 x 33.5 x 99.5	S8VM-03005CD
		12 VDC	2.5 A	N/A	79% min.		S8VM-03012CD
		24 VDC	1.3 A	N/A	81% min.		S8VM-03024CD
	50 W	5 VDC	10.0 A	N/A	80% min.	84.5 x 33.5 x 124.5	S8VM-05005CD
		12 VDC	4.3 A	N/A	79% min.		S8VM-05012CD
		24 VDC	2.2 A	N/A	80% min.		S8VM-05024CD
	100 W	5 VDC	20.0 A	N/A	81% min.	84.5 x 35 x 164.5	S8VM-10005CD
		12 VDC	8.5 A	N/A	81% min.		S8VM-10012CD
		24 VDC	4.5 A	N/A	82% min.		S8VM-10024CD
	150 W	5 VDC	27.0 A	N/A	81% min.	84.5 x 44 x 164.5	S8VM-15005CD
		12 VDC	12.5 A	N/A	81% min.		S8VM-15012CD
		24 VDC	6.5 A	N/A	83% min.		S8VM-15024CD
300 W		14 A; Peak current: 16.5 A (200 VAC)	N/A	81% min.	83.5 x 62.5 x 188	S8VM-30024C	
600 W		27 A; Peak current: 31 A (200 VAC)	N/A	81% min.	83.8 x 101.8 x 192	S8VM-60024C	
1500 W		65 A (100 VAC), 70 A (200 VAC); Peak current: 105 A (200 VAC)	N/A	82% min.	82 x 126.5 x 327	S8VM-15224C	

Note: Optional mounting brackets available.

## Cost-Effective Power Supplies with Multiple Mounting Options

- Wide power range of 15 - 600 W and voltages (5, 12, 15, 24, 48 VDC)
- Universal input voltage
- Multiple mounting options
- Series operation: connect up to 2
- Parallel operation on 300 and 600 W
- Built-in overload and overvoltage protection
- Approvals: UL, cUL, UL508 Listed, CE, SEMI F47, VDE
- Adjustable voltage output (-10% to 15%)



- 5-year warranty
- 48 V output available

## Ordering Information

Power rating	Output voltage	Output current	Dimensions H x W x D mm	Part numbers			
				Open frame		Covered frame	
				Front* mount	DIN-rail mount	Front* mount	DIN-rail mount
15 W	5 V	3 A	96 x 39.5 x 114.5	S8JX-G01505	S8JX-G01505D	S8JX-G01505C	S8JX-G01505CD
	12 V	1.3 A		S8JX-G01512	S8JX-G01512D	S8JX-G01512C	S8JX-G01512CD
	15 V	1 A		S8JX-G01515	S8JX-G01515D	S8JX-G01515C	S8JX-G01515CD
	25 V	0.65 A		S8JX-G01524	S8JX-G01524D	S8JX-G01524C	S8JX-G01524CD
35 W	5 V	7 A	96 x 39.5 x 114.5	S8JX-G03505	S8JX-G03505D	S8JX-G03505C	S8JX-G03505CD
	12 V	3 A		S8JX-G03512	S8JX-G03512D	S8JX-G03512C	S8JX-G03512CD
	15 V	2.4 A		S8JX-G03515	S8JX-G03515D	S8JX-G03515C	S8JX-G03515CD
	24 V	1.5 A		S8JX-G03524	S8JX-G03524D	S8JX-G03524C	S8JX-G03524CD
50 W	5 V	10 A	97 x 40 x 124.5	S8JX-G05005	S8JX-G05005D	S8JX-G05005C	S8JX-G05005CD
	12 V	4.2 A		S8JX-G05012	S8JX-G05012D	S8JX-G05012C	S8JX-G05012CD
	24 V	2.1 A		S8JX-G05024	S8JX-G05024D	S8JX-G05024C	S8JX-G05024CD
100 W	5 V	10 A	97 x 50 x 174.5	S8JX-G10005	S8JX-G10005D	S8JX-G10005C	S8JX-G10005CD
	12 V	8.5 A		S8JX-G10012	S8JX-G10012D	S8JX-G10012C	S8JX-G10012CD
	24 V	4.5 A		S8JX-G10024	S8JX-G10024D	S8JX-G10024C	S8JX-G10024CD
150 W	24 V	6.5 A	97 x 50 x 174.5	S8JX-G15024	S8JX-G15024D	S8JX-G15024C	S8JX-G15024CD
300 W	24 V	14 A	96 x 110 x 204.8	-	-	S8JX-G30024C	S8JX-G30024CD
600 W	24 V	27 A	92 x 150 x 184.2	-	-	S8JX-G60024C	-

\* Front mount models can also be side- or bottom-mounted. Front mounting bracket included. See datasheet for other optional mounting bracket details.

## Optional Mounting Brackets

Description	Part number
Mounting Bracket A (bottom mounting for 50 W models)	S82Y-JX05B
Mounting Bracket B (bottom mounting for 100 W: 24 V models)	S82Y-JX10B
Mounting Bracket C (bottom mounting for 100 W: 5 V and 12 V models and 150 W models)	S82Y-JX15B
Mounting Bracket D (front mounting for 100 W: 5 V and 12 V models and 150 W models)	S82Y-JX15F



## Dependable Power Supplies with EMI Class B and Power Factor Correction

- Wide selection of power ranges (50 to 600 W) of and voltages (5, 12, 24, 48)
- Conforms to EMI EN55011 Class B
- Universal input voltage
- Series operation: connect up to 2 units
- Parallel operation on 300 and 600 W
- Approvals: UL, CUL, UL508 Listed, CE, SEMI 476, VDE
- Adjustable voltage output (-10% to 15%)
- 5-year warranty



## Ordering Information

Power rating	Output Voltage	Output Current	Dimensions H x W x D	Model			
				Open Frame		Closed Frame	
				Front Mount	DIN-rail Mount	Front Mount	DIN-rail Mount
50 W	5 V	10 A	92 x 42 x 118	S8JX-P05005	S8JX-P05005D	S8JX-P05005C	S8JX-P05005CD
	12 V	4.2 A		S8JXT-P05012	S8JX-P05012D	S8JX-P05012C	S8JX-P05012CD
	24 V	2.1 A		S8JX-P05024	S8JX-P05024D	S8JX-P05024C	S8JX-P05024CD
	48 V	1.1 A		S8JX-P05048	S8JX-P05048D	S8JX-P05048C	S8JX-P05048CD
100 W	5 V	20 A	92 x 42 x 148	S8JX-P10005	S8JX-P10005D	S8JX-P10005C	S8JX-P10005CD
	12 V	8.5 A		S8JX-P10012	S8JX-P10012D	S8JX-P10012C	S8JX-P10012CD
	24 V	4.5 A		S8JX-P10024	S8JX-P10024D	S8JX-P10024C	S8JX-P10024CD
	48 V	2.1 A		S8JX-P10048	S8JX-P10048D	S8JX-P10048C	S8JX-P10048CD
150 W	5 V	30 A	92 x 42 x 148	S8JX-P15005	S8JX-P15005D	S8JX-P15005C	S8JX-P15005CD
	12 V	13 A		S8JX-P15012	S8JX-P15012D	S8JX-P15012C	S8JX-P15012CD
	24 V	6.5 A		S8JX-P15024	S8JX-P15024D	S8JX-P15024C	S8JX-P15024CD
	48 V	3.3 A		S8JX-P15048	S8JX-P15048D	S8JX-P15048C	S8JX-P15048CD
300 W	24 V	14 A peak current 16.5 A (200 VAC)	110 x 77.6 x 239.8	—	—	S8JX-P300224	S8JX-P300224CD
600 W	24 V	27 A peak current 31 A (200 VAC)	92 x 110 x 239.8	—	—	S8JX-P60024C	S8JX-P60024CD

## 3-Phase Switch Mode Power Supply

- Wide operation range: -40 to 70°C
- Power boost function at 120%
- Double pole on output terminal with one extra negative terminal
- Wide input range:  
 3 x 380 to 480 VAC (3 x 320 to 576 VAC)
- Possible for 2 phases input usage with derating:  
 2 x 380 to 480 VAC (2 x 340 to 576 VAC)
- DC input availability:  
 450 to 600 VDC (450 to 810 VAC)
- Protection: NEMA 1/IP20



## Ordering Information

Input voltage	Power rating	Output voltage	Output current	Boost Current	Model
3x 380 to 480 VAC 2x 380 to 480 VAC 450 to 600 VDC	120 W	24 V	5 A	6 A	S8VK-T12024
	240 W		10 A	12 A	S8VK-T24024
	480 W		20 A	24 A	S8VK-T48024
	960 W		40 A	48 A	S8VK-T96024



## Contents

Selection Guide		V-ii
<b>Digital Timers</b>		
H5CX-N	Digital multi-function timers, 1/16 DIN	V-1
H3CA	Digital-set timer with LCD bar graph display, 1/16 DIN	V-2
<b>Analog Timers</b>		
H3CR	Analog-set multi-function timers, 1/16 DIN	V-3
H3YN	Compact, socket mount, analog-set relay timers with multiple operating modes	V-4
H3JA	Economical, compact, plug-in timer, 36 x 36 mm	V-4
H3DK	Slim 22.5 mm track-mount analog-set timers	V-5
H3DS	Slim 17.5 mm track-mount analog-set timers	V-6
<b>Time Switches</b>		
H5S	Weekly and yearly timers with AM/PM display	V-7
H5L	Digital weekly time switch with large display	V-8
H5F	Digital daily time control with simple operations	V-8
<b>Digital Counters</b>		
H7CX-N	Advanced 1/16 DIN size preset counters	V-9
H7EC/ H7ET/ H7ER	Subminiature totalizer, time counter, LCD tachometer	V-10
H7BX	72 x 72 mm multi-function counter with a bright, easy-to-view, negative transmissive LCD	V-11
H7CN	1/16 DIN, single preset counter with four-digit LED Display	V-11
H7GP	Total count/total time 48x24 mm	V-12
H7HP	Total count/total time 72x36 mm	V-13

## WHEN TIMING ACCURACY MATTERS!

### H5CX-N – The most complete digital timer



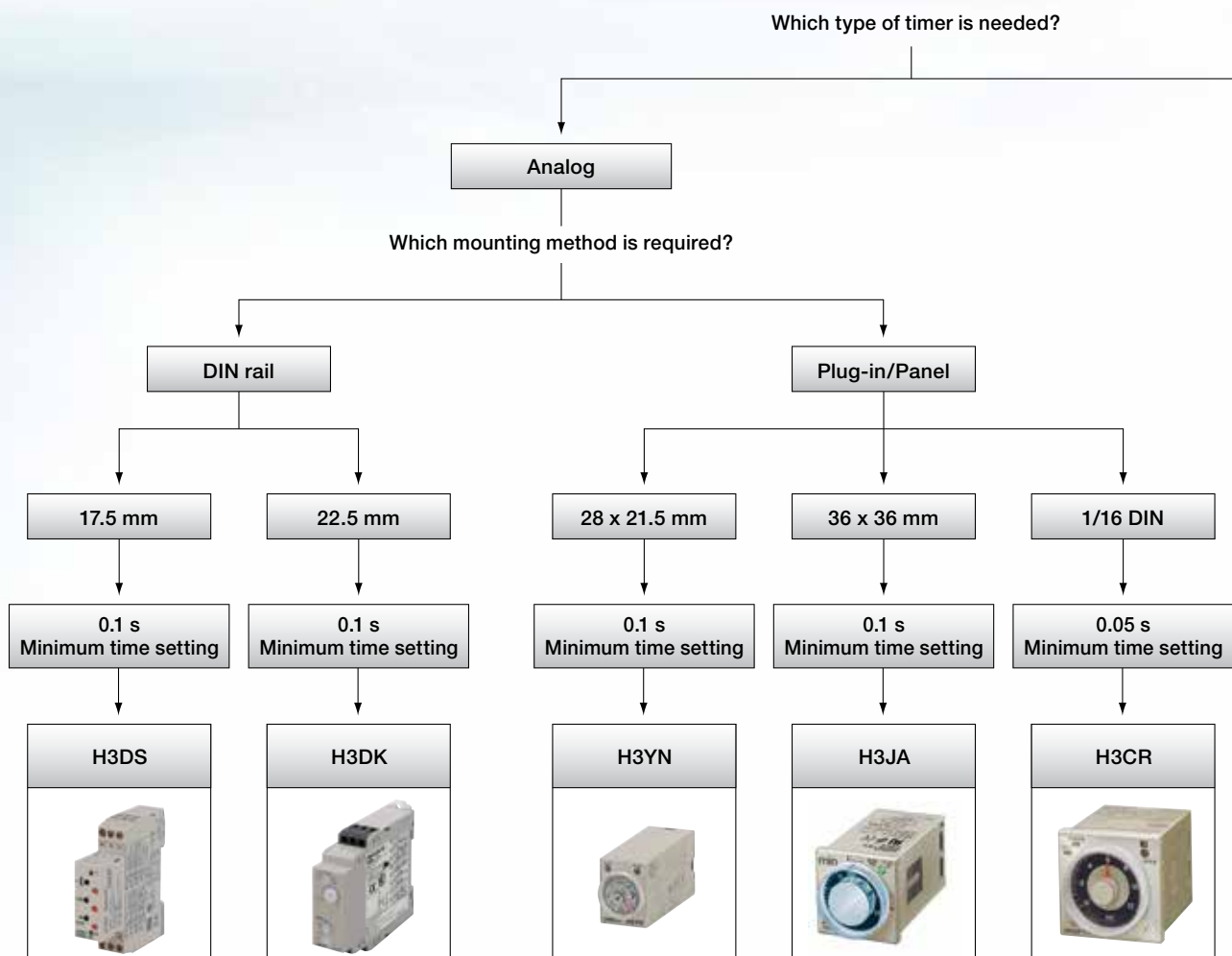

The H5CX-N series offers multiple functions and timing ranges for precise timing control, as well as real twin-timing and memory function. These and other added-value features ensure that the H5CX-N covers almost every possible user requirement in timers.

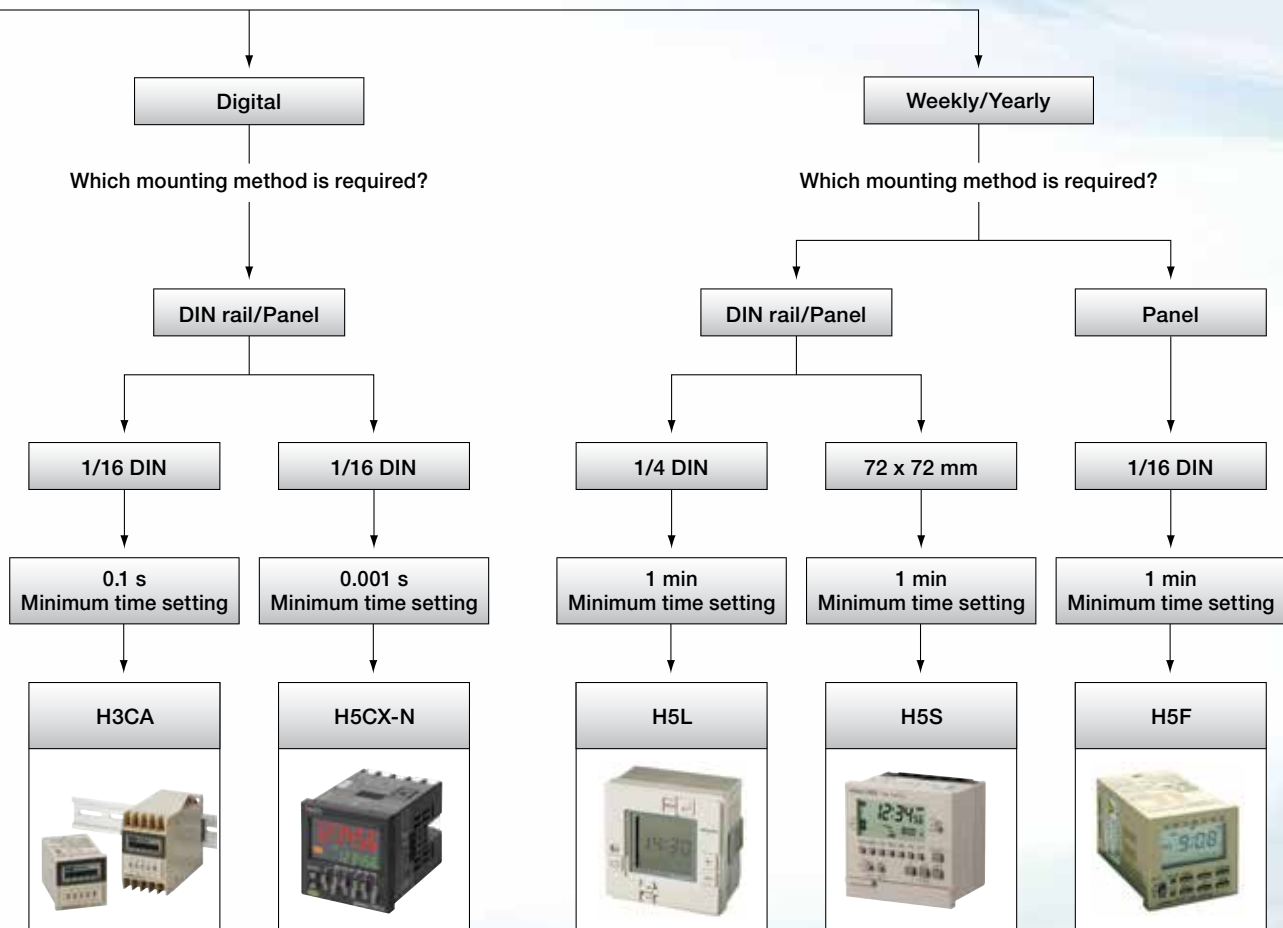
- 15 different time functions
- Three color display value: red, orange or green
- Models with instantaneous contact outputs
- 10 different timing ranges to choose from: 0.001 s to 9999 h







# Selection Table

Category		Analog Solid State Timer				
						
Selection criteria	Model	H3DS-M	H3DS-S	H3DS-A	H3DS-F	
	Mounting	DIN-rail				
	Width	17.5 mm				
	Type	Multi-functional		ON-delay (fixed)	Twin timer	
Contact configuration	Time limit	■	■	■	■	
	Instantaneous	—	—	—	—	
	Programmable contacts	—	—	—	—	
	14 pins	—	—	—	—	
	11 pins	—	—	—	—	
	8 pins	—	—	—	—	
	Screw terminals	■	■	■	■	
	Screw-less clamp terminals	□	□	□	□	
Inputs	Screw-less clamp sockets	—	—	—	—	
	Voltage input	□	□	□	—	
Outputs	Transistor	—	—	—	—	
	Relay	■	■	■	■	
	SCR	—	—	—	—	
	Relay output type	SPDT	■	■	■	■
		SPST-NO	—	—	—	—
		DPDT	—	—	—	—
		4PDT	—	—	—	—
Features	Time range	Total time range	0.1 s to 120 h	1 s to 120 h	2 s to 120 h	0.1 s to 12 h
		Number of sub ranges	7	7	7	6
	Supply voltage	24 to 230 VAC, or 24 to 48 VDC	24 to 230 VAC, or 24 to 48 VDC	24 to 230 VAC, or 24 to 48 VDC	24 to 230 VAC, or 24 to 48 VDC	
	Number of operating modes	8	4	1	2	
Functions	ON-delay	■	■	—	—	
	Flicker OFF start	■	—	—	■	
	Flicker ON start	■	■	—	■	
	Signal ON-/OFF-delay	■	—	—	—	
	Signal OFF-delay	■	—	—	—	
	Interval (signal or power start)	■	■	—	—	
	One-shot output (ON-delay)	■	■	—	—	
	ON-delay (fixed)	—	—	■	—	
	Independent ON/OFF time setting	—	—	—	—	
	Star-delta	—	—	—	—	
Re-remarks	Transistor	—	—	—	—	





■ Standard    □ Available    — No/not available



Category		Analog Solid State Timer				
						
Selection criteria	Model	H3DK-M	H3DK-S	H3DK-F	H3DK-H	
	Mounting	DIN-rail				
	Width	22.5 mm				
	Type	Multi-functional		Twin timer	Power OFF-delay	
Contact configuration	Time limit	■	■	■	■	
	Instantaneous	■	■	—	■	
	Programmable contacts	■	■	—	—	
	14 pins	—	—	—	—	
	11 pins	—	—	—	—	
	8 pins	—	—	—	—	
	Screw terminals	■	■	■	■	
	Screw-less clamp terminals	—	—	—	—	
Inputs	Screw-less clamp sockets	—	—	—	—	
	Voltage input	■	—	—	—	
Outputs	Transistor	—	—	—	—	
	Relay	■	■	■	■	
	SCR	—	—	—	—	
	Relay output type	SPDT	■	■	■	■
		SPST-NO	—	—	—	—
		DPDT	□	■	—	—
4PDT		—	—	—	—	
Features	Time range	Total time range	0.1 s to 1200 h	0.1 s to 1200 h	0.1 s to 1200 h	0.1 to 12 s 1.0 to 120 s
		Number of sub ranges	8	8	8	2 (model dependent)
	Supply voltage	24 to 240 VAC/DC, or 12 VDC	24 to 240 VAC/DC, or 12 VDC	24 to 240 VAC/DC, or 12 VDC	24 to 240 VAC/DC, or 12 VDC	100 to 120 VAC, 200 to 240 VAC, or 24 to 48 VAC/DC
	Number of operating modes	8	4	2	1	
Functions	ON-delay	■	■	—	—	
	Flicker OFF start	■	—	■	—	
	Flicker ON start	■	■	■	—	
	Signal ON-/OFF-delay	■	—	—	—	
	Signal OFF-delay	■	—	—	■	
	Interval (signal or power start)	■	■	—	—	
	One-shot output (ON-delay)	■	■	—	—	
	ON-delay (fixed)	—	—	—	—	
	Independent ON/OFF time setting	—	—	—	—	
	Star-delta	—	—	—	—	
Re-remarks	Transistor	—	—	—	—	

■ Standard    □ Available    — No/not available





# Selection Table

Category		Analog Solid State Timer					
							
Selection criteria	Model	H3CR-A	H3CR-F	H3CR-H	H3YN	H3JA	
	Mounting	Socket/on panel					
	Width	1/16 DIN	1/16 DIN	1/16 DIN	21.5 x 28 mm	36 x 36 mm	
Contact configuration	Type	Multi-functional	Twin timer	Power OFF-delay	Miniature	Miniature	
	Time limit	■	■	■	■	■	
	Instantaneous	■	—	—	—	—	
	Programmable contacts	—	—	—	—	—	
	14 pins	—	—	—	■	—	
	11 pins	□	■	■	—	—	
	8 pins	□	■	■	■	■	
	Screw terminals	—	—	—	—	—	
	Screw-less clamp terminals	—	—	—	—	—	
Screw-less clamp sockets	—	—	—	□	—		
In-puts	Voltage input	□	—	—	—	—	
	Transistor	□	—	—	—	—	
Outputs	Relay	□	■	■	■	■	
	SCR	—	—	—	—	—	
	Relay output type	SPDT	□	—	□	—	■
		SPST-NO	—	—	—	—	—
		DPDT	□	■	□	■	■
		4PDT	—	—	—	■	—
Features	Time range	Total time range	0.05 s to 300 h, 0.1 s to 600 h (model dependent)	0.05 s to 30 h or 1.2 s to 300 h (model dependent)	0.05 s to 12 s, 0.05 to 12 min	0.1 s to 10 h (model dependent)	0.1 s to 3 h
		Number of sub ranges	9	14	4	2	1 range per model, 12 models
	Supply voltage	• 100 to 240 VAC / 100 to 125 VDC • 24 to 48 VAC / 12 to 48 VDC	• 100 to 240 VAC / 100 to 125 VDC • 24 to 48 VAC / 12 to 48 VDC	• 100 to 240 VAC / 100 to 125 VDC • 24 to 48 VAC / 12 to 48 VDC	• 24, 100 to 120, 200 to 230 VAC • 12, 24, 48, 100 to 110, 125 VDC	• 100-120 VAC • 200-240 VAC • 24 VAC • 12 VDC • 24 VDC	
	No. of operating modes	6 (model dependent)	1	1	4	1	
Functions	ON-delay	□	—	—	■	■	
	Flicker OFF start	□	■	—	■	—	
	Flicker ON start	□	□	—	■	—	
	Signal ON-/OFF-delay	□	—	—	—	—	
	Signal OFF-delay	□	—	■	—	—	
	Interval (signal or power start)	□	—	—	■	—	
	One-shot output (ON-delay)	□	—	—	—	—	
	ON-delay (fixed)	—	—	—	—	—	
	Independent ON/OFF time setting	—	—	—	—	—	
Star-delta	—	—	—	—	—		
Re-remarks	Transistor	□	—	—	—	—	

■ Standard    □ Available    — No/not available





Category		Digital Timer		Weekly Timer			
							
Selection criteria	Model	H5CX-N	H3CA	H5S	H5L	H5F	
	Mounting	Socket/on panel		DIN rail/panel			
	Width	1/16 DIN	1/16 DIN; 75 x 45 mm	72 x 72 mm	1/4 DIN	1/16 DIN	
	Type	Multi-functional	Multi-functional with LCD bar graph display	Digital weekly and yearly timer	Digital weekly timer with large display	Digital daily timer	
Contact configuration	Time limit	■	■	—	—	—	
	Instantaneous	■	■	—	—	—	
	Programmable contacts	■	—	■	■	■	
	14 pins	—	—	—	—	—	
	11 pins	■	■	—	—	—	
	8 pins	■	■	—	—	—	
	Screw terminals	□	□ H3CA-FA	■	■	■	
	Screw-less clamp terminals	—	—	—	—	—	
Screw-less clamp sockets	—	—	—	—	—		
In-puts	Voltage input	—	—	—	—	—	
	Transistor	□	—	—	—	—	
Outputs	Relay	□	■	■	■	■	
	SCR	—	—	—	—	—	
	Relay output type	SPDT	□	■	—	—	—
		SPST-NO	—	—	2 @ 15 A weekly or yearly, 4 @ 3 A yearly	2 @ 15 A	1 @ 15 A
		DPDT	—	■	—	—	—
		4PDT	—	—	—	—	—
Features	Time range	Total time range	0.001 s to 9999 h configurable	0.1 s to 9990 h	0.00 to 23.59 h	0.00 to 23.59 h	0.00 to 23.59 h
		Number of sub ranges	10	7	3	1	1
	Supply voltage	• 100 to 240 VAC • 24 VAC • 12 to 24 VDC	• 24 to 240 VAC • 12 to 240 VDC • see datasheet for H3CA-8	• 100 to 240 VAC • 24 VDC	• 100 to 240 VAC	• 100 to 240 VAC	
	No. of operating modes	15	8	—	—	—	
Functions	ON-delay	■	■	—	—	—	
	Flicker OFF start	■	■	—	—	—	
	Flicker ON start	■	■	—	—	—	
	Signal ON-/OFF-delay	■	■	—	—	—	
	Signal OFF-delay	■	■	—	—	—	
	Interval (signal or power start)	■	■	—	—	—	
	One-shot output (ON-delay)	■	■	—	—	—	
	ON-delay (fixed)	■	—	—	—	—	
	Independent ON/OFF time setting	■	—	■	■	■	
	Star-delta	—	—	—	—	—	
Re-marks	Transistor	■	—	—	—	—	

■ Standard    □ Available    — No/not available

## MULTI-FUNCTIONAL PRESET COUNTER

### H7CX-N – Designed with value-added features

The H7CX-N series offers the ultimate in versatility and intuitive programming.

- 7 basic functions in one
- Choose green, orange, or red color for present value
- Twin counter mode
- Character height: 12 mm (4 digit models) and 10 mm (6 digit models)
- Display 6 digits from -99999 up to 999999

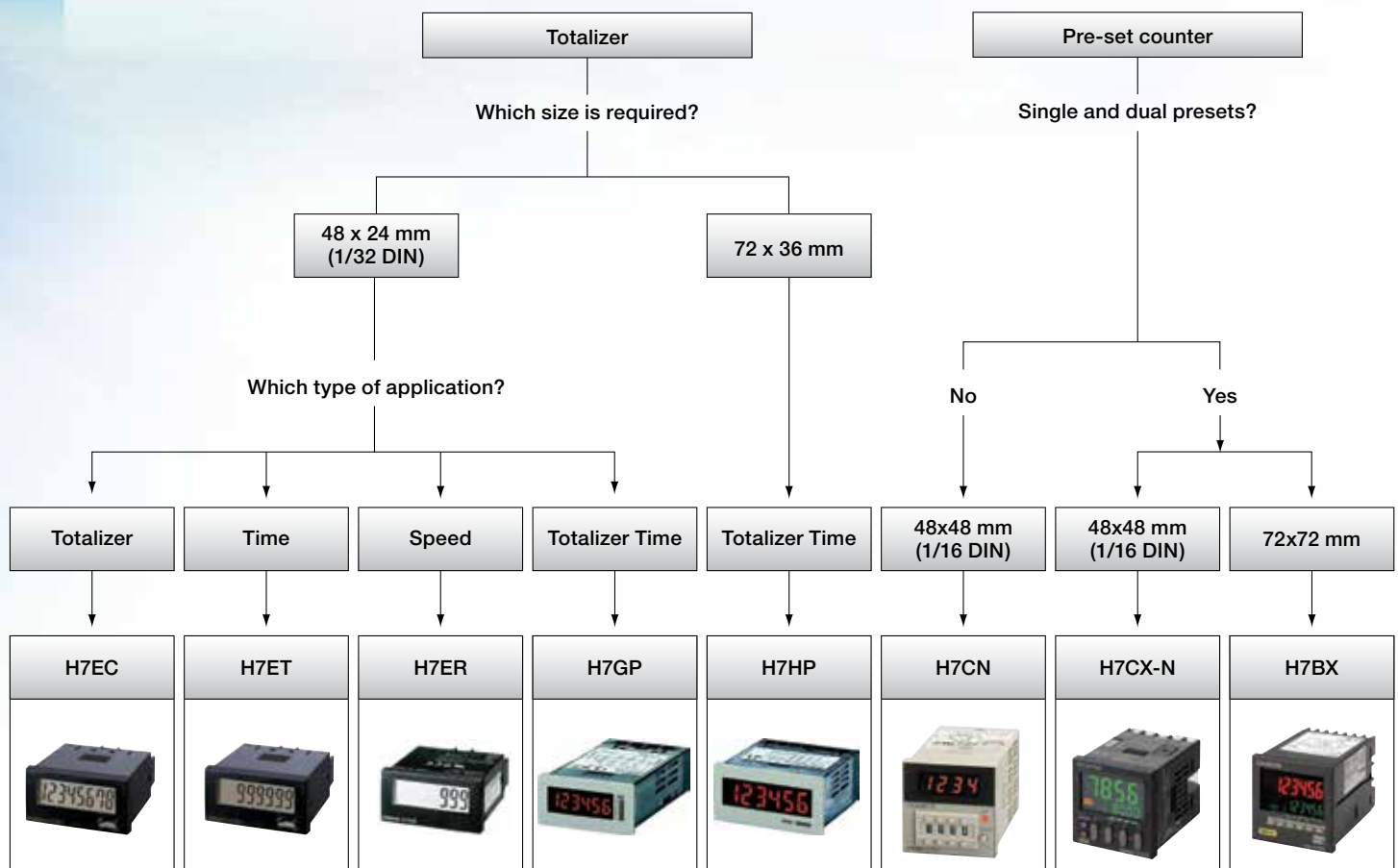

# Selection Table







Category		Self-powered Count Totalizer	Self-powered Time Totalizer	Self-powered Tachometer	Pre-set Counter
Selection criteria	Model	H7EC	H7ET	H7ER	H7CN
	Display	LCD	LCD	LCD	LED
	Size	1/32 DIN	1/32 DIN	1/32 DIN	1/16 DIN
Outputs	Control outputs	—	—	—	Relay (SPST-NO or SPDT) or solid state open-collector
	5 stage	—	—	—	—
	Total	■	—	—	■
	Time	—	■	—	—
	Preset	—	—	—	■
	Batch	—	—	—	—
	Dual	—	—	—	—
	Tachometer	—	—	■	—
Inputs	Control inputs	<ul style="list-style-type: none"> <li>• No-voltage</li> <li>• PNP/NPN</li> <li>• DC-voltage</li> <li>• AC/DC multi-voltage</li> </ul>	<ul style="list-style-type: none"> <li>• No-voltage</li> <li>• PNP/NPN</li> <li>• DC-voltage</li> <li>• AC/DC multi-voltage</li> </ul>	<ul style="list-style-type: none"> <li>• No-voltage</li> <li>• PNP/NPN</li> <li>• DC-voltage</li> </ul>	See datasheet regarding inputs
	Dual operation	—	—	—	—
Features	Number of digits	8	7	4 or 5	PV: 4, SV: 4
	NPN/PNP switch	—	—	—	—
	Back-lit	□	□	□	—
	External reset	■	■	—	■
	Manual reset	■	■	—	■
	Number of banks	—	—	—	—
	Memory backup	—	—	—	EEPROM
	Built-in sensor power supply	—	—	—	—
Terminals	IP rating (front face)	IP66/NEMA 4	IP66/NEMA 4	IP66/NEMA 4	—
	Screw Terminals	■	■	■	—
	8-pin socket	—	—	—	■
Supply voltage	11-pin socket	—	—	—	■
	100 to 240 VAC	—	—	—	■
	24 VAC, 12-24 VDC	—	—	—	—
	24 VDC	□	□	□	—
Functions	12 to 48 VDC	—	—	—	■
	Up	■	■	■	■
	Down	—	—	—	■
	Up/down	—	—	—	—
	Reversible	—	—	—	■
	Speed	20 Hz or switchable 30 Hz / 1 kHz	—	1 or 10 kHz	0.01 to 30 Hz or 0.01 to 5 kHz
	Counting range	0 to 99999999	0.0 h to 999999.9 h <--> 0.0 h to 3999 d 23.9 h or 0 s to 999 h 59 min 59 s <--> 0.0 min to 9999 h 59.9 min	1000 s <sup>-1</sup> or 1000 min <sup>-1</sup> ; 1000 s <sup>-1</sup> or 1000 min <sup>-1</sup> <--> 10000 min <sup>-1</sup>	0 to 9999
Color	Beige	□	□	□	■
	Black	■	■	■	—

■ Standard    □ Available    — No/not available



For complete specifications and additional models and accessories visit [www.omron247.com](http://www.omron247.com)

# Counters

Counter Type		Multi-function	Multi-function	Total Count/ Total Time	Total Count/ Total Time
					
Selection criteria	Model	H7CX-N	H7BX	H7GP	H7HP
	Display	LCD negative transmissive	LCD negative transmissive	LCD negative transmissive	LCD negative transmissive
	Size	1/16 DIN	72 x 72 mm	48 x 24 mm	72 x 36 mm
Outputs	Control outputs	1 relay (SPDT), transistor	Contact and NPN transistor	–	–
	5 stage	■	■	–	–
	Total	■	■	■	■
	Time	–	■	■	■
	Preset	■	■	–	–
	Batch	■	■	–	–
	Dual	■	■	–	–
	Tachometer	■	■	–	–
Inputs	Control inputs	• No-voltage • PNP/NPN	• No-voltage • PNP/NPN	• PNP/NPN	• PNP/NPN
Features	Dual operation	■	■	–	–
	Number of digits	PV: 4, SV: 4 or PV: 6, SV: 6	PV: 6, SV: 6	6 or 8 digits	6 digits
	NPN/PNP switch	■	■	–	–
	Back-lit	■	■	■	■
	External reset	■	■	■	■
	Manual reset	■	8 (16- and 32-output models only)	–	–
	Memory backup	10 year data storage	10 year data storage	20 year data storage	20 year data storage
	Built-in sensor power supply	–	–	–	–
IP rating (front face)	IP66/NEMA 4	IP54	IP66/NEMA 4	IP66/NEMA 4	
Terminals	Screw Terminals	■	■	■	■
	8-pin socket	–	–	–	–
	11-pin socket	■	–	–	–
Supply voltage	100 to 240 VAC	■	■	■	■
	24 VAC, 12-24 VDC	■	■	■	■
	24 VDC	–	–	–	–
	12 to 48 VDC	–	–	–	–
Functions	Up	■	■	■	■
	Down	■	■	–	–
	Up/down	■	■	–	–
	Reversible	■	–	–	–
	Speed	0.01 to 30 Hz or 0.01 to 5 kHz	0.01 to 30 Hz or 0.01 to 5 kHz	–	–
	Counting range	–99999 to 999999	–99999 to 999999	–99999 to 999999	0 to 999999
Color	Beige	–	–	■	■
	Black	■	■	■	■

■ Standard    □ Available    – No/not available

## Space-Saving 1/16 DIN Timer with All-in-one Functionality

Easy-to-set timing and security functions satisfy multiple design needs with a single part, reducing your stock. High accuracy setting and operation in all modes assures reliable performance.

- Short body: Only 59 mm depth for 24 VAC/ VDC models, 78 mm depth for 100-240 VAC models
- Waterproof/dust proof front (UL 508 Type 4X and IP66)
- Isolated inputs and power eliminates unwanted circuit paths
- Built-in output cycle counter supports predictive maintenance
- Green and orange display shows change in output status



Type	Time specifications	Operating modes	Connection type	Inputs	Output type	Supply voltage	Model
H5CX-A series 4-digit models	0.001 to 9.999 s 0.01 to 99.99 s 0.1 to 999.9 s 1 to 9999 s 1 s to 99 min 59 s 0.1 to 999.9 min 1 to 9999 min 1 min to 99 h 59 min 0.1 to 999.9 h 1 to 9999 h	Timer Mode A: Signal ON Delay I A-1: Signal ON Delay II A-2: Power ON Delay I A-3: Power ON Delay II b: Repeat cycle 1 b-1: Repeat cycle 2 d: Signal OFF Delay E: Interval F: Cumulative Z: ON/OFF-duty-adjustable flicker S: Stopwatch	Screw terminals	Signal, Reset, Gate (NPN/PNP input)	Contact output (time-limit SPDT)	100 to 240 VAC	H5CX-A-N
							12 to 24 VDC/ 24 VAC
			11-pin socket		100 to 240 VAC	H5CX-A11-N	
			11-pin socket	Signal, Reset (NPN input)	12 to 24 VDC/ 24 VAC	H5CX-A11D-N	
H5CX-L series 4-digit models		Twin Timer Mode t-off: Flicker OFF Start 1 t-on: Flicker ON Start 1 t-off-1: Flicker OFF Start 2 t-on-1: Flicker ON Start 2	8-pin socket		Contact output (time-limit SPDT + instantaneous SPDT) Models with instantaneous contact outputs	100 to 240 VAC	H5CX-L8-N
						12 to 24 VDC/ 24 VAC	H5CX-L8D-N
				None	100 to 240 VAC	H5CX-L8E-N	
					12 to 24 VDC/ 24 VAC	H5CX-L8ED-N	
H5CX-B series 6-digit model	0.01 to 9999.99 s 1 s to 99 h 59 min 59 s 0.1 to 99999.9 min 0.1 to 99999.9 h	A: Signal ON Delay I F-1: Cumulative	Screw terminals	Signal, Reset, Gate (NPN/PNP input)	Transistor output (DPST)	12 to 24 VDC	H5CX-BWSD-N

## 1/16 DIN, Digital-Set Timer with LCD Bar Graph Display

- 8 field selectable operation modes or ON-delay only model
- Time remaining LCD bar graph and LCD output indicator
- Two available mounting options: DIN rail or socket (8 or 11 pin)
- Universal AC/DC Supply voltage timer available
- Selectable no-voltage start, reset, gate and check inputs expand capabilities
- Time limit or instantaneous output, select SPDT or DPDT models (3 A @ 250 VAC)
- Panel mounting adapters, sockets and accessories available



## Specifications

- Timing functions: Multi-mode: ON-delay, Repeat cycle, Signal Interval/OFF-delay, Signal-OFF delay (I & II), Interval, Cycle and Signal ON-delay/OFF-delay, ON-delay only
- Timing ranges: 7 ranges: 0.1 seconds to 9990 hours
- Repeat accuracy:  $\pm 0.3\%$  of range,  $\pm 0.05$  second
- Control output: 10 mA to 3 A at 250 VAC

## Solid-State Timers with 8 Selectable Functions

Dimensions H x W x D mm	Supply voltage	Output type	Output rating	Inputs	Input rating	Connection type	Model
48 x 48 x 89	24 to 240 VAC, 50/60 Hz,	Relay	SPDT, 3 A at 250 VAC	Start, Reset, Gate	No-voltage	11-pin socket	H3CA-A
75 x 45 x 101	12 to 240 VDC					Front mounted screw terminals	H3CA-FA

## Solid-State Timers - ON-delay Only

Dimensions H x W x D mm	Supply voltage	Output type	Output rating	Inputs	Input rating	Connection type	Model
48 x 48 x 89	Specify 24 VAC, 100/110/120 VAC, or 200/220/240 VAC, 50/60 Hz	Relay (time limit or instantaneous)	SPDT, 3 A at 250 VAC	Start, Reset, Gate	No-voltage	8-pin socket	H3CA-8H
	Specify 12, 24, 48 or 110 VDC	Relay					H3CA-8

## 1/16 DIN Analog-Set Timer

- Use for delay timing, repeatable cycles or duration (interval) timing
- Select 4 (8-pin) or 6 (11-pin) function models to handle most applications
- Repeat cycle models with independent ON and OFF periods available
- Power-OFF delay models available
- 5 A DPDT relay switches when timing cycle completes
- Short, 80 mm (3.15 inch) panel mounting depth with socket allows space-efficient control panel design



## Ordering Information

### Multi-Mode Timers H3CR-A

Quick Link

T323

omron247.com

Output	Number of pins	Supply voltage	Time range	Operating mode	Model
Relay DPDT	11	100 to 240 VAC/ 100 to 125 VDC	0.05 s to 300 h	On-delay Flicker OFF start Flicker ON start Signal ON/OFF-delay Signal OFF-delay Interval Signal ON/OFF-delay II One-shot	H3CR-A AC100-240/DC100-125
		24 to 48 VAC/ 12 to 48 VDC			H3CR-A AC24-48/DC12-48
	8	100 to 240 VAC/ 100 to 125 VDC			H3CR-A8 AC100-240/DC100-125
		24 to 48 VAC/ 12 to 48 VDC			H3CR-A8 AC24-48/DC12-48
		100 to 240 VAC/ 100 to 125 VDC			H3CR-A8E AC100-240/DC100-125
		24 to 48 VAC/VDC			H3CR-A8E AC24-48/DC12-48

### Twin Timers (Repeat Cycle) H3CR-F

Quick Link

T336

omron247.com

Output	Number of pins	Supply voltage	Time range	Operating mode	Model
Relay DPDT	11	100 to 240 VAC	0.05 s to 30 h	Flicker OFF start (When timing starts the off output indicator will illuminate. On time and off time can be independently set)	H3CR-F 100-240AC/100-125DC
		24 VAC/VDC			H3CR-F 24-48AC/12-48DC
	8	100 to 240 VAC			H3CR-F8 100-240AC/100-125DC
		24 VAC/VDC			H3CR-F8 24-48AC/12-48DC

### Power Off Delay Timers H3CR-H

See datasheet.

Quick Link

T337

omron247.com

## Analog-Set Relay Timers with Multiple Operating Modes

- Space-saving and easy to operate
- Miniature timer offers selectable timing modes
- Seconds/minutes timing range models in stock; minutes/hours models available
- Monitor relay status using independent Power-ON and Time-Up indicators
- Socket-mount timers simplify installation and maintenance
- Sockets, hold-down clips and mounting accessories available separately



### Specifications

- Supply voltage: 100-120 VAC, 200-230 VAC, or 24 VAC, 50/60 Hz; 24 VDC
- Timing functions: ON-delay, Interval and Repeat cycle with OFF-start or ON-start (DIP switch selectable)
- Timing ranges: 4 ranges: 0.1 second to 10 minutes; 0.1 minute to 10 hours
- Repeat accuracy:  $\pm 1\%$  FS max.
- Control output: DPDT, 5 A at 250 VAC (H3YN-2), 4PDT, 5 A at 250 VAC (H3YN-4)

# H3JA Solid State Timers

## Economical, Compact, Plug-in Timer

- ON-delay time limit operation with automatic resetting
- DIN size (36 x 36 mm), fits standard 8-pin socket
- Wide choice of time ranges: 1, 3, 5, 10, 30, 60 seconds/3, 5, 10, 30, 60 minutes/3 hours
- Time-limit 5 A DPDT contact models stocked; 7 A SPDT models available
- Dual LEDs indicate power and output status
- Large transparent setting knob
- Surface, flush and DIN track mountable



### Specifications

- Supply voltage: 100-120 VAC, 200-240 VAC, or 24 VAC, 50/60 Hz; 12 VDC or 24 VDC
- Timing functions: ON-delay, time limit; automatic resetting
- Timing ranges: 0.1 to 1 second, 0.3 to 3 seconds, 0.5 to 5 seconds, 1 to 10 seconds, 3 to 30 seconds, 6 to 60 seconds, 0.3 to 3 minutes, 0.5 to 5 minutes
- Repeat accuracy:  $\pm 2\%$  max.
- Control output: DPDT, 100 mA to 5 A at 125/250 VAC (resistive load)



## DIN 22.5 mm Width Timers, Track-Mount, Analog Set

Space-saving slim track-mount timers easily fit into panel designs. Multi-function models with switch selectable dual time limit and instantaneous outputs satisfy multiple design needs with a single part, reducing your stock.



### Features

- 4- and 8-function models
- All sub-series include models with 12 VDC power supply
- Finger-safe terminal block and captive screws according to EN 50274
- EMC (EN 61812-1) compliance for application in heavy or light industrial, commercial and residential environments



### Ordering Information

Type	Time specifications	Operating modes	Connection type	Inputs	Output type	Supply voltage	Model
H3DK-M series 8-mode timer	0.1 to 1.2 s 1 to 12 s 10 to 120 s 1 to 12 min 10 to 120 min 1 to 12 hr 10 to 120 hr 100 to 1,200 hr	Timer Mode A ON Delay B: Repeat cycle OFF start B2: Repeat cycle ON start C: Signal ON/OFF Delay D: Signal OFF Delay E: Interval G: Signal ON/OFF delay J: One-shot output	9 screw terminals	Voltage input	Contact output (DPDT time-limit or SPDT time-limit + instantaneous SPDT), switch selected	24 to 240 VAC/VDC	H3DK-M2
						12 VDC	H3DK-M2A
					Contact output (SPDT time-limit)	24 to 240 VAC/VDC	H3DK-M1
						12 VDC	H3DK-M1A
H3DK-S Series 4-mode timer		A: ON Delay B2: Repeat cycle ON start E: Interval J: One-shot output	6 screw terminals	-	Contact output (DPDT time-limit or SPDT time-limit + instantaneous SPDT), switch selected	24 to 240 VAC/VDC	H3DK-S2
						12 VDC	H3DK-S2A
					Contact output (SPDT time-limit)	24 to 240 VAC/VDC	H3DK-S1
						12 VDC	H3DK-S1A
H3DK-F Repeat cycle timer		Repeat cycle, ON start, Independent ON and OFF time settings	6 screw terminals	-	Contact output (SPDT time-limit)	24 to 240 VAC/VDC	H3DK-F
						12 VDC	H3DK-FA

## Ultra-slim 17.5 mm Timers, Track-Mount Analog Set

- Eight operating modes (H3DS-M) and four operating modes (H3DS-S) to cover a wide range of applications
- Offers wide time setting range of 0.10 s to 120 h
- Smart Dial/Selector-Locking Mechanism prevents the dials and selectors on the timer's front panel from being operated without authorization (can only be unlocked and locked with an optional pen-type Lock Key)
- Additional single function models available: Repeat cycle independent ON/OFF, ON-delay, ON-delay timer 2 wire
- Finger protection terminal block prevents shock, meets VDE0106/P100
- High immunity to inverter noise



## Specifications

- Supply voltage: 24 to 230 VAC/24 to 48 VDC
- Timing functions: ON-delay (Signal or Power); Repeat-cycle OFF-start (Signal or Power); Repeat-cycle ON-start (Signal or Power); Signal ON/OFF-delay; Signal OFF-delay; Interval (Signal or Power); Signal ON/OFF-delay; One-shot (Signal or Power)
- Timing ranges: 0.1 to 1.2 s, 1 to 12 s, 0.1 to 1.2 min., 1 to 12 min., 0.1 to 1.2 h, 1 to 12 h, 10 to 120 h
- Repeat accuracy:  $\pm 1\%$  max. of full scale
- Control output: 5 A at 250 VAC/30 VDC (resistive load)

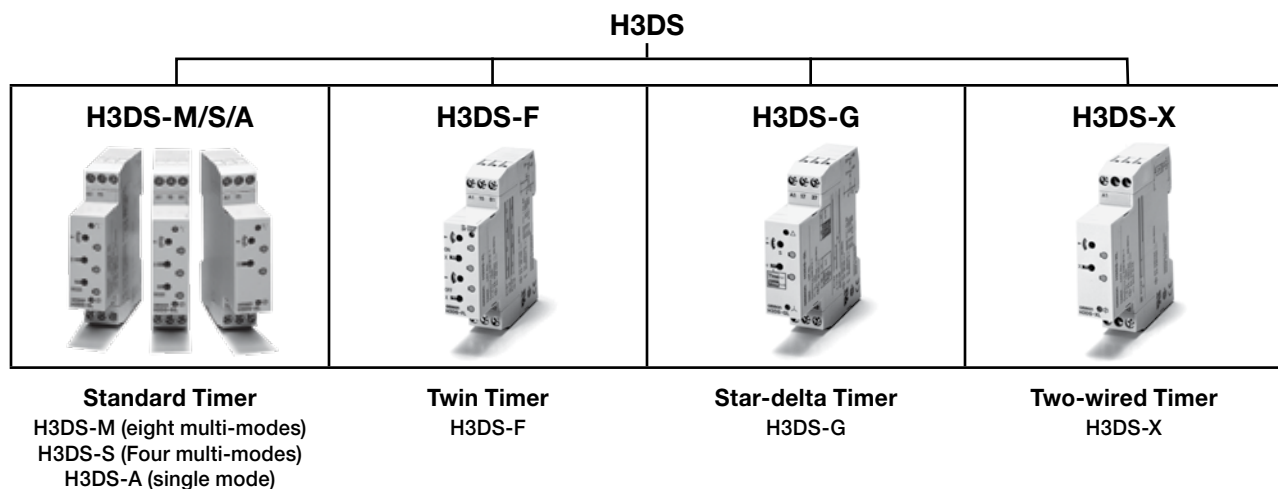



## Weekly and Yearly Timers with AM/PM Display

- Control lighting, HVAC systems and production equipment for energy saving operation
- Independent Day Keys provide easier operation
- Temporary holiday setting function makes it easy to turn OFF output for holidays and non-operating days
- Easy-to-use, prompted programming with test mode for easy program checking
- Automatic or manual operation following power failure
- Field-adjustable ON/OFF, cycle and pulse output
- Battery back-up for memory protection
- 2-circuit models include time counter and total counter functions with alarm indicator
- Compact DIN size 72 x 72 mm
- Protective cover and other accessories available separately



## Ordering Information

Control cycle	Number of outputs	Temperature compensation	Mounting method	Supply voltage	Model
Weekly	2 circuits	N	Flush Mounting	100 to 240 VAC	H5S-WB2
		N		24 VDC	H5S-WB2D
		N	Surface Mounting/Track Mounting	100 to 240 VAC	H5S-WFB2
		N		24 VDC	H5S-WFB2D
Yearly	2 circuits	Y	Flush Mounting	100 to 240 VAC	H5S-YB2-X
		Y		24 VDC	H5S-YB2D-X
		Y	Surface Mounting/Track Mounting	100 to 240 VAC	H5S-YFB2-X
		Y		24 VDC	H5S-YFB2D-X
	4 circuits	Y	Flush Mounting	100 to 240 VAC	H5S-YB4-X
		Y		24 VDC	H5S-YB4D-X
		Y	Surface Mounting/Track Mounting	100 to 240 VAC	H5S-YFB4-X
		Y		24 VDC	H5S-YFB4D-X

# H5L Digital Weekly Time Switch

Quick Link

T334

omron247.com

## 1/4 DIN Size Weekly Timer, Easy Programming and Large Display

- Set programs with just five switches
- 24 program steps available
- Two independent 15 A control circuits
- Manual override switch for each output
- 10-year battery backup for memory
- Large, easy-to-read LCD display
- Multiple-day operation
- Designed for track mounting; panel and surface mounting hardware included



### Specifications

- Supply voltage: 100 to 240 VAC
- Timing functions: Weekly timer, 24 hrs x 7 days, ON or OFF programming
- Timing ranges: 00:00 to 23:59 (hours: minutes), one minute cycle minimum
- Repeat accuracy:  $\pm 0.01\%$ ,  $\pm 0.05$  s max.
- Control output: 15 A at 250 VAC (resistive load)

# H5F Digital Daily Time Switch

Quick Link

T333

omron247.com

## 1/16 DIN Size Timer with Simple Programming

- Control up to 12 ON/OFF operations per day (24 for pulse output operation) for one independent circuit
- Special holidays can be handled easily with the holiday setting function
- Adjustments for sudden schedule changes can be made easily using output override and automatic return operation
- Operation program can be easily checked with the program check function
- Enables pulse output operation and summer time setting
- Incorporates finger-safe terminals
- Flush, surface, and DIN track mounting options



### Specifications

- Supply voltage: 100 to 240 VAC
- Timing functions: Daily timer, ON or OFF programming
- Timing ranges: 24 h x 7 days (Operation days can be specified) 1 to 59 s, or 1 to 60 min. Pulse-output operation (Pulse width can be set in units of 1 s from 1 to 59 s and in units of 1 min from 1 to 60 min)
- Repeat accuracy:  $\pm 0.01\%$ ,  $\pm 0.05$  s max.
- Control output: SPST-NO contact, 15 A at 250 VAC, resistive load. 10 A at 24 VDC, resistive load. Minimum applied load: 100 mA at 5 VDC (failure level: P, reference value).

## Advanced 1/16 DIN Size Preset Counters

- Space-saving counter solves most counting and positioning applications
- Small and flexible: Only 59 mm depth (24 VAC/VDC) or 78 mm depth (100-240 VAC)
- Waterproof, dust-proof front panel (UL508 Type 4X and IP66)
- High visibility character height: 4 digit models (12 mm) and 6 digit models (10 mm)
- Protect settings with 5 levels of key access
- Built-in Tachometer functions:
  - One-input measurement
  - Independent measurement for 2 inputs
  - Differential input for 2 inputs
  - Absolute ratio for 2 inputs
  - Error ratio between 2 inputs



- Isolated power supply and input circuits prevent unwanted circuit paths
- Built-in output counter supports preventive maintenance
- Switchable display colors show output status changes at a glance

## Ordering Information

Classification	Counting action	Settings	Display digits	Output	Supply voltage	Model		
Preset counter	1-stage preset counter Total and preset counter	1-stage	4 digits	Contact output (SPDT)	100 to 240 VAC	H7CX-A114-N		
			6 digits		12 to 24 VDC/24 VAC	H7CX-A114D1-N		
			4 digits		100 to 240 VAC	H7CX-A11-N		
			6 digits		12 to 24 VDC/24 VAC	H7CX-A11D1-N		
			4 digits		100 to 240 VAC	H7CX-A4-N		
			6 digits		12 to 24 VDC/24 VAC	H7CX-A4D-N		
			6 digits		100 to 240 VAC	H7CX-A-N		
6 digits	12 to 24 VDC/24 VAC	H7CX-AD-N						
Preset counter/ Tachometer	1-stage preset counter 2-stage preset counter Total and preset counter Batch counter Dual counter Twin counter	2-stage	4 digits	Contact output (SPST + SPDT)	100 to 240 VAC	H7CX-A4W-N		
			6 digits				100 to 240 VAC	H7CX-AW-N
			6 digits				12 to 24 VDC/24 VAC	H7CX-AWD1-N
	1-stage preset counter 2-stage preset counter Total and preset counter Batch counter Dual counter Twin counter		6 digits		Contact (SPDT)	100 to 240 VAC	H7CX-AU-N	
			6 digits		Transistor (SPST)	12 to 24 VDC/24 VAC	H7CX-AUD1-N	
			6 digits		Transistor (SPST)	12 to 24 VDC/24 VAC	H7CX-AUD1-N	
Tachometer	Tachometer	1-stage (1 input and output)	4 digits	Contact output (SPDT)	100 to 240 VAC	H7CX-R11-N		
			6 digits		12 to 24 VDC/24 VAC	H7CX-R11D1-N		
		1-stage (2 inputs and outputs)	4 digits	Contact output (SPDT + SPST)	100 to 240 VAC	H7CX-R11W-N		
			6 digits		12 to 24 VDC/24 VAC	H7CX-R11WD1-N		

## Subminiature Totalizer, Time Counter, LCD Tachometer

The self-powered H7E series features a large display with 8.6 mm character height. It includes models with backlight for improved visibility in dimly lit places. The 1/32 DIN size family includes total counters, time counters and tachometers.



- 1/32 DIN size: 24 H x 48 W x 55.5 D mm
- Black or light-grey housing
- Make all basic settings with a DIP switch
- 8 digits (H7EC), 7 digits (H7ET), 5 digits (H7ER), 8.6 mm character height
- Dual input speed: 30 Hz <-> 1 kHz (H7EC)
- Dual time ranges in each model (H7ET)
- Dual revolution display (H7ER)

## Ordering Information

### H7EC Count Totalizer

Quick Link **T423** omron247.com

Count input	Max. counting speed	Display	Model	
			Light grey body	Black body
No-voltage	30 Hz <-> 1 kHz (switchable)	7-segment LCD	H7EC-N	H7EC-N-B
PNP/NPN universal DC voltage input	30 Hz <-> 1 kHz (switchable)	7-segment LCD	H7EC-NV	H7EC-NV-B
		7-segment LCD with backlight	H7EC-NV-H	H7EC-NV-BH
AC/DC multi-voltage input	20 Hz	7-segment LCD	H7EC-NFV	H7EC-NFV-B

### H7ET Time Totalizer

Quick Link **T424** omron247.com

Timer input	Display	Model			
		Time range 999999.9h <-> 3999d23.9h (switchable)		Time range 999h59m59s <-> 9999h59.9m (switchable)	
		Light grey body	Black body	Light grey body	Black body
No-voltage input	7-segment LCD	H7ET-N	H7ET-N-B	H7ET-N1	H7ET-N1-B
PNP/NPN universal DC voltage input	7-segment LCD	H7ET-NV	H7ET-NV-B	H7ET-NV1	H7ET-NV1-B
	7-segment LCD with backlight	H7ET-NV-H	H7ET-NV-BH	H7ET-NV1-H	H7ET-NV1-BH
AC/DC multi-voltage input	7-segment LCD	H7ET-NFV	H7ET-NFV-B	H7ET-NFV1	H7ET-NFV1-B

### H7ER Tachometer

Quick Link **T425** omron247.com

Count input	Display	Model			
		Max. revolutions displayed (applicable encoder resolution)			
		1,000 s-1 (1 pulse/rev.) 1,000 min-1 (60 pulse/rev.)		1,000.0 s-1 (10 pulse/rev) 1,000.0 min-1 (600 pulse/rev) <-> 10,000 min-1 (60 pulse/rev) (switchable)	
		Light grey body	Black body	Light grey body	Black body
No-voltage input	7-segment LCD	H7ER-N	H7ER-N-B	-	-
PNP/NPN universal DC voltage input	7-segment LCD	H7ER-NV	H7ER-NV-B	H7ER-NV1	H7ER-NV1-B
	7-segment LCD with backlight	H7ER-NV-H	H7ER-NV-BH	H7ER-NV1-H	H7ER-NV1-BH

# H7BX Digital Counters

Quick Link

T427

omron247.com

## 72 x 72 mm Multi-Function Counter with a Bright, Easy-to-view, Negative Transmissive LCD

- Provides a total and preset counter, batch counter, dual counter, and tachometer
- Large highly visible display with backlit transmissive LCD
- Selectable display color (red/green) enables checking output status at a distance
- Easy operation with a key for each digit
- Perform all basic settings with a DIP switch



- Wide range of inputs accepted for NPN/PNP inputs (multi-inputs) and 2-wire DC sensors
- Degree of protection: IP54 equivalent (front section only)

### Specifications

- Supply voltage: 100 to 240 VAC, 24 VAC/12 to 24 VDC
- Inputs: Voltage or no-voltage inputs; 12 VDC external power supply
- Ranges: Counting -99,999 to 999,999 (6-digit); tachometer 0 to 999,999 (6 digits)
- Control output: Contact output: 3 A at 250 VDC/30 VDC (resistive load); transistor output: 100 mA max. at 30 VDC max.
- Output functions: One-shot and sustained outputs with up to 12 user selections
- Reset time: 1 ms or 20 ms selectable

# H7CN Digital Counters

Quick Link

T428

omron247.com

## 1/16 DIN, Single Preset Counter with Four-Digit LED Display

- Simple to set and operate
- Easy-to-read 10 mm-high LED display
- Contact (SPST-NO or SPDT) or solid-state (open-collector) outputs
- Single counting speed per model: 30 cps models stocked; 5 kcps available
- Separate UP, DOWN and REVERSIBLE counting models
- Memory protection circuit available on AC models
- 8-pin or 11-pin round socket models available
- Panel-mount adapter, sockets and accessories available separately



### Specifications

- Supply voltage: 100-240 VAC, 50/60 Hz
- Counting functions: 1-stage (single preset) UP counter
- Counting ranges: 0 to 9,999 (4-digit)
- Output functions: Sustained output until reset

## Compact Count and Time Totalizers

- Large easy to read 8.5 mm transmissive LCD displays
- NEMA protection when used with Y92S-33 rubber gasket
- High-visibility, negative transmissive LCD display with built-in LED backlight
- Short (80 mm) body
- Switch between NPN and PNP operation
- Units can be externally or manual reset
- Dimensions: 24 H x 44 W x 80 D mm



## Ordering Information

### H7GP-C Totalizing Counter

Count input	Max. counting speed	Counting Range	Display	Supply Voltage	Model	
					Light grey body	Black body
NPN or PNP	30 cps or 5 cps (selectable)	99999.6	8 mm, 6-digit	100 to 240 VAC	H7GP-C	H7GP-CB
				12 to 24 VDC	H7GP-CD	H7GP-CDB

### H7GP-T Time Totalizer

Count input	Max. counting speed	Time Range	Display	Supply Voltage	Model	
					Light grey body	Black body
NPN or PNP	30 cps or 5 cps (selectable)	99999.9 h or 99 h 59 m 59 s	8 mm, 6-digit	100 to 240 VAC	H7GP-T	H7GP-TB
				12 to 24 VDC	H7GP-TD	H7GP-TDB



## Compact Count and Time Totalizers

- Large easy to read displays: 6-digit (15 mm); 8-digit (12 mm) models
- NEMA protection when used with Y92S-33 rubber gasket
- High-visibility, negative transmissive LCD display with built-in LED backlight
- Short (66 mm) body
- Switch between NPN and PNP operation
- Units can be externally or manual reset
- Dimensions: 32 H x 67.7 W x 65.8 D mm



## Ordering Information

### H7HP-A Counter/Timer

Count input	Max. counting speed	Time Range	Display	Supply Voltage	Model	
					Light grey body	Black body
NPN or PNP	30 cps or 5 cps (selectable)	99999.9 h or 99 h 59 m 59 s	15 mm, 6-digit	100 to 240 VAC	H7HP-A	H7HP-AB
				12 to 24 VDC	H7HP-AD	H7HP-ADB

### H7HP-C Totalizer

Count input	Max. counting speed	Counting Range	Display	Supply Voltage	Model	
					Light grey body	Black body
NPN or PNP	30 cps or 5 cps (selectable)	99999999	12 mm, 8-digit	100 to 240 VAC	H7HP-C8	H7HP-C8B
				12 to 24 VDC	H7HP-C8D	H7HP-D8D8

# Timers and Counters

---

## Contents

Selection Guide		W-ii
K3HB -X, -H, -V, -S	Process, Temperature, Weighing and Linear Sensor Indicators	W-1
K3HB -C, -P, -R	Rotary Pulse, Timer Interval and Up-/Down-Counting Pulse Indicators	W-2
K3MA -J, -L, -F	Process, Temperature, Frequency/Rate Meters with Built-in Outputs	W-3
K3GN	1/32 DIN Process Meter with Relay or Transistor Output	W-3

W

## LOOKING FOR PERFECT MEASURING & READ-OUT?

### K3HB-V – For perfect weighing



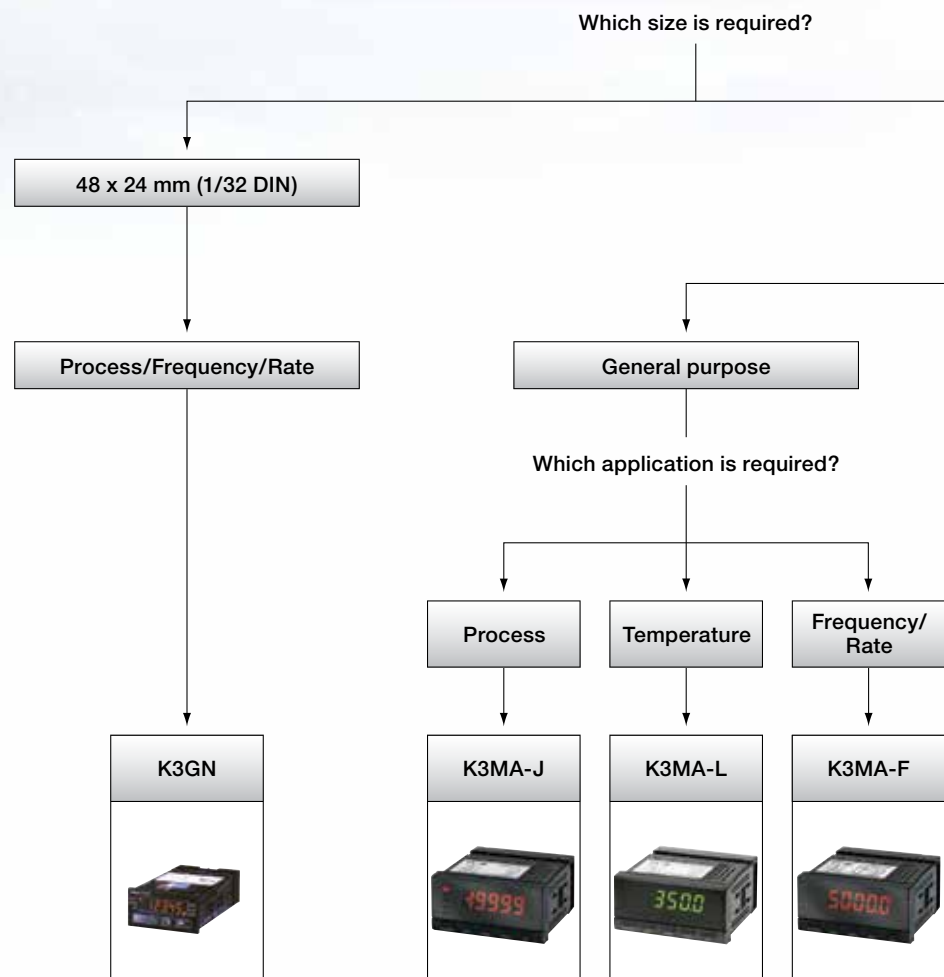

With our K3HB series, we cover a wide range of applications. One of them is the weighing indicator which performs perfect measurement in any weighing application. The instrument can be equipped with a load-cell power supply of 10 V/100 mA. Several option boards for communication, contact output boards or event inputs are also available. On top of these, you can get direct DeviceNet communication.

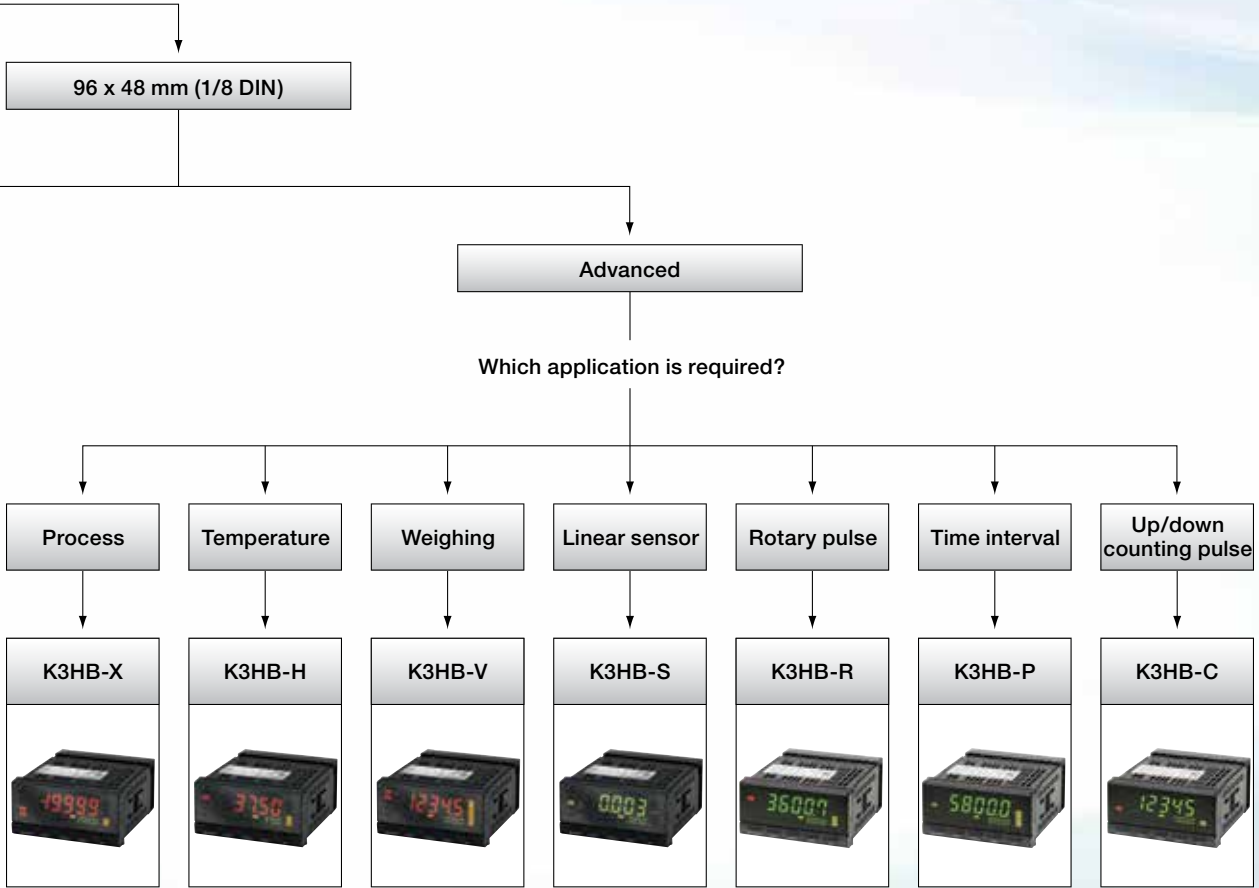
- High-speed sampling 20 ms
- Equipped with position meter
- Two-color display for easy recognition









# Selection Table

Category		Multifunctional Digital Panel Indicator	Process Indicator	Temperature Indicator	Frequency/Rate Indicator
Selection Criteria					
	Model	K3GN	K3MA-J	K3MA-L	K3MA-F
	Size	1/32 DIN	1/8 DIN	1/8 DIN	1/8 DIN
Features	Color change display	■	■	■	■
	Number of digits	5	5	4	5
	Leading zero suppression	■	■	■	■
	Forced zero function	■	■	■	■
	Min./max. hold function	■	■	■	■
	Average processing	■	■	■	■
	User selectable inputs	■	■	■	■
	Start-up compensating time	■	—	—	■
	Key protection	■	■	■	■
	Decimal pt. position setting	■	■	■	■
	Accuracy	±0.1% of full scale			
	Input range	0 to 20 mA, 4 to 20 mA or 0 to 5 V, 1 to 5 V, -5 to 5 V, -10 to 10 V or 0 to 30 Hz or 0 to 5 kHz	0 to 20 mA, 4 to 20 mA or 0 to 5 V, 1 to 5 V, -5 to 5 V, -10 to 10 V	Pt100, JPt100 or thermocouple K, J, T, E, L, U, N, R, S, B	0 to 30 Hz or 0 to 5 kHz
	Sample rate	250 ms	250 ms	500 ms	—
	Features	Remote/local processing, parameter initialization, programmable output configuration, process value hold	Teaching, comparative output pattern selection, parameter initialization, programmable output configuration, process value hold	Programmable output configuration, process value hold	Teaching, comparative output pattern selection, programmable output configuration, process value hold
	Sensor power supply	—	—	—	■
Front protection – IP rating	IP66/NEMA 4	IP66/NEMA 4	IP66/NEMA 4	IP66/NEMA 4	
Supply voltage	24 VDC	24 VAC/VDC or 100 to 240 VAC	24 VAC/VDC or 100 to 240 VAC	24 VAC/VDC or 100 to 240 VAC	
Inputs	NPN	■	—	—	■
	PNP	■	—	—	■
	Temperature	—	—	—	—
	Contact	—	—	—	■
	Voltage pulse	—	—	—	■
	Load cell	—	—	—	—
	DC voltage	■	■	—	—
	DC current	■	■	—	—
	AC voltage	—	—	—	—
	AC current	—	—	—	—
Outputs	Relay	■	■	■	■
	NPN	■	—	—	—
	PNP	■	—	—	—
	Linear	—	—	—	—
	BCD	—	—	—	—
	Comms	■	—	—	—



■ Standard    □ Available    — No/not available

# Digital Panel Meters

Category		Process Indicator	Temperature Indicator	Weighing Indicator	Linear Sensor Indicator
Selection Criteria					
	Model	K3HB-X	K3HB-H	K3HB-V	K3HB-S
	Size	1/8 DIN	1/8 DIN	1/8 DIN	1/8 DIN
Features	Color change display	■	■	■	■
	Number of digits	5	5	5	5
	Leading zero suppression	■	■	■	■
	Forced zero function	■	■	■	■
	Min./max. hold function	■	■	■	■
	Average processing	■	■	■	■
	User selectable inputs	■	■	■	■
	Start-up compensating time	—	—	—	—
	Key protection	■	■	■	■
	Decimal pt. position setting	■	■	■	■
	Accuracy	±0.1% of full scale (DC voltage & DC current), ±0.5% of full scale (AC voltage & AC current)	Thermocouple: ±0.3% of full scale, Pt-100: ±0.2% of full scale	±0.1% of full scale	One input: ±0.1% of full scale, two inputs: ±0.2% of full scale
	Input range	0.000 to 10.000 A 0.0000 to 19.999 mA -199.99 to 199.99 mA 4.000 to 20.000 mA 0.0 to 400.0 V 0.0000 to 1.999 V -199.99 to 199.99 V 1.0000 to 5.0000 V	Pt100, thermocouple K, J, T, E, L, U, N, R, S, B, W	0.00 to 199.99 mV, 0.000 to 19.999 mV, 100.00 mV, 199.99 mV	0 to 20 mA, 4 to 20 mA, 0 to 5 V, -5 to 5 V, -10 to 10 V
	Sample rate	20 ms	20 ms	20 ms	0.5 ms
	Features	Scaling, teaching, averaging, output hysteresis, output OFF-delay, output test, bank selection, reset, comparative output	Scaling, teaching, averaging, output hysteresis, output OFF-delay, output test, bank selection, reset, comparative output	Scaling, teaching, averaging, output hysteresis, output OFF-delay, output test, bank selection, reset, comparative output	Scaling, 2-input calculation, teaching, averaging, output hysteresis, output OFF-delay, output test, bank selection, reset, comparative output
	Sensor power supply	<input type="checkbox"/>	<input type="checkbox"/>	<input type="checkbox"/>	<input type="checkbox"/>
Front protection – IP rating	IP66/NEMA 4	IP66/NEMA 4	IP66/NEMA 4	IP66/NEMA 4	
Supply voltage	100 to 240 VAC or 24 VAC/VDC	100 to 240 VAC or 24 VAC/VDC	100 to 240 VAC or 24 VAC/VDC	100 to 240 VAC or 24 VAC/VDC	
Inputs	NPN	<input type="checkbox"/>	<input type="checkbox"/>	<input type="checkbox"/>	<input type="checkbox"/>
	PNP	<input type="checkbox"/>	<input type="checkbox"/>	<input type="checkbox"/>	<input type="checkbox"/>
	Temperature	—	■	—	—
	Contact	—	—	—	—
	Voltage pulse	—	—	—	—
	Load cell	—	—	■	—
	DC voltage	<input type="checkbox"/>	—	—	■
	DC current	<input type="checkbox"/>	—	—	■
	AC voltage	<input type="checkbox"/>	—	—	—
AC current	<input type="checkbox"/>	—	—	—	
Outputs	Relay	<input type="checkbox"/>	<input type="checkbox"/>	<input type="checkbox"/>	<input type="checkbox"/>
	NPN	<input type="checkbox"/>	<input type="checkbox"/>	<input type="checkbox"/>	<input type="checkbox"/>
	PNP	<input type="checkbox"/>	<input type="checkbox"/>	<input type="checkbox"/>	<input type="checkbox"/>
	Linear	<input type="checkbox"/>	<input type="checkbox"/>	<input type="checkbox"/>	<input type="checkbox"/>
	BCD	—	—	—	—
	Comms	<input type="checkbox"/>	<input type="checkbox"/>	<input type="checkbox"/>	<input type="checkbox"/>

■ Standard    □ Available    — No/not available

# Selection Table

Category		Up/Down Counting Pulse Indicator	Time Interval Indicator	Rotary Pulse Indicator
Selection Criteria				
	Model	K3HB-C	K3HB-P	K3HB-R
	Size	1/8 DIN	1/8 DIN	1/8 DIN
Features	Color change display	■	■	■
	Number of digits	5	5	5
	Leading zero suppression	■	■	■
	Forced zero function	■	■	■
	Min./max. hold function	■	■	■
	Average processing	■	■	■
	User selectable inputs	■	■	■
	Start-up compensating time	—	—	■
	Key protection	■	■	■
	Decimal pt. position setting	■	■	■
	Accuracy	—	±0.08% rgd ±1 digit	±0.006% rgd ±1 digit ±0.02% rgd ±1 digit
	Input range	No voltage contact: 30 Hz, voltage pulse: 50 kHz, open collector: 50 kHz	No voltage contact: 30 Hz, voltage pulse: 50 kHz, open collector: 50 kHz	No voltage contact: 30 Hz, voltage pulse: 50 kHz, open collector: 50 kHz
	Sample rate	—	—	—
	Features	Scaling, measurement operation selection, output hysteresis, output OFF-delay, output test, display value selection, display color selection, key protection, bank selection, display refresh period, maximum/minimum hold, reset	Scaling, measurement operation selection, output hysteresis, output OFF-delay, output test, teaching, display value selection, display color selection, key protection, bank selection, display refresh period, maximum/minimum hold, reset	Scaling, measurement operation selection, averaging, previous average value comparison, output hysteresis, output OFF-delay, output test, teaching, display value selection, display color selection, key protection, bank selection, display refresh period, maximum/minimum hold, reset
	Sensor power supply	<input type="checkbox"/>	<input type="checkbox"/>	<input type="checkbox"/>
	Front protection – IP rating	IP66/NEMA 4	IP66/NEMA 4	IP66/NEMA 4
Supply voltage	100 to 240 VAC or 24 VAC/VDC	100 to 240 VAC or 24 VAC/VDC	100 to 240 VAC or 24 VAC/VDC	
Inputs	NPN	■	■	■
	PNP	■	■	■
	Temperature	—	—	—
	Contact	—	—	—
	Voltage pulse	■	■	■
	Load cell	—	—	—
	DC voltage	—	—	—
	DC current	—	—	—
	AC voltage	—	—	—
AC current	—	—	—	
Outputs	Relay	<input type="checkbox"/>	<input type="checkbox"/>	<input type="checkbox"/>
	NPN	<input type="checkbox"/>	<input type="checkbox"/>	<input type="checkbox"/>
	PNP	<input type="checkbox"/>	<input type="checkbox"/>	<input type="checkbox"/>
	Linear	<input type="checkbox"/>	<input type="checkbox"/>	<input type="checkbox"/>
	BCD	<input type="checkbox"/>	<input type="checkbox"/>	<input type="checkbox"/>
	Comms	<input type="checkbox"/>	<input type="checkbox"/>	<input type="checkbox"/>

■ Standard    □ Available    — No/not available



## Process, Temperature, Weighing and Linear Sensor Indicators

These indicators with analog input, feature a color change display for easy monitoring. K3HB series is high-speed, with a sample rate of 50 Hz, and even 2,000 Hz for K3HB-S.



- Communications: DeviceNet, RS-232C, RS-485
- 1/8 DIN size, IP66 rated NEMA 4 housing

## Ordering Information

Type of indicator	Input sensor type and range	Model
Process indicator K3HB-X	DC current input, from $\pm 199.99$ mA, to 4.000 to 20.000 mA	K3HB-XAD 100-240VAC
		K3HB-XAD 24VAC/VDC
	DC voltage input from $\pm 199.99$ V to 1.0000 to 5.0000 V	K3HB-XVD 100-240VAC
		K3HB-XVD 24VAC/VDC
Temperature indicator K3HB-H	Temperature input Pt100, thermocouple K, J, T, E, L, U, N, R, S, B, W	K3HB-HTA 100-240VAC
		K3HB-HTA 24VAC/VDC
Weighing indicator K3HB-V	Load cell input (DC low voltage input), 0.00 to 199.99 mV, 0.000 to 19.999 mV, 100.00 mV, 199.99 mV	K3HB-VLC 100-240VAC
		K3HB-VLC 24VAC/VDC

## Sensor Power Supply/Output Boards

Slot	Output		Sensor power supply	Communications	Applicable indicator types	Model
B	Relay	PASS: SPDT	12 VDC $\pm 10\%$ , 80 mA	-	K3HB-X, -H, -S	K33-CPA
	Linear current	DC0(4) - 20 mA		-	K3HB-X, -H, -S	K33-L1A
	Linear voltage	DC0(1) - 5 V, 0 to 10 V		-	K3HB-X, -H, -S	K33-L2A
	Sensor power supply only			-	K3HB-X, -H, -S	K33-A
				RS-232C	K3HB-X, -H, -S	K33-FLK1A
				RS-485	K3HB-X, -H, -S	K33-FLK3A
	Relay	PASS: SPDT	10 VDC $\pm 5\%$ , 100 mA	-	K3HB-V	K33-CPB
	Linear current	DC0(4) - 20 mA		-	K3HB-V	K33-L1B
	Linear voltage	DC0(1) - 5 V, 0 to 10 V		-	K3HB-V	K33-L2B
	Sensor power supply only			-	K3HB-V	K33-B
				RS-232C	K3HB-V	K33-FLK1B
				RS-485	K3HB-V	K33-FLK3B

## Relay/Transistor Output Boards

Slot	Output		Communications	Model
C	Relay	H/L: SPDT each	-	K34-C1
		HH/H/LL/L: SPST-NO each	-	K34-C2
	Transistor	NPN open collector: HH/H/PASS/L/LL	-	K34-T1
		PNP open collector: HH/H/PASS/L/LL	-	K34-T2
	-	-	DeviceNet	K34-DRT

## Event Input Boards

Slot	Output	Number of points	Communications	Model
DT	NPN open collector	5	M3 terminal blocks	K35-1
	PNP open collector	5	M3 terminal blocks	K35-3

## Rotary Pulse, Timer Interval and Up/Down Counting Pulse Indicators

These indicators with analog input feature a clear and easy-to-use color change display. All models are equipped with NEMA 4 IP66 housing. K3HB-R and -C are high-speed, with a color rate up to 50 kHz.

- Position meter indication for easy monitoring
- Communications: DeviceNet, RS-232C, RS-485
- Double display with 5 digits in two colors
- 1/8 DIN size, IP66 rated NEMA 4 housing



**K3HB-P**

Quick Link

**X327**

omron247.com

**K3HB-R**

Quick Link

**X328**

omron247.com

## Ordering Information

Type of indicator	Input ranges	Input sensor	Model
Rotary pulse indicator K3HB-R	No voltage contact: 30 Hz max. Voltage pulse: 50 kHz max. Open collector: 50 kHz max.	NPN input/ voltage pulse	K3HB-RNB 100-240VAC K3HB-RNB 24VAC/VDC
		PNP input	K3HB-RPB 100-240VAC K3HB-RPB 24VAC/VDC
NPN		K3HB-PNB 100-240VAC	
PNP		K3HB-PPB 100-240VAC	
Timer interval indicator K3HB-P		PNP	K3HB-CNB 24VAC/VDC
		NPN	K3HB-CNB 100-240VAC
Up/down counting pulse indicator K3HB-C		NPN	K3HB-CPB 24VAC/VDC
		PNP	K3HB-CPB 24VAC/VDC
		PNP	K3HB-CPB 100-240VAC

## Sensor Power Supply/Output Boards

Slot	Output	Sensor power supply	Communications	Model
B	Relay	12 VDC $\pm$ 10%, 80 mA	-	K33-CPA
	Linear current		-	K33-L1A
	Linear voltage		-	K33-L2A
	-		-	K33-A
	-		RS-232C	K33-FLK1A
	-		RS-485	K33-FLK3A

## Relay/Transistor Output Boards

Slot	Output	Communications	Model	
C	Relay	H/L: SPDT each	-	K34-C1
		HH/H/LL/L: SPST-NO each	-	K34-C2
	Transistor	NPN open collector: HH/H/PASS/L/LL	-	K34-T1
		PNP open collector: HH/H/PASS/L/LL	-	K34-T2
	-	-	DeviceNet	K34-DRT
	BCD + transistor	NPN open collector: HH/H/PASS/L/LL	-	K34-BCD

## Event Input Boards

Slot	Output	Number of points	Communications	Model
D	NPN open collector	5	M3 terminal blocks	K35-1
	NPN open collector	5	M3 terminal blocks	K35-3

# K3MA-J, -L, -F Digital Panel Meters

Quick Link

X324

omron247.com

## Digital Panel Meters Offer Built-in Outputs

The K3MA series is available as a process meter, a frequency/rate meter or a temperature meter. All are equipped with the same quality display and have the same short mounting depth of 80 mm.

- 1/8 DIN size housing: 97 L x 96 W x 48 H mm
- Highly visible, 2-color negative transmissive backlit LCD display
- 14.2 mm high characters



- 5 digits (-19,999 to 99,999), K3MA-L: 4 digits
- 1/8 DIN size, IP66 rated NEMA 4 housing

**K3MA-L** [Quick Link](#) **X329** [omron247.com](#)

**K3MA-F** [Quick Link](#) **X323** [omron247.com](#)

## Ordering Information

Indicator	Supply voltage	Input type and ranges	Output	Model
Process meter	100 to 240 VAC	DC voltage: 0 to 5 V, 1 to 5 V, -5 to 5 V, -10 to 10 V	2 relay contact outputs (SPST-NO)	K3MA-J-A2 100-240VAC
	24 VAC/VDC		2 relay contact outputs (SPST-NO)	K3MA-J-A2 24VAC/VDC
Temperature meter	100 to 240 VAC	Platinum-resistance thermometer: Pt100, JPt100	1 relay contact output (SPDT)	K3MA-L-C 100-240VAC
	24 VAC/VDC		1 relay contact output (SPDT)	K3MA-L-C 24VAC/VDC
Frequency/rate meter	100 to 240 VAC	Rotary pulse - No voltage: 0.05 to 30.00 Hz	2 relay contact outputs (SPST-NO)	K3MA-F-A2 100-240VAC
	24 VAC/VDC		2 relay contact outputs (SPST-NO)	K3MA-F-A2 24VAC/VDC

# K3GN Digital Panel Meters

Quick Link

X325

omron247.com

## Intelligent Digital Panel Meter, 1/32 DIN Size

The K3GN has three main functions are process meter, RPM processor/tachometer and digital data display for PC/PLC.

- 5-digit display with programmable display color, in red or green
- Very compact 1/32 DIN housing: 24 H x 48 W x 83 D mm
- 1/8 DIN size, IP66 rated NEMA 4 housing



## Ordering Information

Input type	Supply voltage	Output	Model	
			No communications	RS-485
DC voltage/current, NPN	24 VDC	Dual relays (SPST-NO)	K3GN-NDC 24 DC	K3GN-NDC-FLK 24 DC
DC voltage/current, PNP		Dual relays (SPST-NO)	K3GN-PDC 24 DC	K3GN-PDC-FLK 24 DC

# Digital Panel Meters

---

<b>Contents</b>		
Selection Guide		X-ii
<b>Monitoring Relays</b>		
K8AK-VS/ K8AK-VW	Single phase voltage monitoring relays	X-1
K8AK-AS	Single phase current monitoring relays	X-2
K8AK-AW	Single phase overcurrent/undercurrent monitoring relays	X-3
K8AK-PA/ PM/PW	3-phase voltage monitoring relays	X-4
K8AK-PH/ K8DS-PH	Phase-sequence/Phase-loss monitoring relays	X-5
K8AK-TH	Temperature monitoring relays	X-6
<b>Liquid Level Controls and Detectors</b>		
K8AK-LS	Liquid level controller	X-7
K7L-AT50	Protect your process equipment from liquid spills and leaks	X-8

X

## MONITORING RELAYS

The K8AK/K8DS series power monitoring relays can detect problems such as:



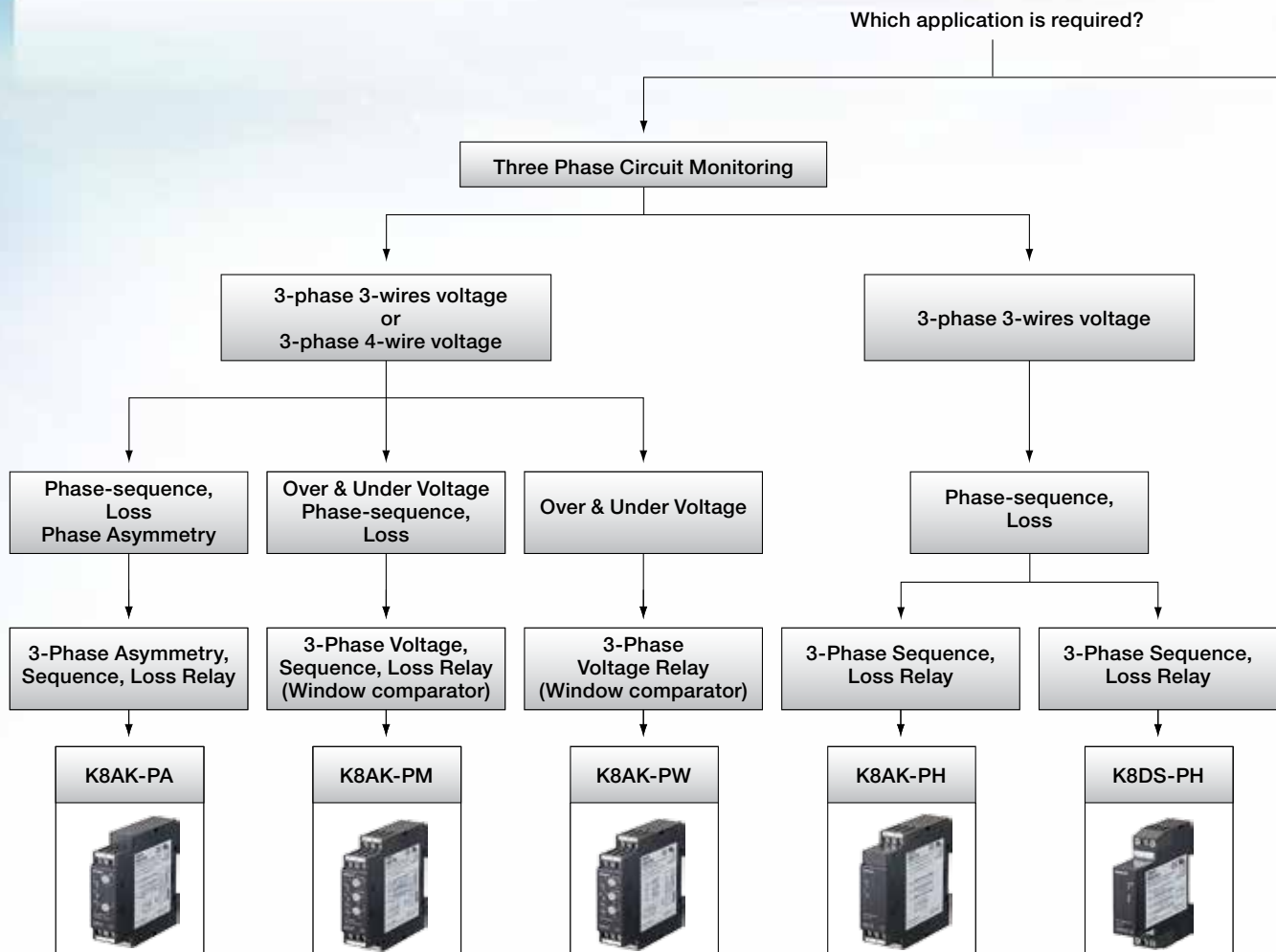

- Over- and under-currents, and over- and under-voltages
- Phase losses (where voltage is not supplied to one or more phases because of disconnected power lines, loose terminals, or contact failures)
- Phase-sequence problems (which can result, for example, in motors rotating backwards)
- Voltage asymmetries where the voltages of different phases are different because of phase losses or other causes).

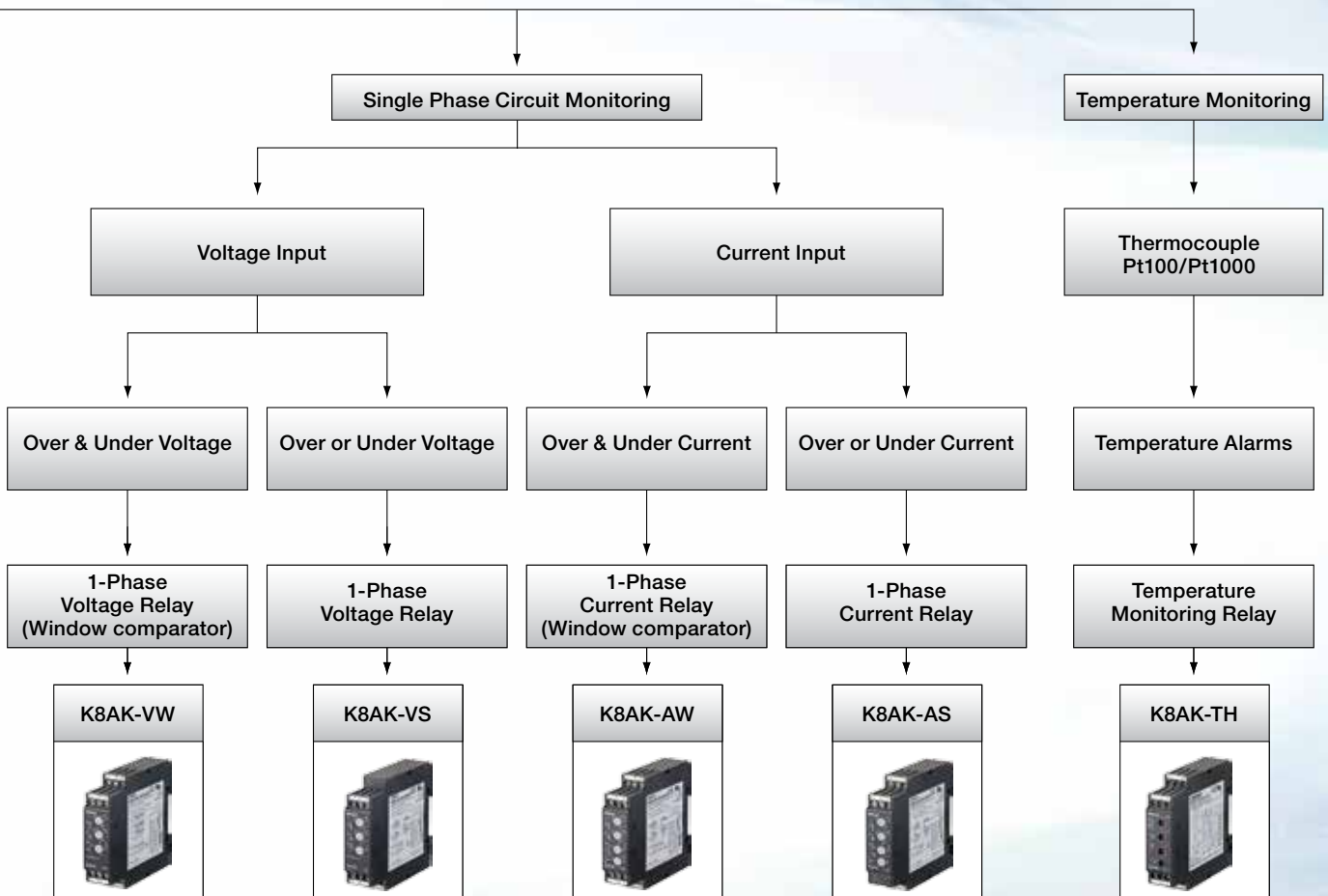
The relays are available in various single- and three-phase versions for currents up to 200 A and voltages up to 600 V. The 17.5 mm and 22.5 mm wide DIN-rail mounting devices save space in control panels.









# Selection Table

Type		Temperature	1-Phase			
						
Selection criteria	Model	<b>K8AK-TH</b>	<b>K8AK-AS</b>	<b>K8AK-AW</b>	<b>K8AK-VS</b>	<b>K8AK-VW</b>
	Mounting	DIN Rail	DIN Rail	DIN Rail	DIN Rail	DIN Rail
	Size	22.5W x 90H x 100D	22.5W x 90H x 100D	22.5W x 90H x 100D	22.5W x 90H x 100D	22.5W x 90H x 100D
	Type	Temperature Monitoring	Current Monitoring	Overcurrent/ Undercurrent Monitoring	Voltage Monitoring	Overvoltage/ undervoltage monitoring
Input	Range	• Type K, J, T, E, B, R, S Thermocouple	• 2-500 mA • 0.1-8 A • 10-200 A	• 2-500 mA • 0-5 A • 0-200 A	• 1-150 V • 20-600 V	• 1-10 V • 60-300 V
	Power Supply	100-240 VAC	100-240 VAC	100-240 VAC	100-240 VAC	100-240 VAC
	Power Supply	24 VAC/DC	24 VAC/DC	24 VAC/DC	24 VAC/DC	24 VAC/DC
	Relay SPDT	■	■	■	■	—
Output	Relay 2x SPDT	—	—	—	—	■
	Relay DPDT	—	—	—	—	—
	Reset mode: manual	—	■	■	■	■
Features	Reset Mode: Automatic	—	■	■	■	■
	Operation Time (With Timer)	—	0.1-30 Sec.	0.1-30 Sec.	0.1-30 Sec.	0.1-30 Sec.
	Startup Lock	—	■	■	■	■
	Power (Green)	■	■	■	■	■
Indicators	Relay Output (Yellow)	■	■	■	■	■
	Alarm Output (Red)	■	■	■	■	■

■ Standard    □ Available    — No/not available



# Monitoring Relays

Type		3-Phase				
						
Selection criteria	Model	K8AK-PH	K8AK-PW	K8AK-PA	K8AK-PM	K8DS-PH
	Mounting	DIN Rail	DIN Rail	DIN Rail	DIN Rail	DIN Rail
	Size	22.5W x 90H x 100D	22.5W x 90H x 100D	22.5W x 90H x 100D	22.5W x 90H x 100D	17.5W x 73H x 80D
	Type	Phase-Sequence Phase-Loss Monitoring	Voltage Monitoring	Asymmetry and Phase-Sequence Phase-Loss Monitoring	Phase-Sequence Phase-Loss Monitoring	Phase-Sequence Phase-Loss Monitoring
Input	Range	• 200-480 VAC 3-Phase	• 200-240 or 380-480 VAC 3-Phase, 3-Wire • 115-138 or 220-277 VAC 3 Phase, 4-Wire	• 200-240 or 380-480 VAC 3-Phase, 3-Wire • 115-138 or 220-277 VAC 3 Phase, 4-Wire	• 200-240 or 380-480 VAC 3-Phase, 3-Wire • 115-138 or 220-277 VAC 3 Phase, 4-Wire	• 200-480 VAC 3-Phase, 3-Wire
	Power Supply	200-480 VAC 3-Phase	200-240 or 380-480 VAC 3-Phase, 3-Wire	200-240 or 380-480 VAC 3-Phase, 3-Wire	200-240 or 380-480 VAC 3-Phase, 3-Wire	200-480 VAC 3-Phase, 3-Wire
	Power Supply	–	115-138 or 220-277 VAC 3-Phase, 4-Wire	115-138 or 220-277 VAC 3-Phase, 4-Wire	115-138 or 220-277 VAC 3-Phase, 4-Wire	–
	Relay SPDT	–	■	■	■	■
Output	Relay 2x SPDT	–	–	–	–	–
	Relay DPDT	■	–	–	–	–
	Reset mode: manual	–	–	–	–	–
	Reset Mode: Automatic	■	■	■	■	■
Features	Operation Time (With Timer)	–	–	–	–	–
	Startup Lock	–	–	–	–	–
	Power (Green)	■	■	■	■	■
	Relay Output (Yellow)	■	■	■	■	■
Indicators	Alarm Output (Red)	–	■	■	■	–

■ Standard    □ Available    – No/not available



X

## LIQUID LEVEL CONTROLS AND DETECTORS

### K8AK-LS

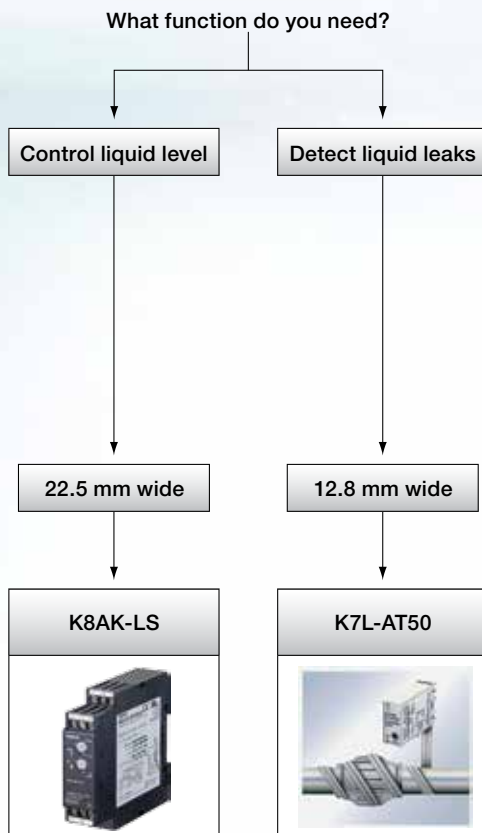
- Ideal for liquid level control for industrial facilities and equipment
- Floatless level control for liquid supply and drainage operations
- Self holding (ON or OFF) outputs can be easily selected to match application



Category	Liquid Level Controller	Leakage Detection
		
Model	<b>K8AK-LS</b>	<b>K7L-AT50</b>
Function	Floatless level control for liquid supply and drainage operations	Detects liquid spills using a conductive sensing band and socket-mount controller
Compatible liquids	Distilled water, city water, well water, industrial water, sea water, and sewage with specific impedance	Water, ammonia, and Hydrogen Peroxide
Operating resistance	10 to 100 kΩ	0 to 50 MΩ (variable)
Inputs	Conductive electrodes: SUS304 or SUS316, 1 m long segments	Sensing band: Polyethylene standard; PTFE fluororesin for high temperature and organic solvents, 10 m max. length
Supply voltage	100-120 VAC, 21 VAC/VDC	12 to 24 VDC
Dimensions	90 H x 22.5 W x 100 D mm	85.5 H x 19.5 W x 84 D mm max. in socket

# K8AK-VS and K8AK-VW

## Voltage Monitoring Relays

Quick Link

R642

omron247.com

### Overvoltage or Undervoltage Monitoring Relays featuring single or dual contacts

Designed to protect single-phase applications from overvoltage and undervoltage conditions.

- K8AK-VW features two independent SPDT (5 A @ 240 VAC) contacts
- K8AK-VS features one SPDT (5 A @ 250 VAC) contact
- Input frequency of 40 to 500 Hz supported
- Can be configured for manual or automatic reset
- Monitor output status via LED indicators
- Dimensions: 90 H x 22.5 W x 100 D mm



X

### Ordering Information

#### K8AK-VS Voltage Monitoring

Description	Features	Setting Range*	Input Voltage	Output	Model
Single phase Overvoltage or Undervoltage Relay	2 independent current adjustment knobs, Operating time adjustment knob, Startup lock adjustment knob	0 to 10 V AC/DC 0 to 30 V AC/DC 15 to 150 V AC/DC	24 VAC/VDC	"SPDT, 5 A @ 250 VAC (resistive load)"	K8AK-VS2 24 VAC/DC
			100 to 240 VAC		K8AK-VS2 100-240 VAC
		20 to 200 V AC/DC 30 to 300 V AC/DC 60 to 600 V AC/DC	24 VAC/VDC	K8AK-VS3 24 VAC/DC	
			100 to 240 VAC	K8AK-VS3 100-240 VAC	

#### K8AK-VW Overvoltage and Undervoltage

Description	Features	Setting Range*	Input Voltage	Output	Model
Single-phase Overvoltage and Undervoltage Relay	2 independent current adjustment knobs, Operating time adjustment knob, Startup lock adjustment knob, 2 independent SPDT relays	0 to 10 V AC/DC 0 to 30 V AC/DC 15 to 150 V AC/DC	24 VAC/VDC	"2 - SPDT, 5 A @ 250 VAC (resistive load)"	K8AK-VW2 24 VAC/DC
			100 to 240 VAC		K8AK-VW2 100-240 VAC
		20 to 200 V AC/DC 30 to 300 V AC/DC 60 to 600 V AC/DC	24 VAC/VDC	K8AK-VW3 24 VAC/DC	
			100 to 240 VAC	K8AK-VW3 100-240 VAC	

\*The range is selected using connected terminals.

## Ultra-Slim 22.5 mm Single Phase Current Monitoring Relays

- Monitor for overcurrent or undercurrent in industrial equipment
- Automatic and Manual resetting is supported by one relay
- Startup lock time and operating time can be set independently
- Output relay can be switched between normally open and normally closed contacts
- Monitor output status from LED indicator



## Specifications

- Operating time range: 0.1 to 30 s
- Startup lock time range: 0 to 30 s
- Output relay One SPDT (NO/NC switched using DIP switch)
- Maximum switching current: 5 A
- Ambient Operating Temperature: -4 to 140°F (-20 to 60°C)



## Ordering Information

Setting Range	Supply Voltage	Model
2 to 20 mA AC/DC	24 VAC/VDC	K8AK-AS1 24VAC/DC
10 to 100 mA AC/DC 50 to 500 mA AC/DC	100 to 240 VAC	K8AK-AS1 100-240VAC
0.1 to 1 A AC/DC	24 VAC/VDC	K8AK-AS2 24VAC/DC
0.5 to 5 A AC/DC 0.8 to 8 A AC/DC	100 to 240 VAC	K8AK-AS2 100-240VAC
10 to 100 mA AC*	24 VAC/VDC	K8AK-AS3 24VAC/DC
20 to 200 mA AC*	100 to 240 VAC	K8AK-AS3 100-240VAC

\*K8AK-AS3 is designed to be used in combination with OMRON K8AC-CT200L Current Transformer (CT). (Direct input is not possible)

## Ultra-Slim 22.5 mm Single Phase Overcurrent and Undercurrent Monitoring Relays

K8AK-AW designed to protect single-phase applications from overcurrent and undercurrent conditions.

- Startup lock time and operating time can be independently set
- Monitor output status via LED indicators
- Two independent SPDT (5 A @ 240 VAC) contacts
- Can be configured for manual or automatic reset
- Dimensions: 90 H x 22.5 W x 100 D mm



X

## Ordering Information

Setting Range	Supply Voltage	Output	Model
2 to 20 mA	24 VAC/VDC	2 – SPDT relay, 5 A @ 250 VAC	K8AK-AW1 24VAC/DC
10 to 100 mA 50 to 500 mA	100 to 240 VAC		K8AK-AW1 100-240VAC
0.1 to 1 A AC/DC	24 VAC/VDC		K8AK-AW2 24VAC/DC
0.5 to 5 A AC/DC	100 to 240 VAC		K8AK-AW2 100-240VAC
10 to 100 mA AC*	24 VAC/VDC		K8AK-AW3 24VAC/DC
20 to 200 mA AC*	100 to 240 VAC		K8AK-AW3 100-240VAC

\*K8AK-AW3 is designed to be used in combination with OMRON K8AC-CT200L Current Transformer (CT). (Direct input is not possible)

## Ultra-Slim 3-Phase Voltage Monitoring Relays

K8AK-P series can monitor a 3-phase (3-wire or 4-wire) system on a global basis.

- Monitor 3-phase voltage asymmetry (K8AK-PA)
- Monitor overvoltage, undervoltage, phase sequences and phase loss (K8AK-PM)
- Monitor overvoltages and undervoltages (K8AK-PW)
- K8AK-PA features one SPDT (5 A @ 250 VAC, resistive loads)
- K8AK-PM and -PW feature two independent SPDT (5 A @ 250 VAC, resistive loads) relays which allows for separate outputs for overvoltage and undervoltage detection
- Easy to configure global power specifications which can be configured by adjusting external DIP switches
- Output relay can be configured between normally open and normally closed contacts
- Monitor output status from LED indicators mounted on front of K8AK-P units



## Ordering Information

Description	Features	3-Phase, 3-Wire	3-Phase, 4-Wire	Output	Model
3-Phase asymmetry, phase sequence, phase loss	Asymmetry Rate and Operation time settings, Power Indicator, Relays status indicator, Alarm Indicator	200, 220, 230, 240 VAC	115, 0127, 133, 138 VAC	SPDT Relay (5 A @ 250 VAC)	K8AK-PA1
		380, 400, 415, 480 VAC	220, 230, 240, 277 VAC		K8AK-PA2
3-Phase undervoltage, overvoltage, phase sequence, phase loss	Overvoltage, Undervoltage and Operation Time settings, Relay Indicator, Alarm Indicator, Power Indicator	200, 220, 230, 240 VAC	115, 0127, 133, 138 VAC	2 independent SPDT Relays (5 A @ 250 VAC)	K8AK-PM1
		380, 400, 415, 480 VAC	220, 230, 240, 277 VAC		K8AK-PM2
3-Phase undervoltage, overvoltage	Overvoltage, Undervoltage and Operation Time settings, Relay Indicator, Alarm Indicator, Power Indicator	200, 220, 230, 240 VAC	115, 0127, 133, 138 VAC	2 independent SPDT Relays (5 A @ 250 VAC)	K8AK-PW1
		380, 400, 415, 480 VAC	220, 230, 240, 277 VAC		K8AK-PW2

# K8AK-PH and K8DS-PH

## Phase Monitoring Relays

Quick Link

R638

omron247.com

### Ultra-Slim 3-Phase Phase-sequence and Phase-loss Relays

K8AK-PH and K8DS-PH are designed to protect three-phase applications from transient phase-sequence and phase-loss.

- Capable to distinguish between positive phases, reversed phases, and phase loss when unit is energized (K8DS-PH)
- Capable of detecting phase loss when motor is in operating condition
- SPDT relay (5 A @ 240 VAC, resistive loads)
- Output and relay status can be monitored using LED indicators
- K8AK-PH slim 22.5 mm width
- K8DS-PH slim 17.5 mm width



X

### Ordering Information

Description	Features	Rated Input Voltages	Relay Output	Mounting Dimensions	Model
3-Phase phase sequence, phase loss	Power Indicator, Relay Indicator	200 to 480 VAC	5 A @ 250 VAC (resistive load)	100 x 22.5 x 90 mm	K8AK-PH1
3-Phase phase sequence, phase loss	Power Indicator, Relay Indicator	200 to 480 VAC	5 A @ 250 VAC (resistive load)	100 x 17.5 x 90 mm	K8DS-PH1

## Space Saving, Ultra Slim 22.5 mm Temperature Monitoring Relays

Prevent equipment against damage from excessive temperature increases.

- Universal-input support for thermocouple and RTD sensors
- Set Value Protection - prohibits changes to set values of the temperature monitoring relay
- Wide range of functions: alarm mode (upper and lower limit), enable/disable latch, selectable temperature setting: degrees Fahrenheit or Celsius
- Simple rotary and DIP switch settings
- Alarm status identification with LED indicator



## Specifications

- Temperature sensor inputs:
  - K8AK-TH11S - Thermocouple Types K, J, T, E; Platinum RTD Pt100
  - K8AK-TH12S - Thermocouple Types K, J, T, E, B, R, S, PLII
- Relay capacity: 3 A @ 250 VAC or 30 VDC (resistive load)
- DIN track mounting
- Dimensions: 90 H x 22.5 W x 100 D mm

## Ordering Information

Description	Features	Relay Output	Model
Temperature range 0 to 999° C/F	Thermocouple/RTD inputs, 1° C/F setting unit	SPDT 3 A @ 250 VAC (resistive load)	K8AK-TH11S 100-240VAC
			K8AK-TH11S 24VAC/DC
Temperature Range 0 to 1800° C, 0 to 3200° F	Thermocouple/RTD inputs, 10° C/F setting unit		K8AK-TH12S 100-240VAC
			K8AK-TH12S 24VAC/DC



## Ultra-Slim 22.5 mm Liquid Level Controller

Protect equipment against damage from unforeseen spills and leaks.

- Reliable, floatless level control for automatic water supply and drainage in industrial facilities and equipment
- Adjustable sensitivity for conductive liquids ranging from distilled water, city water, well water, industrial water, sea water and sewage with specific resistance from 10 to 100 kΩ impedance
- Delay timer to prevent relay contact chatter from waves
- Relay status identification with LED indicator



- Relay capacity: 5 A @ 250 VAC or 30 VDC (resistive load)
- Timer setting: 0.1 to 10 s
- DIN track mounting
- Dimensions: 90 H x 22.5 W x 100 D mm

## Ordering Information-Floatless, Conductive Level Controller

Features	Input Voltage	Output	Model
3-electrode system for water supply or drainage control; order electrodes, holders and sockets separately. Adjustable operating resistance sensitivity.	24 VAC/VDC	SPDT 5 A @ 250 VAC/30 VDC	K8AK-LS 24VAC/DC
	100 to 240 VAC		K8AK-LS 100-240VAC

## Accessories-Electrode Rods

Application	Model
Purified water service, industrial water, and sewage	F03-60-SUS304
Purified water service, industrial water, sewage, and weak alkaline solutions	F03-60-SUS316

## Accessories-Electrode Holders, Covers, Separator

Application	Model
For 3 pole electrode (For general-purpose use such as water supply lines and purified water)	PS-3S
For 4 pole electrode (For general-purpose use such as water supply lines and purified water)	PS-4S
For 35 pole electrode (For general-purpose use such as water supply lines and purified water)	PS-5S
Areas with limited space	PS-31 SUS304 300 mm
Liquids with low resistance	BF-1
When mounting accuracy is required	BF-3/5
Resistance to high-temperature or high-pressure liquids	BS-1
Resistance against corrosion	BS-1T
Long distance installations from liquid	PH-1/2
Protective Cover (Electrode Holders for PS series)	F03-11
Mounting Piece (Electrode Holder for PS series)	F03-12
One Pole Separator	F03-14 1P
Three Pole Separator	F03-14 3P
Five Pole Separator	F03-14 5P

## Protect your Process Equipment from Liquid Spills and Leaks

- Detects liquid leaks by monitoring the resistance between conductive sensing bands
- Four selectable sensing ranges for liquids with impedance high as 50 MΩ
- Ideal for all grades of water, ammonia (NH<sub>3</sub>), hydrogen peroxide (H<sub>2</sub>O<sub>2</sub>), hydrochloric acid (HCl), phosphoric acid (H<sub>3</sub>PO<sub>4</sub>), fluorine (F) and isopropyl alcohol (IPA)
- Track-mount sockets and plug-in sensor amplifier simplify installation and maintenance



## Liquid Leakage Sensor

Description	Input signal	Output signal	Dimensions (mm)	Supply voltage	Model
Liquid Leakage Sensor Amplifier	0 to 50 MΩ impedance	NPN open collector, 100 mA at 30 VDC	28.8 H x 12.8 W x 46 D	24 VDC	K7L-AT50

## Sensing Bands

Description	Specification and appearance	Model
Sensing band, 1 m length	Sheath: polyethylene; Core: 316 stainless steel; 8 W x 1.7 H mm	F03-16PE-1M
Sensing band, 2 m length		F03-16PE-2M
Sensing band, 5 m length		F03-16PE-5M
Sensing band, 10 m length		F03-16PE-10M
Sensing band, 25 m length		F03-16PE-25M
Sensing band, 50 m length		F03-16PE-50M
Adhesive backed sensing band mounting bracket; 30 per pack	Material: Polyethylene; 13 L x 32 W x 3 H mm	F03-26PES
Screw mount sensing band bracket with two M3.5 dia. hole; 30 per pack	Material: Polyethylene; 13 L x 32 W x 3 H mm	F03-26PEN
Terminal block; 10 per pack	17 H x 29.1 W x 25 D mm Connects Sensing Band to Wiring Cable for sensor amplifier	F03-20
Socket with finger-protection	85.5 H x 16 W x 61 D mm Mounts sensor amplifier to DIN rail	P2RF-08-E
Socket	71.5 H x 19.5 W x 54 D mm Mounts sensor amplifier to DIN rail	P2RF-08

## Contents

### ELECTROMECHANICAL RELAYS

Selection Guide	Y-ii
-----------------	------

#### Industrial Plug-in Relays

G2RV	Ultra-slim industrial 6 A relay for PLC expansion	Y-1
G2R□-S	Slim general purpose 10 A plug-in relays	Y-2
MY	Multi-pole, long life general purpose relay	Y-3
LY	Plug-in general purpose relay with variable HP rating	Y-4
MKS	10 A octal base general purpose relay	Y-5
MJN	Flange mount plug-in general purpose relay	Y-6

#### DC Plug-in Relay

MKS-X	Maximum switching 10 A @ 220 VDC LED, two position test button	Y-7
-------	--	-----

#### Industrial High Power Relay

G7J	Heavy duty 25 A relay for switching for inductive load	Y-8
G7Z	Multi-pole 40 A relay with mirror contact for safety purposes	Y-9
MGN	Heavy-duty power relay switches 30 A loads	Y-10

### SOLID STATE RELAYS

Selection Guide	Y-viii
-----------------	--------

#### Panel Mounted

G3NE	Low profile, switching 20 A solid state relay	Y-11
G3NA	Hockey puck style solid state relay for up to 90 A load, 660 VAC available	Y-12

#### Built-in Heat Sink

G3PH	High power 150 A solid state relay, replaceable output cartridge	Y-13
G3PA	High power 60 A solid state relay for 1-3 phase load with easy connection	Y-14
G3PE	1-3 phase solid state relay, without heat sink type available (*3 phase type)	Y-15
G3PF	SSR with built-in CT and enable to detect heater burnout, SSR short-circuit	Y-16

#### Socket Mounted

G3RV	Ultra-slim industrial 3 A solid state relay for PLC expansion	Y-17
G3R-I/O	High-isolation solid state relay, Terminal comparable with G2R□-S	Y-18

#### PCB Mounted

G3MC	Ultra-slim compact 1-2 A PCB solid state relay	Y-19
G3TB	Color-coded PCB solid state relay with LED indicator	Y-20



## NONBENDABLE!

### G2RV-SL500 – Reduce wiring time by using push-in technology and cross bars

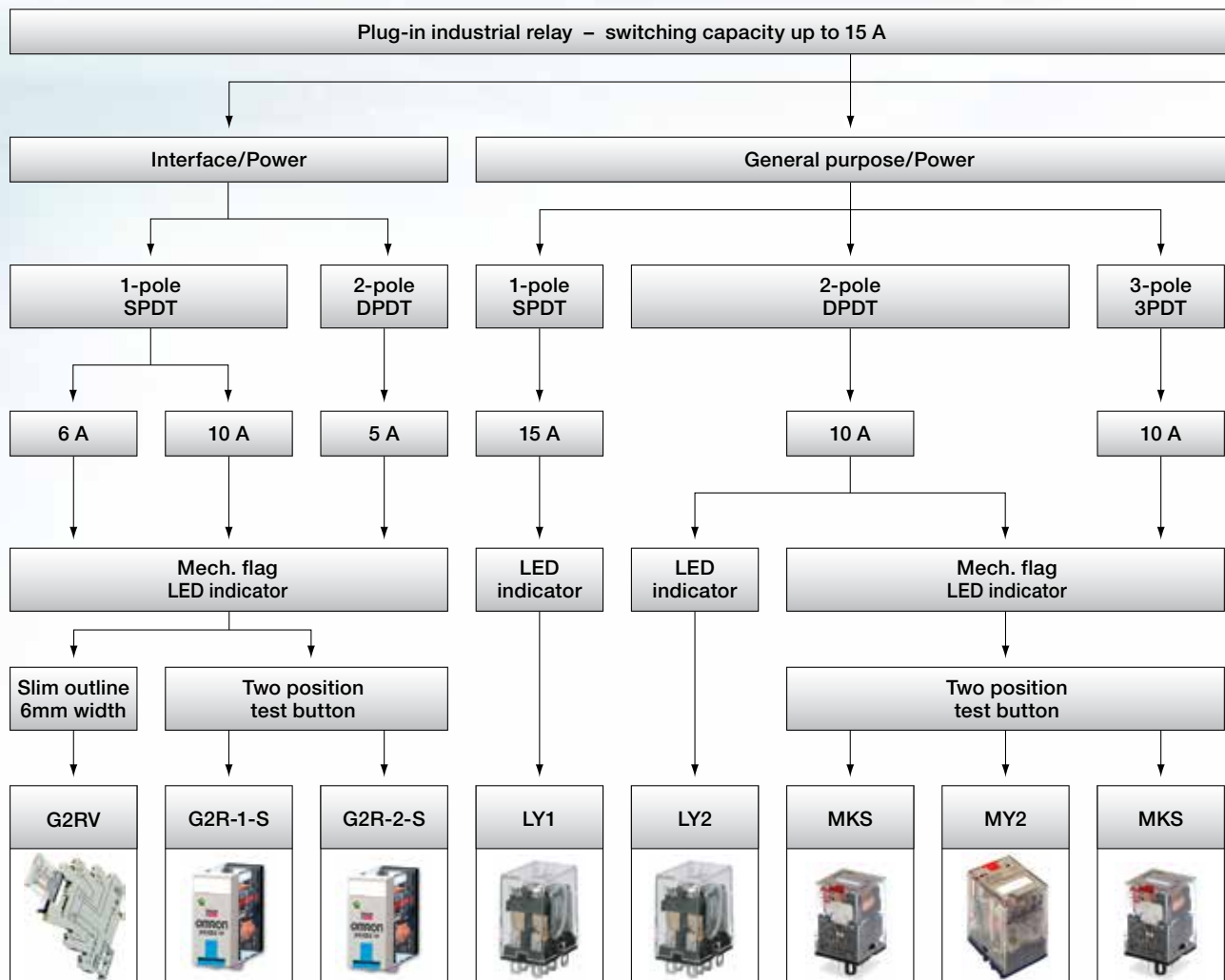

With the G2RV-SL500 series, only two steps are required to achieve a reliable connection between wire and terminal. Just remove the isolation and push in the wire. Cross bars make your life even easier, as they can be tailored by breaking pins away to meet your configuration requirements.

- No tools required
- Fits stranded wires (with ferrules) 0.5 - 2.5 mm<sup>2</sup>
- Fits solid wires 0.5 - 4.0 mm<sup>2</sup>

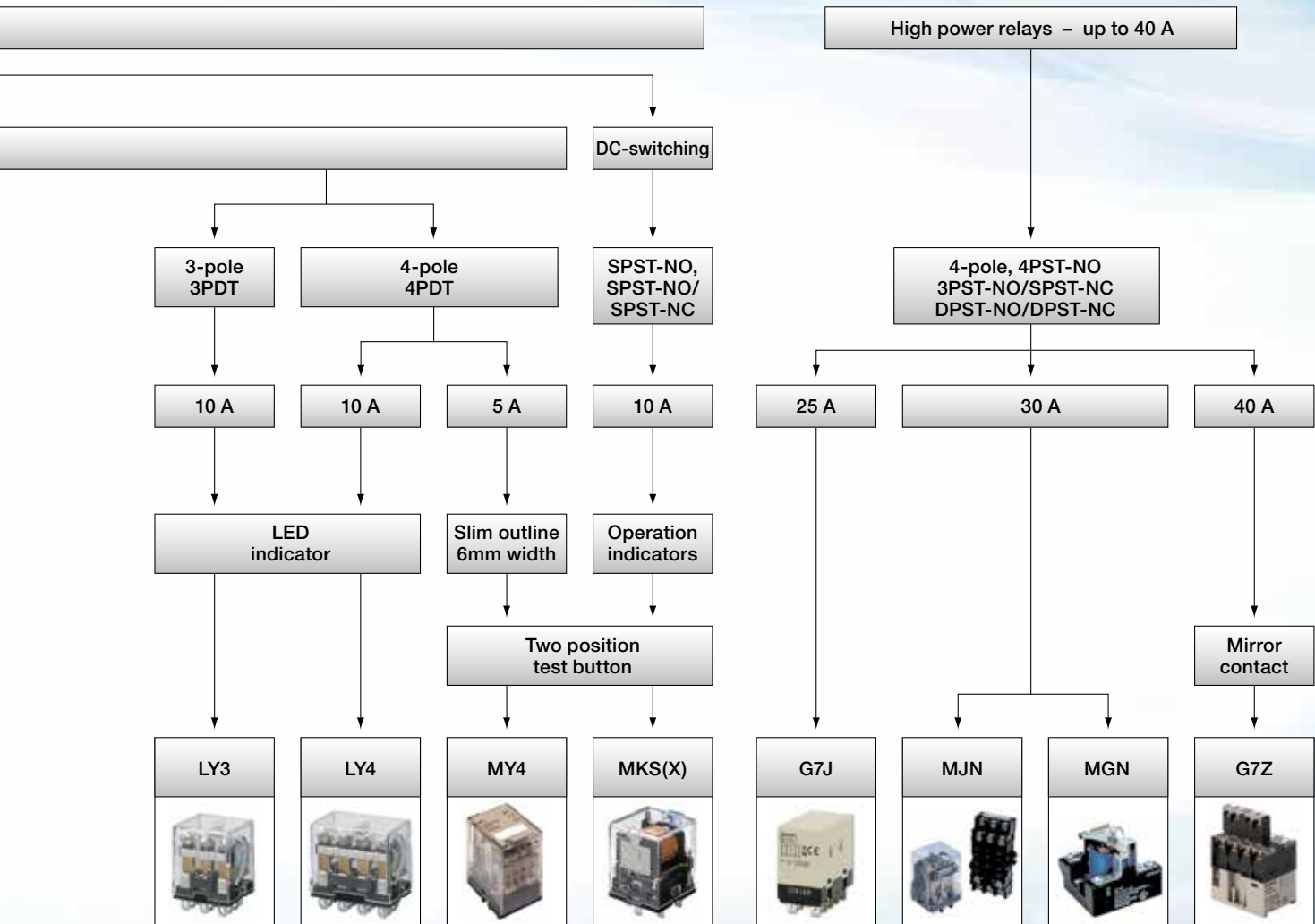
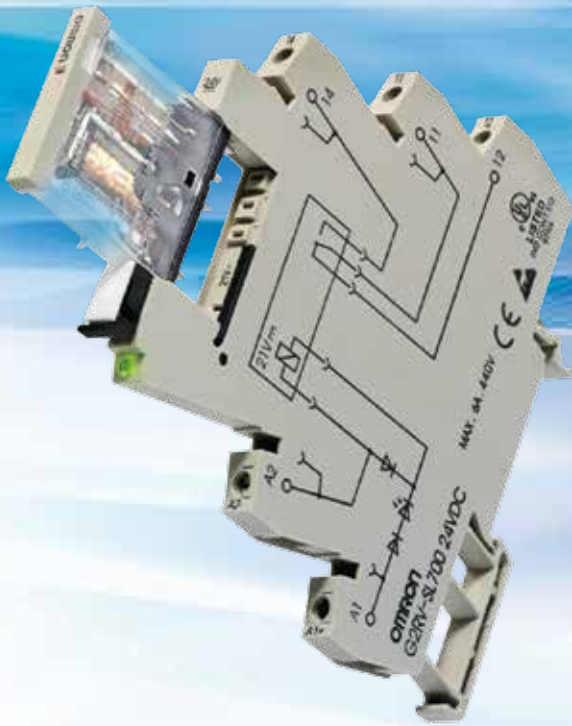





# Selection Table

Category		Interface/Power			General purpose/Power		
							
Selection criteria	Family	<b>G2RV</b>	<b>G2R□-S</b>		<b>MY</b>		
	1-pole	■	■	–	–	–	–
	2-pole	–	–	■	■	–	–
	3-pole	–	–	–	–	–	–
	4-pole	–	–	–	–	■	■
	Contact configuration	SPDT	SPDT	DPDT	DPDT	4PDT	4PDT bifurcated
	Max. switching current	6 A	10 A	5 A	10 A	5 A	5 A
	Min. switching current	1 mA at 100 VDC	100 mA at 5 VDC	10 mA at 5 VDC	1 mA at 5 VDC	1 mA at 1 VDC	0.1 mA at 1 VDC
	Gold clad/plate	□	–	□	–	■	■
	Width max. (Relay only)	6.2 mm	13.0 mm	13.0 mm	21.5 mm	21.5 mm	21.5 mm
Features	LED indication	■	□	□	□	□	□
	Mechanical flag	■	■	■	■	■	■
	Push-to-test button	–	–	–	–	–	–
	Two position test button	–	□	□	□	□	□
	Label	□	□	□	□	□	□
	Diode (DC coil)	■	□	□	□	□	□
	Varistor (AC coil)	–	–	–	–	–	–
	RC circuit (AC coil)	■	–	–	□	□	□
	Socket mounting	□	□	□	□	□	□
	Flange mounting	–	□	□	□	□	□
PCB mounting	–	□	□	□	□	□	
Wiring to socket	Screw	□	□	□	□	□	□
	Rise-up clamp	□	□	□	□	□	□
	Screw-less clamp	□	□	□	□	□	□

■ Standard    □ Available    – No/not available





# Electromechanical Relays

Category		General purpose/Power									
											
Selection criteria	Family	LY					MKS		MKS(X)		
	1-pole	■	–	–	–	–	–	–	■	–	
	2-pole	–	■	■	–	–	■	–	–	■	
	3-pole	–	–	–	■	–	–	■	–	–	
	4-pole	–	–	–	–	■	–	–	–	–	
	Contact configuration	SPDT	DPDT	DPDT bifurcated	3PDT	4PDT	DPDT	3PDT	SPST-NO	SPST-NO/SPST-NC	
	Max. switching current	15 A	10 A	7 A	10 A	10 A	10 A	10 A	10 A, 220 VDC; 15 A, 250 VAC	5 A, 220 VDC; 15 A, 250 VAC	
	Min. switching current	100 mA at 5 VDC	100 mA at 5 VDC	10 mA at 5 VDC	100 mA at 5 VDC	100 mA at 5 VDC	10 mA at 1 VDC	10 mA at 1 VDC	10 mA at 24 VDC	10 mA at 24 VDC	
	Gold clad/plate	–	–	■	–	–	–	–	–	–	
	Width max. (Relay only)	21.5 mm	21.5 mm	21.5 mm	31.5 mm	41.5 mm	34.5 mm	34.5 mm	34.5 mm	34.5 mm	
Features	LED indication	<input type="checkbox"/>	<input type="checkbox"/>	<input type="checkbox"/>	<input type="checkbox"/>	<input type="checkbox"/>	<input type="checkbox"/>	<input type="checkbox"/>	<input type="checkbox"/>	<input type="checkbox"/>	
	Mechanical flag	–	–	–	–	–	■	■	–	–	
	Push-to-test button	<input type="checkbox"/>	<input type="checkbox"/>	<input type="checkbox"/>	<input type="checkbox"/>	<input type="checkbox"/>	–	–	–	–	
	Two position test button	–	–	–	–	–	<input type="checkbox"/>	<input type="checkbox"/>	<input type="checkbox"/>	<input type="checkbox"/>	
	Label	–	–	–	–	–	<input type="checkbox"/>	<input type="checkbox"/>	–	–	
	Diode (DC coil)	<input type="checkbox"/>	<input type="checkbox"/>	<input type="checkbox"/>	<input type="checkbox"/>	<input type="checkbox"/>	<input type="checkbox"/>	<input type="checkbox"/>	<input type="checkbox"/>	<input type="checkbox"/>	
	Varistor (AC coil)	–	–	–	–	–	<input type="checkbox"/>	<input type="checkbox"/>	–	–	
	RC circuit (AC coil)	<input type="checkbox"/>	<input type="checkbox"/>	<input type="checkbox"/>	<input type="checkbox"/>	<input type="checkbox"/>	<input type="checkbox"/>	<input type="checkbox"/>	Optional for socket	Optional for socket	
	Socket mounting	<input type="checkbox"/>	<input type="checkbox"/>	<input type="checkbox"/>	<input type="checkbox"/>	<input type="checkbox"/>	<input type="checkbox"/>	<input type="checkbox"/>	<input type="checkbox"/>	<input type="checkbox"/>	
	Flange mounting	<input type="checkbox"/>	<input type="checkbox"/>	<input type="checkbox"/>	<input type="checkbox"/>	<input type="checkbox"/>	–	–	–	–	
	PCB mounting	<input type="checkbox"/>	<input type="checkbox"/>	<input type="checkbox"/>	<input type="checkbox"/>	<input type="checkbox"/>	–	–	–	–	
Wiring to socket	Screw	<input type="checkbox"/>	<input type="checkbox"/>	<input type="checkbox"/>	<input type="checkbox"/>	<input type="checkbox"/>	<input type="checkbox"/>	<input type="checkbox"/>	<input type="checkbox"/>	<input type="checkbox"/>	
	Rise-up clamp	–	–	–	–	–	<input type="checkbox"/>	<input type="checkbox"/>	–	–	
	Screw-less clamp	–	–	–	–	–	–	–	–	–	

■ Standard    □ Available    – No/not available



# Electromechanical Relays

Category		High power						General purpose/Power			High power		
													
Selection criteria	Family	G7J			G7Z			MJN			MGN		
	1-pole	–	–	–	–	–	–	■	–	–	■	–	–
	2-pole	–	–	–	–	–	–	–	■	–	–	■	■
	3-pole	–	–	–	–	–	–	–	–	■	–	–	–
	4-pole	■	■	■	■	■	■	SPDT	DPST DPDT	3PDT	SPST	DPST	DPDT
	Contact configuration	4PST-NO	3PST-NO/ SPST-NC	DPST-NO/ DPST-NC	4PST-NO	3PST-NO/ SPST-NC	DPST-NO/ DPST-NC	10 A	30 A	10 A	30 A	30 A	30 A
	Max. switching current	25 A	25 A	25 A	40 A	40 A	40 A	38.7 mm	38.7 mm	38.7 mm	63.5 mm	63.5 mm	84.3 mm
	Min. permissible load	100 mA at 24 VDC	100 mA at 24 VDC	100 mA at 24 VDC	2 A at 24 VDC	2 A at 24 VDC	2 A at 24 VDC	□	□	□	–	–	–
	Auxiliary contact block Mirror contact	–	–	–	■	■	■	–	–	–	–	–	–
	Momentary test button	–	–	–	–	–	–	□	□	□	–	–	–
Relay terminal	Screw	□	□	□	■	■	■	□	□	□	■	■	■
	Quick-connect	□	□	□	–	–	–	□	□	□	–	–	–
	PCB terminals	□	□	□	–	–	–	–	–	–	–	–	–
Mounting	Screw	–	–	–	■	■	■	–	–	–	■	■	■
	DIN rail	–	–	–	■	■	■	□	□	□	–	–	–
	Bracket (screw)	□	□	□	–	–	–	–	–	–	–	–	–
	Flange (screw)	–	–	–	–	–	–	□	□	□	–	–	–

■ Standard    □ Available    – No/not available



# Sockets & Accessories

Relay Type	DIN rail mount socket		Back connecting socket			
			Quick Connect/Solder Terminal		PCB Terminal	
	Socket	Hold down clip	Socket	Hold down clip	Socket	Hold down clip
G2R-1-S	P2RF-05 P2RF-05-E P2RF-05-S	— — P2CM-S	P2R-05A	—	P2R-057P P2R-05P	— —
G2R-2-S	P2RF-08 P2RF-08-E P2RF-08-S	— — P2CM-S	P2R-08A	—	P2R-057P P2R-08P	— —
LY1, LY2	PTF08A PTF08A-E	PYC-A1 *3 PYC-A1 *3	PT08	PYC-P *4	PT08-0	PYC-P *4
LY3	PTF11A	PYC-A1 *3	PT11	PYC-P *4	PT11-0	PYC-P *4
LY4	PTF14A PTF14A-E	PYC-A1 *3 PYC-A1 *3	PT14	PYC-P *4	PT14-0	PYC-P *4
MJN without mounting flange	PTF11PC	PYMJN-S	PTF11QDC	PYMJN-PCB	PTFPCB	PYMJN-PCB
MKK	PF113A	PFC-A1	PL11	PLC	PLE11-0	PLC-10
MKS2P	PF083A PF083A-E PF083A-D	PFC-A1 PFC-A1 —	—	—	—	—
MKS3P	PF113A PF113A-E PF113A-D	PFC-A1 PFC-A1 —	—	—	—	—
MKS(X)	P7MF-06 P7MF-06-D	PYC-A2 PYC-A2	—	—	P7M-06P	PYC-A2
MY2(S) without Latching lever	PYF08A-E PYF08A-N PYF08S	PYC-A1 PYC-A1 PYCM-08S	PY08 PY08-Y1	—	PY08-02	PYC-P or PYC-P2
MY2(S) with Latching lever	PYF08A-E PYF08A-N PYF08S	PYC-E1 PYC-E1 PYCM-08S	PY08	PYC-P2	PY08-02	PYC-P2
MY4(S)	PYF14A-E PYF14A-N PYF14S	PYC-A1 PYC-A1 PYCM-14S	PY14 PY14-Y1	PYC-P or PYC-P2 -	PY14-02	PYC-P or PYC-P2
MY2K	PYF14A-E	PYC-A1	PY14	PYC-P	PY14-02	PYC-P
MY4(Z)H	PYF14A-E	PYC-A1	—	—	—	—
MJN	PTF11PC PTF21PC	PYMJN-S	PTF11QDC	PYMNB-PCB	PTFPCB	PYMNB-PCB

- Note:
1. -E and -N models are finger-protect construction. Round terminals cannot be used. Use Y-shaped terminals.
  2. -S or S types are screwless terminal styles.
  3. RC circuit type need to use Y92H-3 hold down clips.
  4. Push button type need to use PYC-P2, RC circuit need to use PYC-1 hold down clips.

Relay Type	Mounting	Adaptor	Front connecting socket
	Bracket	Track Mount/Panel Mount	Track Mount/Panel Mount
G7J-(All)	R99-04-FOR-G5F	—	—

## VARIOUS KINDS OF SOLID STATE RELAYS

### G3□ series – Reliable interfacing and power switching

Omron offers Solid State Relays (SSRs) in a wide variety of output currents and voltages to handle frequently cycling loads. Control-panel mount types with built-in heat-sink (G3PE) and without (G3NA) are ideal for power switching. Compact SSRs for I/O Interfacing include ultra-slim G3RV and G3R.

- Industrial 6 mm 'slim' SSR which is G2RV compatible (G3RV)
- G2RS compatible high-speed interface solutions (G3R-I/O)
- G3NA with 5-90 A output current, G3PE up to 45 A
- Output voltages up to 660 VAC / 200 VDC available on G3NA
- Effectively absorbing of external surge thanks to the built-in varistor/surge pass circuit

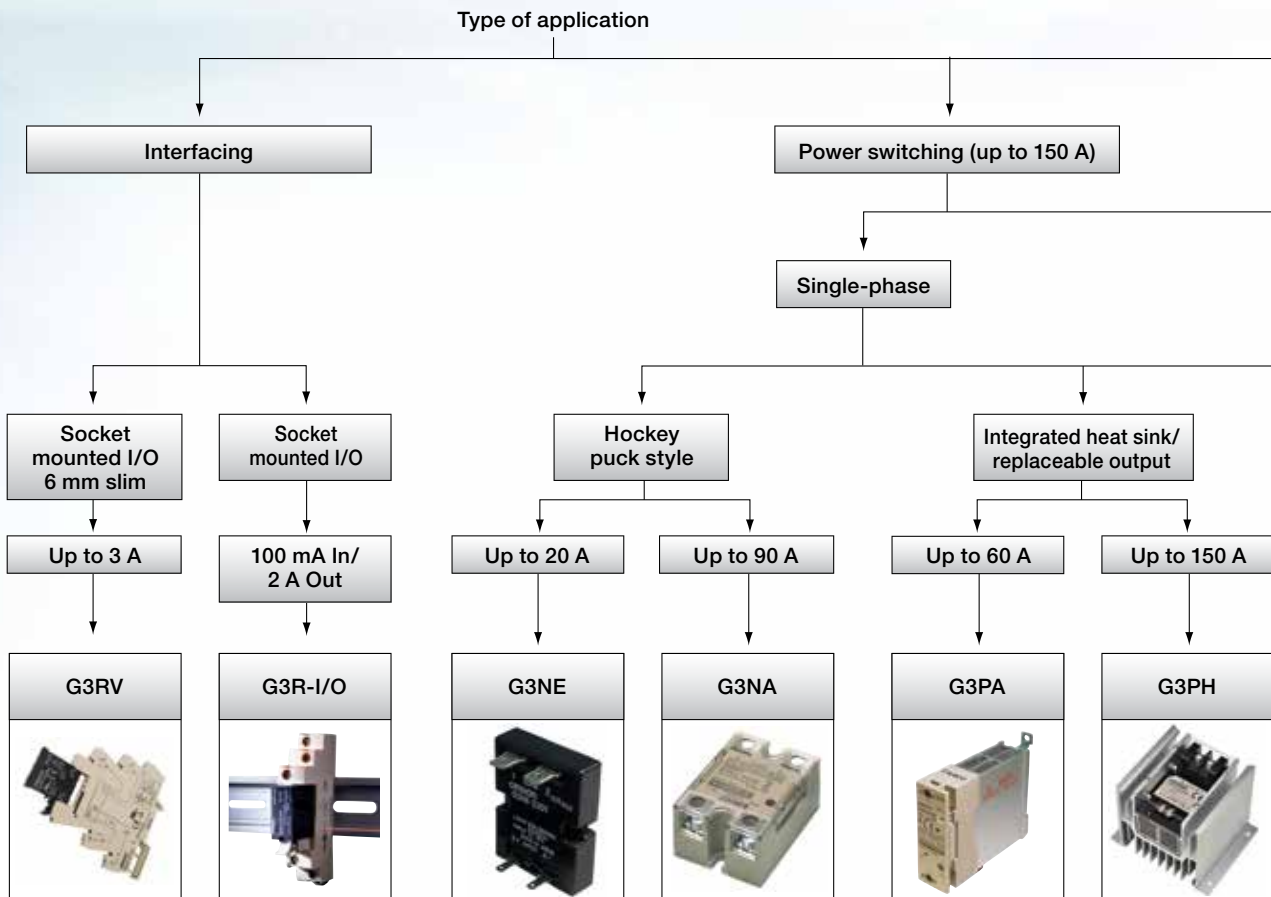

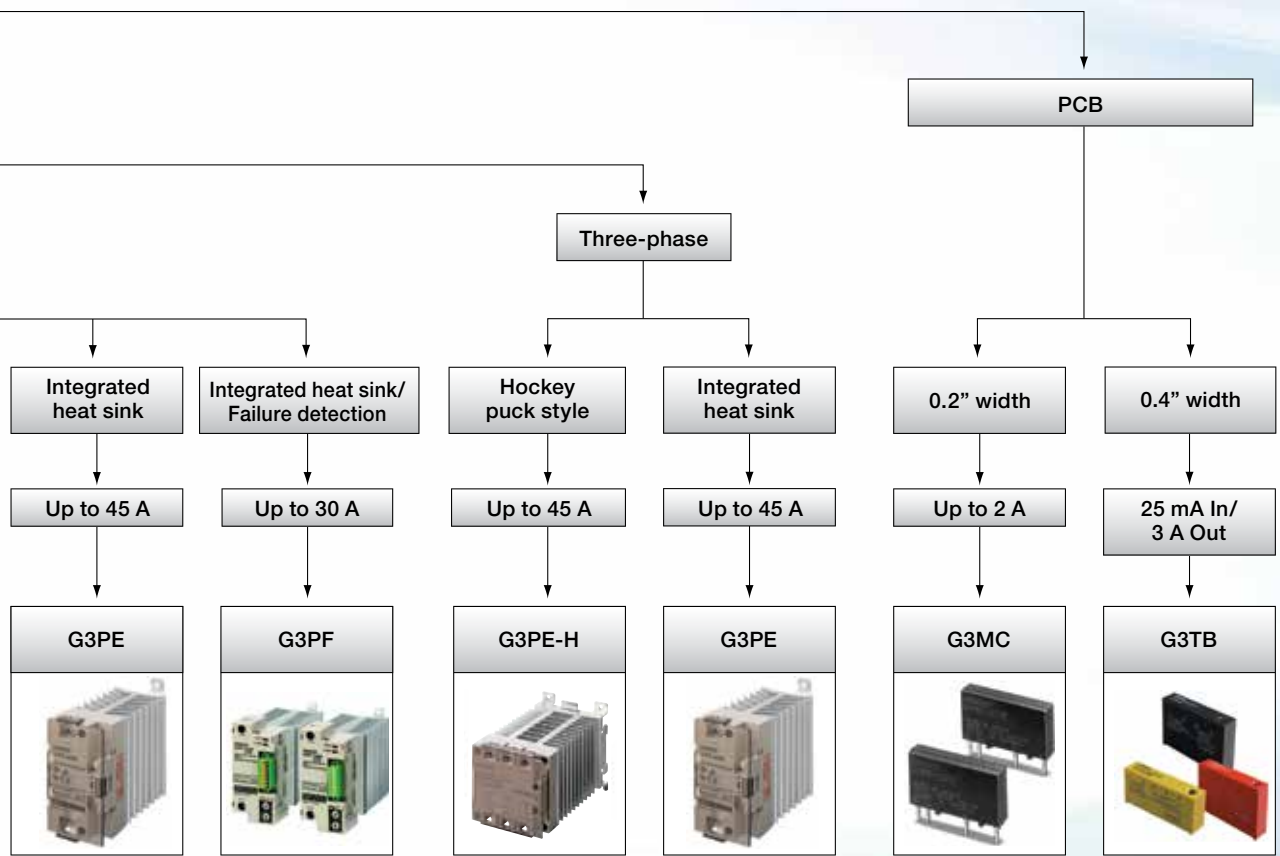





# Selection Table

Category		Socket mounted			Panel mounted	
						
Model		G3RV	G3R-I/O		G3NE	
			Input Module	Output Module		
Application	Signal Switching	■	■	□	–	
	Heater Control	□	–	□	■	
	Motor Control	□	–	□	■	
Load Voltage/ current Rating	A	Max. current rating	2 A (AC) 3 A (DC)	100 mA (DC)	2 A (AC, DC)	20 A (AC)
	VAC	200 V Range	75 to 264 V	–	75 to 264 V	75 to 264 V
		400 V Range	–	–	–	–
		600 V Range	–	–	–	–
VDC	DC Output Range	3 to 26.4	4 to 32 V	4 to 60 V 40 to 200 V	–	
Input Voltage	DC	■	■	■	■	
	AC	■	■	–	–	
Features	Built-in Heat Sink	–	–	–	–	
	Zero-cross Circuit	□	–	□	□	
	Built-in Varistor	–	–	–	■	
	LED Indicator	■	■	■	–	
	Protective Cover	–	–	–	–	
Mounting	DIN-Rail	■	–	–	□	
	Panel	–	–	–	■	
	Socket (DIN, Panel)	■	■	■	■	
	PCB	N/A	N/A	N/A	■	
Safety Standards	UL Recognized	■	■	■	■	
	UL Listed	■	–	–	–	
	CSA	■	■	■	■	
	CE	■	■	■	■	
	TÜV	■	■	■	■	
	VDE	–	–	–	–	



■ Standard    □ Available    – No/not available

# Solid State Relays

Category		Panel mounted					
							
Model		G3NA	G3PA	G3PH	G3PE		
					1-phase	3-phase	
Application	Signal Switching	–	–	–	–	–	
	Heater Control	■	■	■	■	■	
	Motor Control	■	□	–	–	–	
Load Voltage/ current Rating	A	Max. current rating 90 A (AC) 10 A (DC)	60 A (AC)	150 A (AC)	45 A (AC)	45 A (AC)	
	VAC	200 V Range	19 to 264 V	19 to 264 V	75 to 264 V	75 to 264 V	75 to 264 V
		400 V Range	180 to 528 V	150 to 440 V 180 to 528 V	180 to 528 V	180 to 528 V	180 to 528 V
		600 V Range	360 to 660 V	–	–	–	–
VDC	DC Output Range	4 to 220 V	–	–	–	–	
Input Voltage	DC	–	■	■	■	■	
	AC	■	□ by using G32A-B	□ by using G32A-B	□ by using G32A-B	□ by using G32A-B	
Features	Built-in Heat Sink	–	■	■	■	■	
	Zero-cross Circuit	■	□	□	□	■	
	Built-in Varistor	■	■	■	■	■	
	LED Indicator	■	■	■	■	■	
	Protective Cover	■	■	■	■	■	
	Replaceable Power Cartridge	–	■	■	–	–	
Mounting	DIN-Rail	□	■	–	■	□	
	Panel	■	■	■	■	■	
	Socket (DIN, Panel)	–	–	–	–	–	
	PCB	–	–	–	–	–	
Safety Standards	UL Recognized	■	■	cULus	■	■	
	UL Listed	–	–	–	–	–	
	CSA	■	■	cULus	■	■	
	CE	■	■	■	■	■	
	TÜV	■	–	■	■	■	
	VDE	–	■	–	–	–	

■ Standard    □ Available    – No/not available

# Selection Table

Category		Panel mounted	PCB mounted			
						
Model		G3PF	G3MC	G3TB		
				Input Module	Output Module	
Application	Signal Switching	–	□	■	□	
	Heater Control	■	□	–	□	
	Motor Control	–	□	–	□	
Load Voltage/ current Rating	A	Max. current rating	35 A (AC)	2 A (AC)	25 mA	3 A (AC)
	VAC	200 V Range	75 to 264 V	75 to 132 V 75 to 264 V	–	75 to 264 V
		400 V Range	180 to 528 V	–	–	–
		600 V Range	–	–	–	–
VDC	DC Output Range	–	–	4 to 32 V	4 to 60 V 40 to 200 V	
Input Voltage	DC	■	■	■	■	
	AC	□ by using G32A-B	–	■	–	
Features	Built-in Heat Sink	■	–	–	–	
	Zero-cross Circuit	■	■	□	□	
	Non-Zero-cross Circuit	–	■	□	□	
	Built-in Varistor	■	–	–	–	
	LED Indicator	■	–	■	□	
	Protective Cover	■	–	–	–	
	Alarm Output	■	–	–	–	
	Built-in Failure Detection	■	–	–	–	
	SSR Open Circuits Detection	■	–	–	–	
	SSR Short Circuit Detections	■	–	–	–	
Mounting	DIN-Rail	■	–	–	–	
	Panel	■	–	–	–	
	Socket (DIN, Panel)	–	–	–	–	
	PCB	–	■	■	■	
Safety Standards	UL Recognized	□	■	■	■	
	UL Listed	–	–	–	–	
	CSA	■	■	■	■	
	CE	■	–	–	–	
	TÜV	■	–	–	–	
	VDE	–	■	–	–	

■ Standard    □ Available    – No/not available

## General Purpose Plug-in Ultra Slim Relay Switching 6 A @ 250 VAC

The G2RV is an ultra-slim 6 mm wide DIN mount relay-socket unit with maintenance friendly features.

- Mechanical indicator and socket LED provide quick verification relay is functioning
- Large terminal-receptacle area: 20 to 14 AWG
- Electrical Life of 100K Cycles lasting performance
- Interface and cable accessories allow PLC control of G2RV Relays
- Cross (Bus) bars provide a quick and easy way to connect multiple G2RV Relays together
- RoHS Compliant; Relay-Socket models cULus Listed; VDE, CE, and cULus approved



- For PLC input control use gold plated contact versions with suffix "-AP"

## Ordering Information

Rated resistive load	Contact form	Socket terminals	LED indicator on socket	Coil voltage	Model
6 A @ 250 VAC	SPDT	Push-in	Yes	110 VAC	G2RV-SL500 AC110
				24 VDC	G2RV-SL500 DC24(DC21)
6 A @ 250 VAC	SPDT	Screw	Yes	24 VAC/24 VDC	G2RV-SL700 AC/DC24
				110 VAC	G2RV-SL700 AC110
				230 VAC	G2RV-SL700 AC230
				12 VDC	G2RV-SL700 DC12(DC11)
				24 VDC	G2RV-SL700 DC24(DC21)

Note: Model number contains relay and socket.

## G2RV with Mechanical Flag

Standard Type with test switch					
Rated resistive load	Contact form	Socket terminals	LED indicator on socket	Coil voltage	Model
6 A	SPDT	Screw	Yes	24 VDC	G2RV-SL701 24 VDC
				24 VAC/VDC	G2RV-SL701 24 VAC/VDC
		Push-in		24 VDC	G2RV-SL501 24 VDC
				24 VAC/VDC	G2RV-SL501 24 VAC/VDC
Standard Type with gold plating contacts					
50mA	SPDT	Screw	Yes	12 VDC	G2RV-SL700-AP DC12
				24 VDC	G2RV-SL700-AP DC24
				24 VAC/VDC	G2RV-SL700-AP AC/DC24
				48 VAC/VDC	G2RV-SL700-AP AC/DC48
				110 VAC	G2RV-SL700-AP AC110
				230 VAC	G2RV-SL700-AP AC230
		Push-in		12 VDC	G2RV-SL500-AP DC12
				24 VDC	G2RV-SL500-AP DC24
				24 VAC/VDC	G2RV-SL500-AP AC/DC24
				48 VAC/VDC	G2RV-SL500-AP AC/DC48
				110 VAC	G2RV-SL500-AP AC110
				230 VAC	G2RV-SL500-AP AC230

## G2RV Input Modules with Slide Switch

Rated resistive load	Contact form	Socket terminals	LED indicator on socket	Coil voltage	Model
6 A @ 250 VAC	SPDT	Push-in	Yes	12 VDC	G2RV-SL500-AP DC12
				24 VDC	G2RV-SL500-AP DC24
				24 VAC/VDC	G2RV-SL500-APAC/DC24
				48 VAC/VDC	G2RV-SL500-AP AC/DC48
				110 VAC	G2RV-SL500-AP AC110
				230 VAC	G2RV-SL500-AP AC230
6 A @ 250 VAC	SPDT	Screw	Yes	12 VDC	G2RV-SL700-AP DC12
				24 VDC	G2RV-SL700-AP DC24
				24 VAC/VDC	G2RV-SL700-APAC/DC24
				48 VAC/VDC	G2RV-SL700-AP AC/DC48
				110 VAC	G2RV-SL700-AP AC110
				230 VAC	G2RV-SL700-AP AC230

## Slim and Space-saving Plug-in Relay

The G2R□-S is a maintenance-friendly 5 A - 10 A 1/2 inch wide general purpose relay.

- Mechanical indicator comes standard allowing user to verify contact operation
- Space saving 16 mm wide DIN mount socket
- Finger safe G2R□-S socket
- Energy efficient DC coil (530 mW consumption)
- RoHS Compliant; UL, CSA, CE, and VDE Approved



## Ordering Information

Rated resistive load	Contact form	Terminal type	LED indicator	Diode	Two position test button	Coil voltage	Model
10 A @ 250 VAC	SPDT	Plug-in	No	No	No	120 VAC	G2R-1-S AC120 (S)
10 A @ 250 VAC	SPDT	Plug-in	No	No	No	24 VDC	G2R-1-S DC24 (S)
10 A @ 250 VAC	SPDT	Plug-in	Yes	No	No	120 VAC	G2R-1-SN AC120 (S)
10 A @ 250 VAC	SPDT	Plug-in	Yes	Yes	No	24 VDC	G2R-1-SND DC24 (S)
10 A @ 250 VAC	SPDT	Plug-in	Yes	Yes	Yes	24 VDC	G2R-1-SNDI DC24 (S)
5 A @ 250 VAC	DPDT	Plug-in	No	No	No	24 VDC	G2R-2-S DC24 (S)
5 A @ 250 VAC	DPDT	Plug-in	Yes	No	No	120 VAC	G2R-2-SN AC120 (S)
5 A @ 250 VAC	DPDT	Plug-in	Yes	Yes	No	24 VDC	G2R-2-SND DC24 (S)
5 A @ 250 VAC	DPDT	Plug-in	Yes	Yes	Yes	24 VDC	G2R-2-SNDI DC24 (S)
5 A @ 250 VAC	DPDT	Plug-in	Yes	No	Yes	120 VAC	G2R-2-SNI AC120 (S)

Note: Corresponding sockets can be found on page Y-vii.



## Miniature General Purpose Relay

The MY is a multi-pole long life general purpose relay ideal for various applications.

- DPDT models: 500K electrical life cycles; 4PDT models: 200K (100K bifurcated) at Rated Load
- MY2K Latching relays: Great option for reduced energy consumption
- MY4Z bifurcated models can switch loads under 1 mA at 1 VDC; great for PLC Control
- RoHS Compliant; UL, CSA, CE, VDE, SEV, IMQ and Lloyd Approved



## Ordering Information

### MY

Quick Link **R223** omron247.com

Factory rated resistive load	Contact Form	Mounting Style	Bifurcated model	LED indicator	LED indicator/Lockable test button	Diode	Coil voltage	Model
5 A @ 250 VAC	DPDT	Socket	No	Yes	No	No	24 VDC	MY2N DC24(S)
5 A @ 250 VAC	DPDT	Socket	No	Yes	No	No	24 VAC	MY2N AC24(S)
5 A @ 250 VAC	DPDT	Socket	No	Yes	No	No	110/120 VAC	MY2N AC110/120(S)
5 A @ 250 VAC	DPDT	Socket	No	Yes	No	No	220/240 VAC	MY2N AC220/240(S)
5 A @ 250 VAC	DPDT	Socket	No	No	Yes	Yes	24 VDC	MY2N-D2 DC24(S)
5 A @ 250 VAC	DPDT	Socket	No	No	Yes	No	12 VDC	MY2IN DC12(S)
5 A @ 250 VAC	DPDT	Socket	No	No	Yes	No	24 VDC	MY2IN DC24(S)
5 A @ 250 VAC	DPDT	Socket	No	No	Yes	No	24 VAC	MY2IN AC24(S)
5 A @ 250 VAC	DPDT	Socket	No	No	Yes	No	110/120 VAC	MY2IN AC110/120(S)
5 A @ 250 VAC	DPDT	Socket	No	No	Yes	No	110/120 VAC	MY2IN AC220/240(S)
3 A @ 250 VAC	4PDT	Socket	No	Yes	No	No	24 VAC	MY4N AC24(S)
3 A @ 250 VAC	4PDT	Socket	No	Yes	No	No	110/120 VAC	MY4N AC110/120(S)
3 A @ 250 VAC	4PDT	Socket	No	No	Yes	No	12 VDC	MY4N DC12(S)
3 A @ 250 VAC	4PDT	Socket	No	No	Yes	No	24 VAC	MY4IN AC24(S)
3 A @ 250 VAC	4PDT	Socket	No	No	Yes	No	24 VDC	MY4IN DC24(S)
3 A @ 250 VAC	4PDT	Socket	No	No	Yes	No	110/120 VAC	MY4IN AC110/120(S)
3 A @ 250 VAC	4PDT	Socket	No	No	Yes	No	110/120 VAC	MY4IN AC220/240(S)
3 A @ 250 VAC	4PDT	Socket	No	Yes	No	No	24 VDC	MY4N-D2 DC24(S)
3 A @ 250 VAC	4PDT	Socket	Yes	Yes	Yes	No	24 VDC	MY4ZIN DC24(S)
3 A @ 250 VAC	4PDT	Socket	Yes	Yes	No	No	110/120 VAC	MY4ZIN AC110/120(S)
3 A @ 250 VAC	4PDT	PCB	No	No	No	No	12 VDC	MY4-02 DC12

Note: Corresponding sockets can be found on page Y-vii.

### MYK

Quick Link **R238** omron247.com

Factory rated resistive load	Contact form	Terminal type	Bifurcated model	Two position test button	LED indicator	Diode	Coil voltage	Model
3 A @ 250 VAC	DPDT	Plug-in	No	No	No	No	120 VAC	MY2K-US AC120*

\*This model is a latching relay.

## Long Life General Purpose Relay with HP Rating Ideal for HVAC and Appliance Market

The LY is a reliable multi-pole general purpose relay with Plug-in, Quick Connect and PCB Terminals.

- 500K electrical life DPDT models; 200K for SPDT, 3PDT, and 4PDT models at rated load
- HP rating ideal for Appliances and HVAC Systems
- RoHS Compliant; CE, UL, CSA, SEV, VDE and TÜV Approved



### Ordering Information

Rated resistive	Contact form	Mounting Style	UL horsepower	LED indicator	Diode	Coil voltage	Model
15 A @ 110 VAC	SPDT	Socket	0.5 HP @120 VAC	No	No	12 VDC	LY1 DC12
15 A @ 110 VAC	SPDT	Socket	0.5 HP @120 VAC	No	No	24 VDC	LY1 DC24
15 A @ 110 VAC	SPDT	Socket	0.5 HP @120 VAC	No	No	24 VAC	LY1 AC24
15 A @ 110 VAC	SPDT	Socket	0.5 HP @120 VAC	No	No	110/120 VAC	LY1 AC110/120
15 A @ 110 VAC	SPDT	Flange	0.5 HP @120 VAC	No	No	24 VDC	LY1F DC24
10 A @ 110 VAC	DPDT	Socket	0.5 HP @120 VAC	No	No	12 VDC	LY2 DC12
10 A @ 110 VAC	DPDT	Socket	0.5 HP @120 VAC	No	No	24 VDC	LY2 DC24
10 A @ 110 VAC	DPDT	Socket	0.5 HP @120 VAC	No	No	24 VAC	LY2 AC24
10 A @ 110 VAC	DPDT	Socket	0.5 HP @120 VAC	No	No	110/120 VAC	LY2 AC110/120
10 A @ 110 VAC	DPDT	Socket	0.5 HP @120 VAC	Yes	Yes	110/120 VAC	LY2N AC110/120
10 A @ 110 VAC	DPDT	PCB	0.5 HP @120 VAC	No	No	12 VDC	LY2-0 DC12
10 A @ 110 VAC	DPDT	Socket	0.5 HP @120 VAC	No	No	110/120 VAC	LY2-0 AC110/120
10 A @ 110 VAC	3PDT	Socket	0.5 HP @ 240 VAC	No	No	12 VDC	LY3 DC12
10 A @ 110 VAC	3PDT	Socket	0.5 HP @ 240 VAC	No	No	24 VDC	LY3 DC24
10 A @ 110 VAC	3PDT	Socket	0.5 HP @ 240 VAC	No	No	24 VAC	LY3 AC24
10 A @ 110 VAC	3PDT	Socket	0.5 HP @ 240 VAC	No	No	110/120 VAC	LY3 AC110/120
10 A @ 110 VAC	4PDT	Socket	0.5 HP @ 240 VAC	No	No	12 VDC	LY4 DC12
10 A @ 110 VAC	4PDT	Socket	0.5 HP @ 240 VAC	No	No	24 VDC	LY4 DC24
10 A @ 110 VAC	4PDT	Socket	0.5 HP @ 240 VAC	No	No	24 VAC	LY4 AC24
10 A @ 110 VAC	4PDT	Socket	0.5 HP @ 240 VAC	No	No	110/120 VAC	LY4 AC110/120

Note: Corresponding sockets can be found on page Y-vii.

## General Purpose Relay with Octal Base, Latching Test Button

Two- and three-pole socket mount relays with UL Rated 10 A resistive Load @ 250 VAC/ 30 VDC, and 100K cycles.

- Mechanical indicator comes standard, allowing user to verify contact operation
- Manual and latched position testing possible when using MKS Test Button Models
- LED indicator models come with white name plate ideal for marking key notes
- RoHS Compliant; cULus Recognized; CE, and TÜV Approved



- Various internal connection for MRO purpose: Standard type (-5), non-Standard type (-2 or blank)

## Ordering Information

Rated resistive Load (NO Contact)	Contact Form	Mounting Style	Mechanical indicator	Mechanical indicator/LED indicator	Mechanical indicator/LED indicator/Push-to-test button	Coil voltage	Model
10 A @ 250 VAC/30 VDC	DPDT	Socket	Yes	No	No	12 VDC	MKS2P DC12
10 A @ 250 VAC/30 VDC	DPDT	Socket	Yes	No	No	24 VDC	MKS2P DC24
10 A @ 250 VAC/30 VDC	DPDT	Socket	Yes	No	No	24 VAC	MKS2P AC24
10 A @ 250 VAC/30 VDC	DPDT	Socket	Yes	No	No	120 VAC	MKS2P AC120
10 A @ 250 VAC/30 VDC	DPDT	Socket	No	Yes	No	12 VDC	MKS2PN DC12
10 A @ 250 VAC/30 VDC	DPDT	Socket	No	Yes	No	24 VDC	MKS2PN DC24
10 A @ 250 VAC/30 VDC	DPDT	Socket	No	Yes	No	24 VAC	MKS2PN AC24
10 A @ 250 VAC/30 VDC	DPDT	Socket	No	Yes	No	120 VAC	MKS2PN AC120
10 A @ 250 VAC/30 VDC	DPDT	Socket	No	No	Yes	12 VDC	MKS2PIN DC12
10 A @ 250 VAC/30 VDC	DPDT	Socket	No	No	Yes	24 VDC	MKS2PIN DC24
10 A @ 250 VAC/30 VDC	DPDT	Socket	No	No	Yes	24 VAC	MKS2PIN AC24
10 A @ 250 VAC/30 VDC	DPDT	Socket	No	No	Yes	120 VAC	MKS2PIN AC120
10 A @ 250 VAC/30 VDC	3PDT	Socket	Yes	No	No	12 VDC	MKS3P-5 DC12
10 A @ 250 VAC/30 VDC	3PDT	Socket	Yes	No	No	24 VDC	MKS3P-5 DC24
10 A @ 250 VAC/30 VDC	3PDT	Socket	Yes	No	No	24 VAC	MKS3P-5 AC24
10 A @ 250 VAC/30 VDC	3PDT	Socket	Yes	No	No	120 VAC	MKS3P-5 AC120
10 A @ 250 VAC/30 VDC	3PDT	Socket	No	Yes	No	12 VDC	MKS3PI-5 DC12
10 A @ 250 VAC/30 VDC	3PDT	Socket	No	Yes	No	24 VDC	MKS3PI-5 DC24
10 A @ 250 VAC/30 VDC	3PDT	Socket	No	Yes	No	24 VAC	MKS3PI-5 AC24
10 A @ 250 VAC/30 VDC	3PDT	Socket	No	Yes	No	120 VAC	MKS3PI-5 AC120
10 A @ 250 VAC/30 VDC	3PDT	Socket	No	No	Yes	12 VDC	MKS3PIN-5 DC12
10 A @ 250 VAC/30 VDC	3PDT	Socket	No	No	Yes	24 VDC	MKS3PIN-5 DC24
10 A @ 250 VAC/30 VDC	3PDT	Socket	No	No	Yes	24 VAC	MKS3PIN-5 AC24
10 A @ 250 VAC/30 VDC	3PDT	Socket	No	No	Yes	120 VAC	MKS3PIN-5 AC120

Note: Corresponding sockets can be found on page Y-vii.

## Multi-Pole 10-30 A General Purpose Relay with 600 VAC Maximum Switching Voltage

The MJN is an SPDT, DPDT, and 3PDT general purpose relay ideal for motor applications.

- UL and CSA Recognized as motor controllers up to 600 VAC
- 10 A models have UL 1/3 HP @ 120 VAC
- Rugged power divider offers 3/16" clearance and 3/8" creepage
- MJN models have max. 15 A @ 600 VAC load rating
- MJN capable of switching 277 VAC loads
- 10 A DPDT latching models available; a good option for reducing power consumption.



## Ordering Information

Rated resistive Load (NO Contact)	Contact Form	Mounting Style	Latching Model	LED indicator	Test Button	Coil Voltage	Model
10 A @ 240 VAC/28 VDC	SPDT	Socket	No	No	No	12 VDC	MJN1C DC12
10 A @ 240 VAC/28 VDC	SPDT	Socket	No	No	No	24 VDC	MJN1C DC24
10 A @ 240 VAC/28 VDC	SPDT	Socket	No	No	No	24 VAC	MJN1C AC24
10 A @ 240 VAC/28 VDC	SPDT	Socket	No	No	No	120 VAC	MJN1C AC120
10 A @ 240 VAC/28 VDC	SPDT	Flange	No	No	No	12 VDC	MJN1CF DC12
30 A @ 28 VDC	SPDT	Flange	No	No	No	120 VAC	MJN1Z-E-RP AC120
10 A @ 240 VAC/28 VDC	DPDT	Socket	No	No	No	12 VDC	MJN2C DC12
10 A @ 240 VAC/28 VDC	DPDT	Socket	No	No	No	24 VDC	MJN2C DC24
10 A @ 240 VAC/28 VDC	DPDT	Socket	No	No	No	24 VAC	MJN2C AC24
10 A @ 240 VAC/28 VDC	DPDT	Socket	No	No	No	120 VAC	MJN2C AC120
10 A @ 240 VAC/28 VDC	DPDT	Socket	No	No	No	110 VDC	MJN2C DC110
20 A @ 277 VAC/28 VDC	DPDT	Flange	No	No	No	120 VAC	MJN2C-E AC120
10 A @ 240 VAC/28 VDC	DPDT	Flange	No	No	No	24 VAC	MJN2CF AC24
10 A @ 240 VAC/28 VDC	DPDT	Flange	Yes	No	No	120 VAC	MJN2CK AC120
10 A @ 240 VAC/28 VDC	3PDT	Socket	No	No	No	12 VDC	MJN3C DC12
10 A @ 240 VAC/28 VDC	3PDT	Socket	No	No	No	24 VDC	MJN3C DC24
10 A @ 240 VAC/28 VDC	3PDT	Socket	No	No	No	24 VAC	MJN3C AC24
10 A @ 240 VAC/28 VDC	3PDT	Socket	No	No	No	120 VAC	MJN3C AC120
10 A @ 240 VAC/28 VDC	3PDT	Socket	No	Yes	Yes	120 VAC	MJN3C-IN AC120
10 A @ 240 VAC/28 VDC	3PDT	Socket	No	Yes	No	24 VDC	MJN3C-N DC24
10 A @ 240 VAC/28 VDC	3PDT	Socket	No	Yes	No	110 VDC	MJN3C-N DC110

Note: Corresponding sockets can be found on page Y-vii.

## Plug-in Relay with High Switching Capacity (10 A@ 220 VDC)

- MKS-X Socket Mount Relays are at least 4 mm shorter versus main competitors
- Manual and latched position testing possible when using MKS-X Test Button Models
- Wide range of coil voltages available
- RoHS Compliant; cULus Recognized; CE, and TÜV Approved



## Ordering Information

Rated resistive load (NO Contact)	Contact form	Terminal type	Two position test button	LED indicator	Coil voltage	Model
15 A @ 250 VAC	SPST-NO	Plug-In	Yes	Yes	120 VAC	MKS1TIN-10 AC120
10 A @ 220 VDC	SPST-NO	Plug-In	No	No	240 VAC	MKS1XT-10 AC240
10 A @ 220 VDC	SPST-NO	Plug-In	No	No	24 VDC	MKS1XT-10 DC24
10 A @ 220 VDC	SPST-NO	Plug-In	Yes	No	120 VAC	MKS1XTI-10 AC120
10 A @ 220 VDC	SPST-NO	Plug-In	Yes	No	24 VDC	MKS1XTI-10 DC24
10 A @ 220 VDC	SPST-NO	Plug-In	Yes	Yes	24 VDC	MKS1XTIN-10 DC24
10 A @ 220 VDC	SPST-NO	Plug-In	No	Yes	24 VDC	MKS1XTN-10 AC24
5 A @ 220 VDC	SPST-NO + SPST-NC	Plug-In	No	No	24 VDC	MKS2XT-11 DC24
5 A @ 220 VDC	SPST-NO + SPST-NC	Plug-In	Yes	Yes	120 VAC	MKS2XTIN-11 AC120

Note: Corresponding sockets can be found on page Y-vii.

## Multi-Pole Relay for Heavy Duty Load

The G7J is a multi-pole relay ideal for switching motors, compressors, and pump controls.

- UL 3 HP @ 277 VAC (NO contact)
- UL 3-phase rating of 5 HP @ 277 VAC
- UL general use rating of 25 A @ 240 VAC
- UL 1.5 kW @ 120 VAC Tungsten Rating (NO contact)
- RoHS Compliant; UL, CSA, CE and VDE Approved



## Ordering Information

Rated resistive load (NO Contact)	Contact form	Terminal type	Coil voltage	Model
25 A @ 220 VAC	DPST-NO, DPST-NC	Screw	200/240 VAC	G7J-2A2B-B-W1 AC200/240
25 A @ 220 VAC	DPST-NO, DPST-NC	Screw	24 VDC	G7J-2A2B-B-W1 DC24
25 A @ 220 VAC	DPST-NO, DPST-NC	Quick-Connect	100/120 VAC	G7J-2A2B-T-W1 AC100/120
25 A @ 220 VAC	3PST-NO, SPST-NC	Screw	24 VDC	G7J-3A1B-BZ DC24
25 A @ 220 VAC	3PST-NO, SPST-NC	Screw	100/120 VAC	G7J-3A1B-W1 AC100/120
25 A @ 220 VAC	4PST-NO	Screw	100/120 VAC	G7J-4A-B-W1 AC100/120
25 A @ 220 VAC	4PST-NO	Screw	200/240 VAC	G7J-4A-B-W1 AC200/240
25 A @ 220 VAC	4PST-NO	Screw	24 VDC	G7J-4A-B-W1 DC24

Note: For Metal mounting Bracket, add "-W1" to the Part Number before the Coil voltage suffix.

## Multi-Pole High Power Relay

The G7Z can switch Contactor Range (40 A @ 440 VAC) and contribute to space saving.

- 40% less volume versus typical IEC 50 A contactor—great for limited space panels
- 3.7 W approximate power consumption about 50% lower than typical IEC 50 A contactor
- 4PST-NO models can carry up to 160 A by wiring all 4 NO Contacts in parallel
- Ideal applications are: solar energy systems, robotic equipment, and grinding machines
- Auxiliary contacts can switch loads under 10 mA @ 5 VDC = controllable by PLC
- RoHS Compliant; CE, cULus, TÜV and CCC Approved



## Ordering Information

Rated resistive load (NO Contact)	AC inductive load rating (NO Contact)	Contact form	Auxiliary Contact	Coil voltage	Model
40 A @ 440 VAC	22 A @ 440 VAC	DPST-NO, DPST-NC	-	24 VDC	G7Z-2A2B DC24
40 A @ 440 VAC	22 A @ 440 VAC	DPST-NO, DPST-NC	DPST-NC	24 VDC	G7Z-2A2B-02Z DC24
40 A @ 440 VAC	22 A @ 440 VAC	DPST-NO, DPST-NC	SPST-NO/SPST-NC	24 VDC	G7Z-2A2B-11Z DC24
40 A @ 440 VAC	22 A @ 440 VAC	3PST-NO, SPST-NC	SPST-NO/SPST-NC	24 VDC	G7Z-3A1B-11Z DC24
40 A @ 440 VAC	22 A @ 440 VAC	4PST-NO	DPST-NC	24 VDC	G7Z-4A-02Z DC24
40 A @ 440 VAC	22 A @ 440 VAC	4PST-NO	SPST-NO/SPST-NC	24 VDC	G7Z-4A-11Z DC24
40 A @ 440 VAC	22 A @ 440 VAC	4PST-NO	DPST-NO	24 VDC	G7Z-4A-20Z DC24

## Heavy-Duty General Purpose Relay with Class F Coil Insulation

The MGN is a rugged general purpose relay with high maximum operating temperature—great for heavy duty HVAC and Motor Loads.

- UL rating of 30 A @ 240 VAC/28 VDC and 20 A @ 600 VAC
- UL Ballast rating of 3.6 kW @ 120 VAC
- -45°C to +115°C DC coil operating temperature
- Short Circuit Current Rating (SCCR) of 5 kA @ 600 VAC
- Magnetic blow-out models switch up to 20 A @ 125 VDC (resistive)
- cULus Listed



## Ordering Information

Rated resistive load	Contact form	Terminal type	Size in inches (L x W x H)	UL horsepower rating	Coil voltage	Model
30 A @ 240 VAC	SPDT	Screw	2.5 x 2.5 x 2.2	1.5 HP @ 120 VAC	24 VAC	MGN1C-AC24
30 A @ 240 VAC	SPDT	Screw	2.5 x 2.5 x 2.2	1.5 HP @ 120 VAC	120 VAC	MGN1C-AC120
30 A @ 240 VAC	DPST-NO	Screw	2.5 x 2.5 x 2.2	1.5 HP @ 120 VAC	120 VAC	MGN2A-AC120
30 A @ 240 VAC	DPST-NO	Screw	2.5 x 2.5 x 2.2	1.5 HP @ 120 VAC	24 VDC	MGN2A-DC24
30 A @ 240 VAC	DPDT	Screw	3.4 x 2.5 x 2.4	1.5 HP @ 120 VAC	120 VAC	MGN2C-AC120
30 A @ 240 VAC	DPDT	Screw	3.4 x 2.5 x 2.4	1.5 HP @ 120 VAC	12 VDC	MGN2C-DC12
30 A @ 240 VAC	DPDT	Screw	3.4 x 2.5 x 2.4	1.5 HP @ 120 VAC	24 VDC	MGN2C-DC24
20 A @ 125 VAC	DPDT	Screw	3.4 x 2.5 x 2.4	1.5 HP @ 120 VAC	24 VDC	MGN2CM-DC24



## Compact 5-20 A Panel Mount Solid State Relay

The G3NE is a space-saving solid state relay which can switch 5 A, 10 A, or 20 A load @ 100-240 VAC.



- G3NE Relays have 65% less volume versus standard "hockey puck" SSRs
- Fast wiring possible using quick-connect input and output terminals
- Different size quick connect terminals prevent miss wiring: Input terminals require #110/Output terminals require #250
- Built in varistor prevents surges to protect output loads
- RoHS Compliant; "-US" Models have UL, CSA, and TÜV Approval



## Ordering Information

Input voltage	Load voltage	Load current	Size in mm L x W x H	Zero cross	Mounting	Model
5 VDC	100 to 240 VAC	0.1 to 5 A	48 x 38 x 12	Yes	Panel	G3NE-205T-US DC5
12 VDC	100 to 240 VAC	0.1 to 5 A	48 x 38 x 12	Yes	Panel	G3NE-205T-US DC12
24 VDC	100 to 240 VAC	0.1 to 5 A	48 x 38 x 12	Yes	Panel	G3NE-205T-US DC24
5 VDC	100 to 240 VAC	0.1 to 10 A	48 x 38 x 12	Yes	Panel	G3NE-210T-US DC5
12 VDC	100 to 240 VAC	0.1 to 10 A	48 x 38 x 12	Yes	Panel	G3NE-210T-US DC12
24 VDC	100 to 240 VAC	0.1 to 10 A	48 x 38 x 12	Yes	Panel	G3NE-210T-US DC24
5 VDC	100 to 240 VAC	0.1 to 10 A	48 x 38 x 12	Yes	Panel	G3NE-210T-2-US DC5
5 VDC	100 to 240 VAC	0.1 to 20 A	48 x 38 x 12	Yes	Panel	G3NE-220T-US DC5
12 VDC	100 to 240 VAC	0.1 to 20 A	48 x 38 x 12	Yes	Panel	G3NE-220T-US DC12
24 VDC	100 to 240 VAC	0.1 to 20 A	48 x 38 x 12	Yes	Panel	G3NE-220T-US DC24

## The Reliable Choice for "Hockey Puck Style" Solid State Relay. Available in a wide range of Load Current (5 A to 90 A) and Load Voltage (max. 660 VAC)

All G3NAs feature industry standard mounting holes for usability and versatility (optional heat sink is available). LED provides quick verification of G3NA operational status.

- Minimize surge and input noise by utilizing AC load models with zero cross
- Included plastic cover provides finger protection for workers' safety
- Built in varistor prevents surges to protect output loads
- All models have UL and CSA Approval: "UTU" models also have TÜV Approval. RoHS compliant.



## Ordering Information

Input voltage	Load voltage	Load current	Size in mm L x W x H	Zero cross	Mounting	Model
5 to 24 VDC	24 to 240 VAC	0.1 to 5 A	58 x 43 x 30	Yes	Panel	G3NA-205B DC5-24
100 to 120 VAC	24 to 240 VAC	0.1 to 10 A	58 x 43 x 30	Yes	Panel	G3NA-210B AC100-120
5 to 24 VDC	24 to 240 VAC	0.1 to 10 A	58 x 43 x 30	Yes	Panel	G3NA-210B DC5-24
5 to 24 VDC	24 to 240 VAC	0.1 to 10 A	58 x 43 x 30	Yes	Panel	G3NA-210B-UTU DC5-24
100 to 120 VAC	24 to 240 VAC	0.1 to 20 A	58 x 43 x 30	Yes	Panel	G3NA-220B AC100-120
5 to 24 VDC	24 to 240 VAC	0.1 to 20 A	58 x 43 x 30	Yes	Panel	G3NA-220B DC5-24
5 to 24 VDC	24 to 240 VAC	0.1 to 40 A	58 x 43 x 30	Yes	Panel	G3NA-240B DC5-24
5 to 24 VDC	200 to 480 VAC	0.2 to 40 A	58 x 43 x 30	Yes	Panel	G3NA-440B-2 DC5-24
100 to 240 VAC	24 to 240 VAC	1.0 to 75 A	58 x 43 x 30	Yes	Panel	G3NA-275B-UTU-2 AC100-240
5 to 24 VDC	24 to 240 VAC	1.0 to 90 A	58 x 43 x 30	Yes	Panel	G3NA-290B-UTU-2 DC5-24
5 to 24 VDC	5 to 200 VDC	0.1 to 10 A	58 x 43 x 27	No	Panel	G3NA-D210B DC5-24
5 to 24 VDC	400 to 600 VAC	0.5 to 50 A	58 x 43 x 30	Yes	Panel	G3NA-650B DC5-24

## High Power Solid State Relay with Heat Sink, Features Replaceable Output Power Cartridge

Applicable Load: 75 or 150 A @ 240 or 480 VAC

- Models available with zero crossing and non-zero crossing
- Conforms to cULus standards and EN standards (TÜV certification)



## Ordering Information

Insulation method	Operation indicator	Zero cross function	Applicable output load	Rated input voltage	Model
Photocoupler	Yes (yellow)	Yes	75 A, 100 to 240 VAC	5 to 24 VDC	G3PH-2075B DC5-24
				100 to 240 VAC	G3PH-2075B AC100-240
			150 A, 100 to 240 VAC	5 to 24 VDC	G3PH-2150B DC5-24
				100 to 240 VAC	G3PH-2150B AC100-240
		No	75 A, 100 to 240 VAC	5 to 24 VDC	G3PH-2075BL DC5-24
				5 to 24 VDC	G3PH-2150BL DC5-24
			150 A, 100 to 240 VAC	5 to 24 VDC	G3PH-5075B DC5-24
				100 to 240 VAC	G3PH-5075B AC100-240
		Yes	75 A, 180 to 480 VAC	5 to 24 VDC	G3PH-5150B DC5-24
				100 to 240 VAC	G3PH-5150B AC100-240
			150 A, 180 to 480 VAC	5 to 24 VDC	G3PH-5075BL DC5-24
				5 to 24 VDC	G3PH-5150BL DC5-24

## Solid State Relay with Built-in Heat Sink and Replaceable Power Cartridge

The G3PA is a DIN rail mounted Solid State Relay which can switch 10 - 60 A Loads.

- Quick and easy DIN rail mounting
- High Insulation voltage between input and output with 4,000 VAC
- Side-by-side mounting of 3 relays possible with G3PA linking terminals
- Reduce replacement cost and wiring time by using G3PA power cartridges
- 3 phase switching with G3PAs possible with G32A-D accessory cartridge
- RoHS Compliant; All G3PA models are certified by UL and CSA. "-VD" models are certified by UL, CSA and VDE



## Ordering Information

Input voltage	Load voltage	Load current	Size in mm L x W x H	Zero cross	Mounting	Model
24 VAC	24 to 240 VAC	0.1 to 10 A	100 x 27 x 100	Yes	DIN/panel	G3PA-210B-VD AC24
5 to 24 VDC	24 to 240 VAC	0.1 to 10 A	100 x 27 x 100	Yes	DIN/panel	G3PA-210B-VD DC5-24
5 to 24 VDC	24 to 240 VAC	0.1 to 10 A	100 x 27 x 100	No	DIN/panel	G3PA-210BL-VD DC5-24
5 to 24 VDC	24 to 240 VAC	0.1 to 10 A	100 x 37 x 100	Yes	DIN/panel	G3PA-220B-VD DC5-24
5 to 24 VDC	24 to 240 VAC	0.5 to 40 A	100 x 47 x 100	Yes	DIN/panel	G3PA-240B-VD DC5-24
5 to 24 VDC	24 to 240 VAC	0.5 to 60 A	110 x 100 x 100	Yes	DIN/panel	G3PA-260B-VD DC5-24
12 to 24 VDC	180 to 400 VAC	0.5 to 20 A	100 x 37 x 100	Yes	DIN/panel	G3PA-420B-VD DC12-24
12 to 24 VDC	180 to 400 VAC	0.5 to 30 A	100 x 47 x 100	Yes	DIN/panel	G3PA-430B-VD DC12-24
12 to 24 VDC	200 to 480 VAC	0.5 to 30 A	100 x 47 x 100	Yes	DIN/panel	G3PA-430B-VD-2 DC12-24
12 to 24 VDC	200 to 480 VAC	0.5 to 50 A	110 x 100 x 100	Yes	DIN/panel	G3PA-450B-VD-2 DC12-24

## Compact, Slim-profile SSRs with Built-in Heat Sink

The G3PE is capable of suppressing transient voltages (min. 30 kV).

- Quick and easy DIN rail mounting.
- 3-phase types are also available (G3PE-□□□B-3H type)
- Single-phase 15 A and 25 A models occupy less than 1" of DIN track width
- Side-by-side mounting of eight relays possible for single phase models
- Minimize surge and input noise by utilizing zero cross models
- All models are RoHS Compliant and have UL, CSA, CE, and TÜV Approvals



## Ordering Information

Input voltage	Load voltage	Load current	Size in mm L x W x H	Zero cross	Number of poles	Model
12 to 24 VDC	100 to 240 VAC	0.1 to 15 A	100 x 22.5 x 100	Yes	1	G3PE-215B DC12-24
12 to 24 VDC	100 to 240 VAC	0.1 to 15 A	100 x 22.5 x 100	Yes	1	G3PE-225B DC12-24
12 to 24 VDC	100 to 240 VAC	0.5 to 35 A	100 x 44.5 x 100	Yes	1	G3PE-235B DC12-24
12 to 24 VDC	100 to 240 VAC	0.5 to 45 A	100 x 44.5 x 100	Yes	1	G3PE-245B DC12-24
12 to 24 VDC	200 to 480 VAC	0.5 to 15 A	100 x 80 x 155	Yes	3	G3PE-515B-3N DC12-24
12 to 24 VDC	200 to 480 VAC	0.5 to 25 A	100 x 80 x 155	Yes	2	G3PE-525B-2N DC12-24
12 to 24 VDC	200 to 480 VAC	0.5 to 25 A	120 x 80 x 155	Yes	3	G3PE-525B-3N DC12-24
12 to 24 VDC	200 to 480 VAC	0.5 to 35 A	120 x 80 x 155	Yes	2	G3PE-535B-2N DC12-24
12 to 24 VDC	200 to 480 VAC	0.5 to 35 A	140 x 80 x 155	Yes	3	G3PE-535B-3N DC12-24
12 to 24 VDC	200 to 480 VAC	0.5 to 45 A	140 x 110 x 155	Yes	3	G3PE-545B-3N DC12-24
12 to 24 VDC	100 to 240 VAC	0.5 to 45 A	80 x 80 x 35	Yes	3	G3PE-245B-3H DC12-24

\* G3PE-□□□B-3H type is not built-in heat sink type.

## Built-in Current Transformer with Heater Burnout and Relay Failure Detection

Can handle up to 35 A @ 240 VAC with up to 2 alarm outputs when failure occurs.

- Current transformer is built into the SSR, therefore eliminating unnecessary CT wiring
- Heater burnout detection for single-phase or three-phase heaters
- Built-in CT can detect SSR short circuit failures
- Alarm indicator shows if a heater burnout or SSR short-circuit failure has occurred
- Rotary switches can be used to easily set the heater burnout detection level



## Ordering Information

Input terminal model	Zero cross function	Alarm output	Applicable load	Model
M3 terminals	Yes	1 output (Heater Burnout Detection, SSR short-circuit Failure Detection, Common)	2 to 25 A @ 100 to 240 VAC	G3PF-225B DC24
			2 to 35 A @ 100 to 240 VAC	G3PF-235B DC24
Screwless clamp terminals		2 outputs (Heater Burnout Detection, SSR Short-circuit Failure Detection)	2 to 35 A @ 100 to 240 VAC	G3PF-235B-CTB DC24
Compact slotted screw terminals			2 to 35 A @ 100 to 240 VAC	G9PF-235B-STB DC24

## Solid State Plug-in Ultra-Slim Relay

The G3RV is an ultra-slim 6 mm wide solid state relay in a DIN mount relay-socket unit with maintenance-friendly features.

- LED indicator allows verification of current flow of input
- Large plug-in terminal ensures reliable connection
- PLC interface and cable accessories are available
- Easily connect multiple G3RV Relays together with cross bars
- RoHS Compliant; cULus Listed, CE and TÜV Approval
- G3RV Class I Division 2 meets requirements: Non-incendive Electrical Equipment for Use in Class I, Division 2 Hazardous Locations

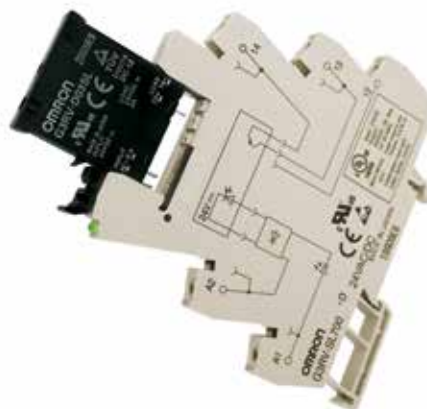

## Ordering Information

Terminal wiring connection	Input voltage	Load voltage	Load current	Zero cross	Model
Push-in	230 VAC	100 to 240 VAC	0.1 to 2 A	Yes	G3RV-SL500-A AC230
	24 VDC	100 to 240 VAC	0.1 to 2 A	Yes	G3RV-SL500-A DC24
	230 VAC	5 to 24 VDC	100 µA to 3 A	-	G3RV-SL500-D AC230
	24 VDC	5 to 24 VDC	100 µA to 3 A	-	G3RV-SL500-D DC24
Screw	110 VAC	100 to 240 VAC	0.1 to 2 A	Yes	G3RV-SL700-A AC110
	230 VAC	100 to 240 VAC	0.1 to 2 A	Yes	G3RV-SL700-A AC230
	24 VDC	100 to 240 VAC	0.1 to 2 A	Yes	G3RV-SL700-A DC24
	110 VAC	100 to 240 VAC	0.1 to 2 A	No	G3RV-SL700-AL AC110
	110 VAC	5 to 24 VDC	100 µA to 3 A	-	G3RV-SL700-D AC110
	24 VDC	5 to 24 VDC	100 µA to 3 A	-	G3RV-SL700-D DC24

Note: Model number contains relay and socket.

## G3RV Class 1 Division 2 meets requirements: Groups A,B,C and D

Terminal wiring connection	Input voltage	Load voltage	Load current	Zero cross	Model	
Push-in	12 VDC	100 to 240 VAC	0.1 to 2 A	Yes	G3RV-SL500-A-C1D2 DC12	
	24 VDC	100 to 240 VAC	0.1 to 2 A	Yes	G3RV-SL500-A-C1D2 DC24	
	110 VAC	100 to 240 VAC	0.1 to 2 A	Yes	G3RV-SL500-A-C1D2 AC110	
	230 VAC	100 to 240 VAC	0.1 to 2 A	Yes	G3RV-SL500-A-C1D2 AC230	
	12 VDC	5 to 24 VDC	100 µ to 3A	-	G3RV-SL500-D-C1D2 DC12	
	24 VDC	5 to 24 VDC	100 µ to 3A	-	G3RV-SL500-D-C1D2 DC24	
	110 VAC	100 to 240 VAC	0.1 to 2 A	Yes	G3RV-SL500-D-C1D2 AC110	
	230 VAC	100 to 240 VAC	0.1 to 2 A	Yes	G3RV-SL500-D-C1D2 AC230	
	12 VDC	5 to 24 VDC	100 µ to 3A	-	G3RV-SL500-AL-C1D2 DC12	
	24 VDC	5 to 24 VDC	100 µ to 3A	-	G3RV-SL500-AL-C1D2 DC24	
	110 VAC	100 to 240 VAC	0.1 to 2 A	Yes	G3RV-SL500-AL-C1D2 AC110	
	230 VAC	100 to 240 VAC	0.1 to 2 A	Yes	G3RV-SL500-AL-C1D2 AC230	
	Screw	12 VDC	100 to 240 VAC	0.1 to 2 A	Yes	G3RV-SL700-A-C1D2 DC12
		24 VDC	100 to 240 VAC	0.1 to 2 A	Yes	G3RV-SL700-A-C1D2 DC24
110 VAC		100 to 240 VAC	0.1 to 2 A	Yes	G3RV-SL700-A-C1D2 AC110	
230 VAC		100 to 240 VAC	0.1 to 2 A	Yes	G3RV-SL700-A-C1D2 AC230	
12 VDC		5 to 24 VDC	100 µ to 3A	-	G3RV-SL700-D-C1D2 DC12	
24 VDC		5 to 24 VDC	100 µ to 3A	-	G3RV-SL700-D-C1D2 DC24	
110 VAC		100 to 240 VAC	0.1 to 2 A	Yes	G3RV-SL700-D-C1D2 AC110	
230 VAC		100 to 240 VAC	0.1 to 2 A	Yes	G3RV-SL700-D-C1D2 AC230	
12 VDC		5 to 24 VDC	100 µ to 3A	-	G3RV-SL700-AL-C1D2 DC12	
24 VDC		5 to 24 VDC	100 µ to 3A	-	G3RV-SL700-AL-C1D2 DC24	

## Space Saving Input/Output Socket Mounted Solid State Relay

The G3R-I/O is a high isolation solid state relay ideal for PLC applications.



- High Insulation voltage between input and output with 4,000 VAC
- Process high-speed inputs using G3R-IDZR models: 0.1 ms max. On/Off time
- Applicable load up to 2 A @ 240 VAC with AC output models
- LED indicator allows verification of current flow of input
- Terminal arrangement equivalent with G2RS relay (socket: P2R series)
- RoHS Compliant; All G3R-I/O have UL and CSA approval, "-UTU" models have UL, CSA and TÜV approval



## Ordering Information

Input voltage	Load voltage	Load current	Size in mm L x W x H	Zero cross	Mounting	Model
5 VDC	4 to 32 VDC	0.1 to 100 mA	29 x 13 x 28	No	Socket	G3R-IDZR1SN DC5
12 to 24 VDC	4 to 32 VDC	0.1 to 100 mA	29 x 13 x 28	No	Socket	G3R-IDZR1SN DC12-24
5 to 24 VDC	100 to 240 VAC	0.05 to 2 A	29 x 13 x 28	Yes	Socket	G3R-OA202SZN DC5-24
5 to 24 VDC	100 to 240 VAC	0.05 to 2 A	29 x 13 x 28	Yes	Socket	G3R-OA202SZN-UTU DC5-24
5 to 24 VDC	48 to 200 VDC	0.01 to 1.5 A	29 x 13 x 28	No	Socket	G3R-OD201SN DC5-24
5 to 24 VDC	5 to 48 VDC	0.01 to 2 A	29 x 13 x 28	No	Socket	G3R-ODX02SN DC5-24
5 to 24 VDC	5 to 48 VDC	0.01 to 2 A	29 x 13 x 28	No	Socket	G3R-ODX02SN-UTU DC5-24

Note: Corresponding sockets can be found on page Y-vii.



## Ultra-Slim PCB Solid State Relays with Reinforced Insulation

PCB mount DC input and AC output SSR.

- 4.5 mm thin design for high-density PCB applications
- DC input and AC output for applicable load of 1 A (at 40°C) and 2 A (at 25°C)
- High Insulation voltage between input and output with 3,000 VAC for "-1" model
- RoHS Compliant; All G3MC models have UL, CSA approval and "-VD" models have additional VDE approval



## Ordering Information

Input voltage	Load voltage	Load current	Size in mm L x W x H	Zero cross	Insulation (input/output)	Model
5 VDC	100 to 120 VAC	0.1 to 1 A	24.5 x 4.5 x 13.5	Yes	2500 VAC	G3MC-101P DC5
5 VDC	100 to 120 VAC	0.1 to 1 A	24.5 x 4.5 x 13.5	Yes	2500 VAC	G3MC-101P-VD DC5
5 VDC	100 to 240 VAC	0.1 to 2 A	24.5 x 4.5 x 20.5	Yes	2500 VAC	G3MC-202P-VD DC5
24 VDC	100 to 240 VAC	0.1 to 2 A	24.5 x 4.5 x 20.5	Yes	3000 VAC	G3MC-202P-VD-1 DC24
5 VDC	100 to 240 VAC	0.1 to 2 A	24.5 x 4.5 x 20.5	No	2500 VAC	G3MC-202PL-VD DC5
12 VDC	100 to 240 VAC	0.1 to 2 A	24.5 x 4.5 x 20.5	No	2500 VAC	G3MC-202PL-VD DC12

## Input/Output Color-Coded PCB Solid-State Relays with LED Indicator Models

The G3TB is a PCB mount Input/Output solid state relay with width (10 mm width).

- High Insulation voltage between input and output with 4,000 VAC
- Easy to identify (black: AC output, Yellow: AC Input, Red: DC output, White: DC input)
- RoHS Compliant; "-US" Models have UL and CSA Approval



## Ordering Information

Input voltage	Load voltage	Load current	Size in mm L x W x H	Zero cross	Relay color	Model
100 to 240 VAC	4 to 32 VDC	25 mA max.	44 x 10 x 21	No	Yellow	G3TB-IAZR02P-US AC100-240
4 to 24 VDC	4 to 32 VDC	25 mA max.	44 x 10 x 21	-	White	G3TB-IDZR02P-US DC5-24
5 to 24 VDC	100 to 240 VAC	0.05 to 3 A	44 x 10 x 31	Yes	Black	G3TB-OA203PZ-US DC5-24
4 to 24 VDC	5 to 48 VDC	0.01 to 3 A	44 x 10 x 31	-	Red	G3TB-ODX03PM-US DC4-24

<b>Contents</b>		
Selection Guide		Z-iv
<b>Pilot Lights</b>		
M22R	Pilot lights	Z-2
<b>22 mm dia. metal bezel, pushbutton switches</b>		
A22R/ A22RL	Pushbutton switches Lighted pushbutton switches	Z-3
A22RS/ A22RW	Selector switches Lighted selector switches	Z-4
A22RK	Keyed selector switches	Z-4
<b>22 mm dia. plastic bezel, pushbutton switches</b>		
A3U	Flat type, pushbutton switches	Z-5
<b>16 mm dia. plastic bezel, pushbutton and selector switches</b>		
A16/ A16L/ A165/ A165L	Pushbutton switches Lighted pushbutton switches IP65 Pushbutton switches IP65 Lighted pushbutton switches	Z-6
A165S/ A165W	Selector switches Lighted selector switches	Z-7
A165K	Keyed selector switches	Z-8
M16/ M165	Pilot lights IP65 Pilot lights	Z-9
M2BJ	Panel-mounted buzzer	Z-10
<b>30 mm dia. non-lighted, pushbutton switches</b>		
ZAP	Pushbutton switches	Z-10



## OMRON OFFERS A BROAD RANGE OF PUSHBUTTON SWITCHES

### ADVANTAGES FOR PANEL BUILDERS

Omron's pushbutton and selector switches, and pilot lights support control panel designs with shallow mounting depths. They deliver time-saving, easy installation that reduces project labor cost. Panel builders can reduce component ordering expenses by specifying multiple Omron industrial controls.

- 16, 22 and 30 mm diameters
- Wide range of shapes and colors
- Contact configurations for most applications



- Continuous illumination on pilot lights and lighted pushbutton switches
- Momentary and alternate switch action
- Keyed and knob selector switches
- Metal or plastic bezels available





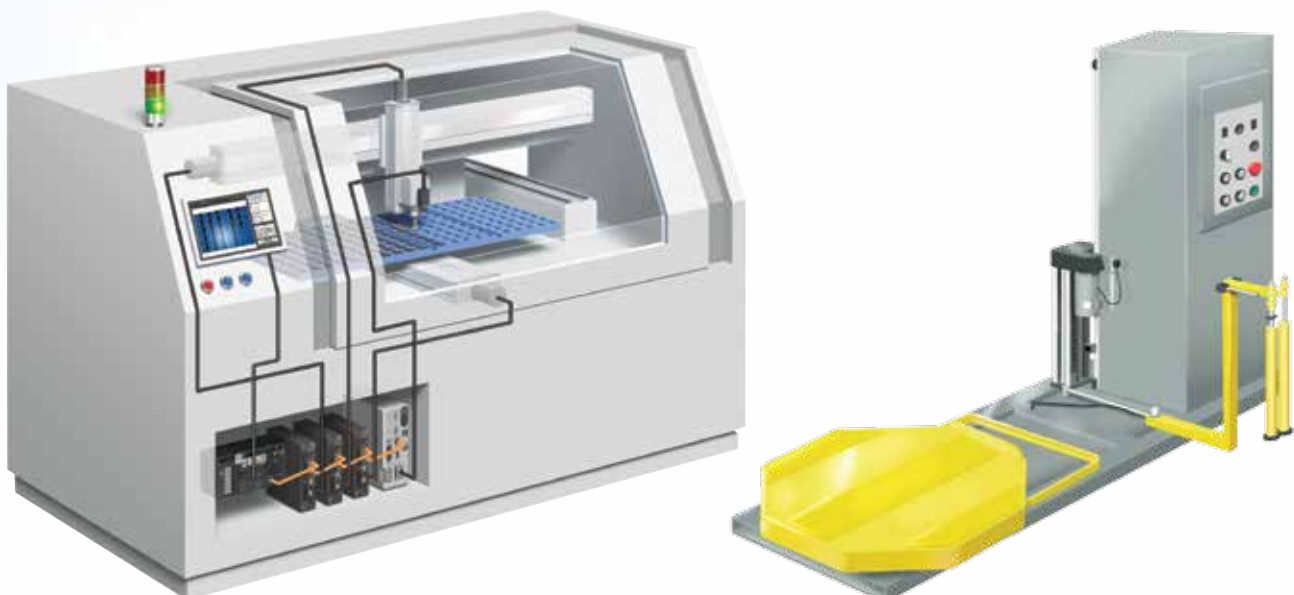









### TYPICAL APPLICATIONS

- Packaging equipment
- Food & beverage production
- Semiconductor manufacturing machines



















# Selection Table

Category		Pushbutton switch				Indicator		Buzzer		
										
Selection criteria	Model	A16/A165	A22R	A3U	ZAP	M16/M165	M22R	M2JB-B		
	Mounting	Nut-mounting								
	Size	16 mm	22 mm	22 mm	30 mm	16 mm	22 mm	16 mm		
	Shape									
Pushbutton color	LED-lighted	Red	■	■	■	—	■	■	—	
		Yellow	■	■	■	—	■	■	—	
		Pure yellow	■	—	—	—	■	—	—	
		Green	■	■	■	—	■	■	—	
		White	■	■	■	—	■	■	—	
		Blue	■	■	■	—	■	■	—	
	Non-lighted	Red	■	■	■	■	—	—	—	
		Yellow	■	■	■	■	—	—	—	
		Green	■	■	■	■	—	—	—	
		White	■	■	■	■	—	—	—	
		Blue	■	■	■	■	—	—	—	
		Black	■	■	■	■	—	—	■	
		Features		Momentary operation	■	■	■	—	—	—
				Self-holding	■	■	—	—	—	—
		2-position selector	—	—	—	—	—	—		
		3-position selector	—	—	—	—	—	—		
		Number of contacts	1 or 2	1 or 2	1 or 2	1 or 2	—	—		
		IP rating	IP40/IP65	IP65	IP40	—	IP40/IP65	IP65		
		Legend plate	■	■	■	—	■	■		
		Switch ratings (Resistive load)	• 5 A, 125 VAC • 3 A, 250 VAC • 3 A, 30 VDC	• 3 A, 240 VAC	• 0.1 A, 30 VDC	• 15 A, 250 VAC • 0.5 A, 125 VDC	—	—		
Terminals	Solder	■	—	—	—	■	—	■		
	PCB	■	—	—	—	■	—	—		
	Screw-less clamp	■	—	—	—	■	—	—		
	Screw	—	■	—	■	—	■	—		
	Connector	—	—	■	—	—	—	—		
LED Operating voltage	5 VDC	■	—	■	—	■	—	—		
	6 VDC	—	■	—	—	—	■	—		
	12 VDC	■	■	■	—	■	■	—		
	24 VDC	■	■	■	—	■	■	—		
	110 VAC	■	—	—	—	■	—	—		
	220 VAC	■	■	—	—	■	■	—		
Form	SPDT	■	—	■	■	—	—	—		
	DPDT	■	—	■	■	—	—	—		
	SPST-NO	—	■	—	—	—	—	—		
	SPST-NC	—	■	—	—	—	—	—		
	SPST-NO + SPST-NC	—	■	—	—	—	—	—		
	DPST-NO	—	■	—	—	—	—	—		
	DPST-NC	—	■	—	—	—	—	—		

■ Standard    □ Available    — No/not available

# Pushbutton Switches

Category		Selector switch							
									
Selection criteria	Model	A165W	A165S	A165K	A22RW	A22RS	A3US	A22RK	
	Mounting							Nut-mounting	
	Size	16 mm	16 mm	16 mm	22 mm	22 mm	22 mm	22 mm	
	Shape								
Pushbutton color	LED-lighted	Red	■	—	—	■	—	—	
		Yellow	■	—	—	■	—	—	
		Pure yellow	—	—	—	—	—	—	
		Green	■	—	—	■	—	—	
		White	—	—	—	—	—	—	
		Blue	—	—	—	■	—	—	
	Non-lighted	Red	—	—	—	—	—	—	
		Yellow	—	—	—	—	—	—	
		Green	—	—	—	—	—	—	
		White	—	—	—	—	—	—	
		Blue	—	—	—	—	—	—	
		Black	—	■	■	—	■	■	
	Features	Momentary operation	—	—	—	—	—	—	
		Self-holding	—	—	—	—	—	—	
2-position selector		■	■	■	■	—	■		
3-position selector		■	■	■	■	—	■		
Number of contacts		1 or 2	1 or 2	1 or 2	1 or 2	—	1	1 or 2	
IP rating		IP65	IP65	IP65	IP65	IP65	IP40	IP65	
Legend plate	—	—	—	—	■	—	—		
Switch ratings (Resistive load)	Switch ratings (Resistive load)	• 5 A, 125 VAC • 3 A, 250 VAC • 3 A, 30 VDC	• 5 A, 125 VAC • 3 A, 250 VAC • 3 A, 30 VDC	• 5 A, 125 VAC • 3 A, 250 VAC • 3 A, 30 VDC	• 3 A, 240 VAC	• 3 A, 240 VAC	• 0.1 A, 30 VDC	• 3 A, 240 VAC	
Terminals	Solder	■	■	■	—	—	—		
	PCB	■	■	■	—	—	—		
	Screw-less clamp	■	■	■	—	—	—		
	Screw	—	—	—	■	■	—		
	Connector	—	—	—	—	—	■		
LED Operating voltage	5 VDC	■	—	—	—	—	—		
	6 VDC	—	—	—	■	—	—		
	12 VDC	■	—	—	■	—	—		
	24 VDC	■	—	—	■	—	—		
	110 VAC	■	—	—	—	—	—		
	220 VAC	■	—	—	■	—	—		
Form	SPDT	■	■	■	—	—	■		
	DPDT	■	■	■	—	—	—		
	SPST-NO	—	—	—	■	■	—		
	SPST-NC	—	—	—	■	■	—		
	SPST-NO + SPST-NC	—	—	—	■	■	—		
	DPST-NO	—	—	—	■	■	—		
	DPST-NC	—	—	—	■	■	—		

■ Standard    □ Available    — No/not available

## 22 mm Dia. Pilot Lights

- Pilot lights indicate status of machinery and processes on control panels
- Bright LED light source is easy to read under most lighting conditions
- Easy mounting and removal of socket unit
- Short mounting depth, less than 40.5 mm below panel



## Specifications

- Current consumption:  
 20 mA @ 12 V AC/DC  $\pm 5\%$   
 20 mA @ 24 V AC/DC  $\pm 5\%$
- Enclosure rating: IP65

Pilot lights		Model
Round flat pilot light 		M22R

• LED Lamp Ratings		
Model	Operating Voltage	Current Consumption
M22R-E*-12A	AC/DC 12 V $\pm 5\%$	20 mA
M22R-E*-24A	AC/DC 24 V $\pm 5\%$	20 mA
M22R-E*-T1	AC120 V (110 to 130 V)	20 mA
M22R-E*-T2	AC200 V (190 to 230 V)	20 mA



# A22R/A22RL Series Pushbutton Switches

Quick Link

P642

omron247.com

## 22 mm Dia. Lighted and Non-Lighted Pushbutton Switches



- Robust and aesthetic design
- Shiny metal bezel
- Smooth rounded edges
- Short mounting depth, less than 46.8 mm below panel





## Specifications

- Rated load: 3 A at 240 VAC
- Enclosure rating: IP65
- Rated durability service life:
  - Mechanical:
    - 3,000,000 operations - Momentary switch
    - 300,000 operations - Alternate switch
  - Electrical: 500,000 operations



Non-Lighted		Model
Round flat ● ● ● ● ● ●		A22R-F
Round projection ● ● ● ● ● ●		A22R-T

Lighted		Model
Lighted round flat ● ● ● ● ●		A22RL-F
Lighted round projection ● ● ● ● ●		A22RL-T

• LED Lamp Ratings		
Model	Operating Voltage	Current Consumption
A22R-6A	AC/DC 6 V ± 5%	20 mA
A22R-12A	AC/DC 12 V ± 5%	20 mA
A22R-24A	AC/DC 24 V ± 5%	20 mA
• Voltage reduction unit (for LED lamp)		
Model	Operating Voltage	Current Consumption
A22R**-T1	AC120 V (110 to 130 V)	20 mA
A22R**-T2	AC200 V (190 to 230 V)	20 mA

# A22RS/A22RW Series Selector Switches

Quick Link  
P643  
omron247.com

## 22 mm Dia. Lighted and Non-Lighted Selector Switches

- 2- and 3-position switches with manual or automatic reset to meet panel building needs
- New “super-bright” LED used in all lighted models
- Short mounting depth, less than 46.8 mm below panel
- “Snap-in” switch unit for quick and easy tool-free assembly
- Shiny metal bezel



### Specifications

- Rated load: 3 A at 240 VAC
- Enclosure rating: IP65
- Rated durability service life:
  - Mechanical: 300,000 operations
  - Electrical: 500,000 operations

Non-Lighted		Model
Non-lighted selector switch ●		A22RS

Lighted		Model
Lighted selector switch ● ● ● ●		A22RW

# A22RK Series Keyed Selector Switches

Quick Link  
P644  
omron247.com

## 22 mm Dia. Keyed Non-Lighted Selector Switches

- Design in extra security with keyed selector switches; only authorized operators are allowed to change settings using the key
- 2- and 3-position switches with manual or automatic reset to meet panel building needs
- Short mounting depth, less than 46.8 mm below panel
- “Snap-in” switch unit for quick and easy tool-free assembly
- Shiny metal bezel



### Specifications

- Rated load: 3 A at 240 VAC
- Enclosure rating: IP65
- Rated durability service life:
  - Mechanical: 300,000 operations
  - Electrical: 500,000 operations

Keyed		Model
Keyed selector switch ●		A22RK

## 22 mm Dia. Flat-type Lighted and Non-Lighted Pushbutton Switches and Selector Switch

Easy connector enables less assembly and less wiring.





- 50 mm body length
- Easy one push to connect the Operation and Switch units



### Specifications

- Rated load: 0.1 A @ 30 VDC
- Rated durability service life:
  - Mechanical:
    - 1,000,000 operations - Pushbutton switches
    - 250,000 operations - Selector switch
  - Electrical:
    - 200,000 operations - Pushbutton switches
    - 1000,000 operations - Selector switch
- Enclosure: IP40



Pushbutton switches		Model
Lighted 		A3U
Non-lighted 		A3UL

Selector switch		Model
Non-lighted 		A3US



## 16 mm Dia. Lighted and Non-Lighted Pushbutton Switches

- Wide range of options to match most panel building needs
- Protection: IP65 oil-resistant models (A165) and standard IP40 models (A16)
- Lighting: Non-lighted (A16 and A165) and lighted (A16L and A165L)
- New “ultra-bright” LED used in all lighted models
- Short mounting depth, less than 28.5 mm below panel



- “Snap-in” switch unit for quick and easy tool-free assembly
- RoHS compliant

## Specifications

- Rated load (SPDT, DPDT):
  - 5 A at 125 VAC, 3 A at 250 VAC (NO & NC)
  - 3 A at 30 VDC
- Operating force:
  - SPDT 2.45N/DPDT:4.41N(IP40); SPDT:2.94N/DPDT4.91 N (IP65)
- Rated durability service life:
  - Mechanical: Momentary operation: 2,000,000 operations min.; Alternating operation: 200,000 operations min.
  - Electrical: 100,000 operations min.
- Approvals:
  - UL: UL508, File No. E41515
  - cUL: CSA C22 No. 14
  - TÜV: EN60947-5-1:2004
  - CCC: GB14048.5

Round Projection		Model
Lighted ● ● ● ● ● ●		A16L-T, A165L-T
Non-Lighted ● ● ● ● ● ●		A16-T, A165-T
Lighted, 110 VAC transformer ● ● ● ● ● ●		A16L-T-T1, A165L-T-T1
Lighted, 220 VAC transformer ● ● ● ● ● ●		A16L-T-T2, A165L-T-T2

Square		Model
Unlit, 2-way guard ● ● ● ● ● ●		A16-A, A165-A
Lit, 2-way guard ● ● ● ● ● ●		A16L-A, A165L-A
Lighted square 2-way guard, 110 VAC transformer ● ● ● ● ● ●		A16L-A-T1, A165L-A-T1
Lighted square 2-way guard, 220 VAC transformer ● ● ● ● ● ●		A16L-A-T2, A165L-A-T2

Rectangular		Model
Unlit, 2-way guard ● ● ● ● ● ●		A16-J, A165-J
Lit, 2-way guard ● ● ● ● ● ●		A16L-J, A165L-J
Lighted rectangular 2-way guard 110 VAC transformer ● ● ● ● ● ●		A16L-J-T1, A165L-J-T1
Lighted rectangular 2-way guard, 220 VAC transformer ● ● ● ● ● ●		A16L-J-T2, A165L-J-T2

## 16 mm Dia. Lighted and Non-Lighted Selector Switches

- Knob-style selector switches provide users a reliable way to start or choose between machine operations
- 2- and 3-position switches with manual or automatic reset to meet panel building needs
- IP65-rated for oil resistance
- Lighting: Non-lighted (A165S) and lighted (A165W)
- New “ultra-bright” LED used in all lighted models
- Short mounting depth, less than 28.5 mm below panel
- “Snap-in” switch unit for quick and easy tool-free assembly





- RoHS compliant
- Use optional legend plates to identify the selections

## Specifications

- Rated load (SPDT, DPDT):
  - 5 A at 125 VAC, 3 A at 250 VAC (NO & NC)
  - 3 A at 30 VDC
- Operating force:
  - SPDT/DPDT: 0.1 Nm
- Rated durability service life:
  - Mechanical: 250,000 operations min.
  - Electrical: 100,000 operations min.
- Approvals:
  - UL: UL508, File No. E41515
  - cUL: CSA C22 No. 14
  - TÜV: EN60947-5-1:2004
  - CCC: GB14048.5

Non-lighted		Model
Square base selector switch ●		A165S-A
Rectangular base selector switch ●		A165S-J
Round base selector switch ●		A165S-T

Lighted		Model
Lighted square base selector switch ● ● ●		A165W-A
Lighted rectangular base selector switch ● ● ●		A165W-J
Lighted round base selector switch ● ● ●		A165W-T



## 16 mm Dia. Keyed Selector Switches

- Design in extra security with keyed selector switches; only authorized operators are allowed to change settings using the key
- 2- and 3-position switches with manual or automatic reset to meet panel building needs
- IP65-rated for oil resistance
- Short mounting depth, less than 28.5 mm below panel
- “Snap-in” switch unit for quick and easy tool-free assembly
- RoHS compliant
- Use optional legend plates to identify the selections



## Specifications

- Rated load (SPDT, DPDT):
  - 5 A at 125 VAC, 3 A at 250 VAC (NO & NC)
  - 3 A at 30 VDC
- Operating force:
  - SPDT/DPDT: 0.1 Nm
- Rated durability service life:
  - Mechanical: 250,000 operations min.
  - Electrical: 100,000 operations min.
- Approvals:
  - UL: UL508, File No. E41515
  - cUL: CSA C22 No. 14
  - TÜV: EN60947-5-1:2004
  - CCC: GB14048.5

Keyed switches		Model
Square base keyed selector switch ●		A165K-A
Rectangular base keyed selector switch ●		A165K-J
Round base keyed selector switch ●		A165K-T

## 16 mm Dia. Pilot Lights

- Pilot lights indicate status of machinery and processes on control panels
- Bright LED light source is easy to read under most lighting conditions
- Easy mounting and removal of socket unit
- Standard IP40 and oil-resistant IP65 models
- Short mounting depth, less than 28.5 mm below panel
- RoHS compliant
- Use optional legend plates to identify indicators



## Specifications

- Current consumption:
  - 8 mA @ 5 VDC  $\pm 5\%$
  - 8 mA @ 12 VAC/VDC  $\pm 5\%$
  - 8 mA @ 24 VAC/VDC  $\pm 5\%$
  - 8 mA @ 110 VAC/VDC
  - 8 mA @ 220 VAC/VDC
- Approvals:
  - UL: UL508, File No. E76675
  - cUL: CSA C22 No. 14

Keyed switches		Model
Square pilot light 		M16-A, M165-A
Rectangular pilot light 		M16-J, M165-J
Round pilot light 		M16-T, M165-T

Z

# M2BJ Series Buzzers

Quick Link  
P637  
omron247.com

## 16 mm Dia. Panel-Mounted Buzzers



- Intermittent or continuous sound selected by jumper setting
- Complements the A16 range of Pushbuttons, Selector Switches and Key Switches
- RoHS compliant
- LEDs incorporated on high-sound model indicators



### Specifications:

#### Current consumption:

- Standard sound types:
  - DC: 7 mA max.
  - AC: 20 mA max.
- High-sound (includes LED) types:
  - DC: 50 mA max.
  - AC: 100 mA max.

Buzzers		Model
Standard sound buzzer		M2BJ-B
High volume sound buzzer		M2BJ-BH

# ZAP Series Non-lighted Pushbutton Switches

Quick Link  
P654  
omron247.com

## 30 mm Dia. Non-lighted Pushbutton Switches

- Using a Basic Switch enables direct switching of large-capacity loads
- Shock-absorbing structure of Operation unit protects the Switch
- IP65 rated pushbutton structure enables use in dusty locations and resists oil and water splashes
- Pushbuttons are available in three shapes and six colors



### Specifications

- Rated load: 15 A at 250 VAC, 0.5 A at 125 VDC
- Electrical durability: 500,000 operations minimum

Shape of Operation Unit	Output	Operation Unit Color					
		Blue (-A)	Black (-B)	Green (-G)	Red (-R)	White (-W)	Yellow (-Y)
36 dia chrome bezel, 25 dia button	1	ZAP-A	ZAP-B	ZAP-G	ZAP-R	ZAP-W	ZAP-Y
	2	2ZAP-A	2ZAP-B	2ZAP-G	2ZAP-R	2ZAP-W	2ZAP-Y
36 dia chrome bezel, 25 dia button	1	ZAP-1A	ZAP-1B	ZAP-1G	ZAP-1R	ZAP-1W	ZAP-1Y
	2	2ZAP-1A	2ZAP-1B	2ZAP-1G	2ZAP-1R	2ZAP-1W	2ZAP-1Y
36 dia chrome bezel, 40 dia button	1	ZAP-2A	ZAP-2B	ZAP-2G	ZAP-2R	ZAP-2W	ZAP-2Y
	2	2ZAP-2A	2ZAP-2B	2ZAP-2G	2ZAP-2R	2ZAP-2W	2ZAP-2Y



# MAKING SAFETY SIMPLE — OMRON'S CONCEPT FOR THE FUTURE

Today, forward-thinking manufacturers clearly realize the new role of increased safety on the factory floor.

- Recently adopted international safety standards have shifted the way systems are evaluated.
- Safety is a corporate responsibility, not an obstruction to productivity.
- Safety is essential to increased productivity and profitability.

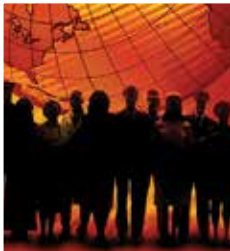

“The modern user of safety products demands a new vision.”

Poised at the leading-edge of safety solutions worldwide, Omron's STI safety products focus on making safety work.

We are aware of the many demands of automation safeguarding. Consequently, our automation safety products meet or exceed local and international safety standards.

Omron is committed to providing safeguarding solutions that meet your needs for safety and productivity. We design and engineer our products by listening to and working closely with our customers and authorized distributors. We also provide you with:

- Experienced assistance
- Expert guidance in application, integration and maintenance
- World-class support through Omron's global network of 250 sales locations in 65 countries

## ENHANCED WORKER SAFETY

### 1 Safety Light Curtains

The MS4800 and F3SJ models are simple to install, and available in a wide selection of protected heights and resolutions.

See page AA-i.



### 2 Safety Laser Scanners



OS32C

Our OS32C is a very compact safety laser scanner. It has 70 zone configurations for complex guarding parameters. Safety coverage up to 4 m at 270 degrees.

See page BB-i.

**New Industry First!**  
EtherNet/IP capable of status and measurement data reporting.

### 3 Safety Interlock Switches

Tamper resistant switches enhance mechanical guarding methods.

- Guardlocking switches
- Hinge pin switches
- Non-contact switches
- Limit switches
- Tongue switches
- Explosion-proof versions

See page EE-i.



A4EG

### 8 Enabling Switches

Provides the additional protection needed during set-up, programming and servicing of robotic and automatic equipment.

- Has distinct clicks for three easily discernible positions

See page GG-i.

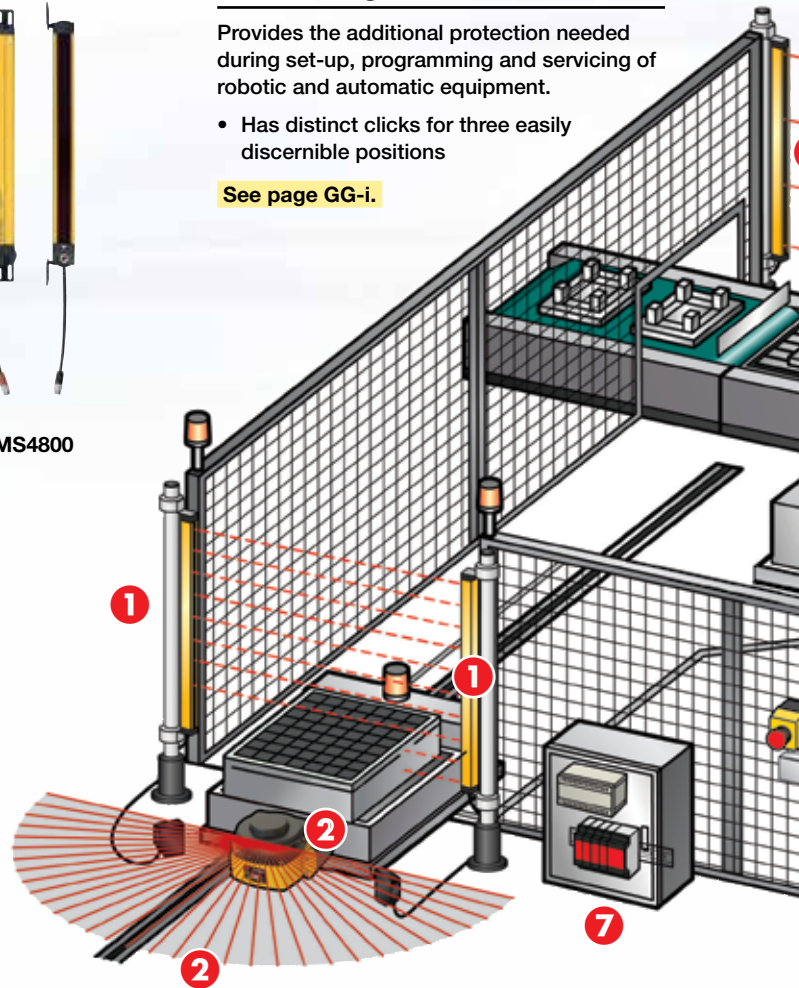

## 7 Safety Programmable Controllers

### 7 Safety Monitoring Relays

The G9SP stand-alone programmable safety controller for mid-sized applications supports direct connection to safety mats and non-contact switches. The NE1A DeviceNet safety network controller is well-suited for large complex applications, while safety monitoring relays are ideal for ensuring control reliability in smaller applications.

- Multiple input versions
- Delayed outputs
- Two-hand control
- Stop motion sensing

See page DD-i and page FF-i.



## 6 Perimeter Guarding

PA4600 models are available with single and multiple-beam models with an operating range to 70 meters. They're perfect when installing fences is not practical.

See page AA-i.

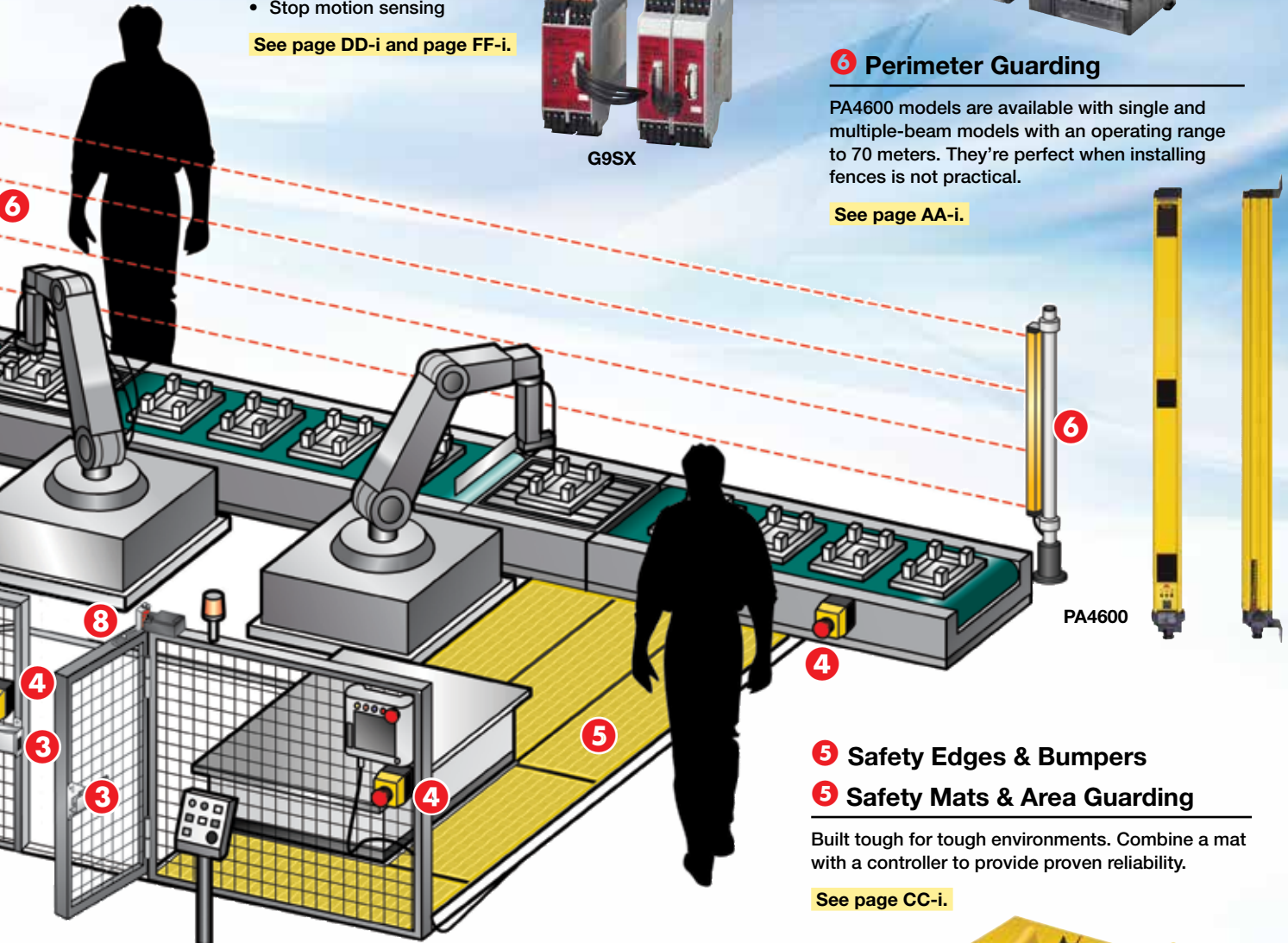

## 5 Safety Edges & Bumpers

### 5 Safety Mats & Area Guarding

Built tough for tough environments. Combine a mat with a controller to provide proven reliability.

See page CC-i.



## 4 Emergency Stop Devices

- Enclosed and panel-mounted models available with key-operated reset.
- Combination rope and push button actuated emergency stop switches.
- Heavy duty housing offering rope spans to 200 meters

See page FF-i.



# Machine & Process Safeguarding

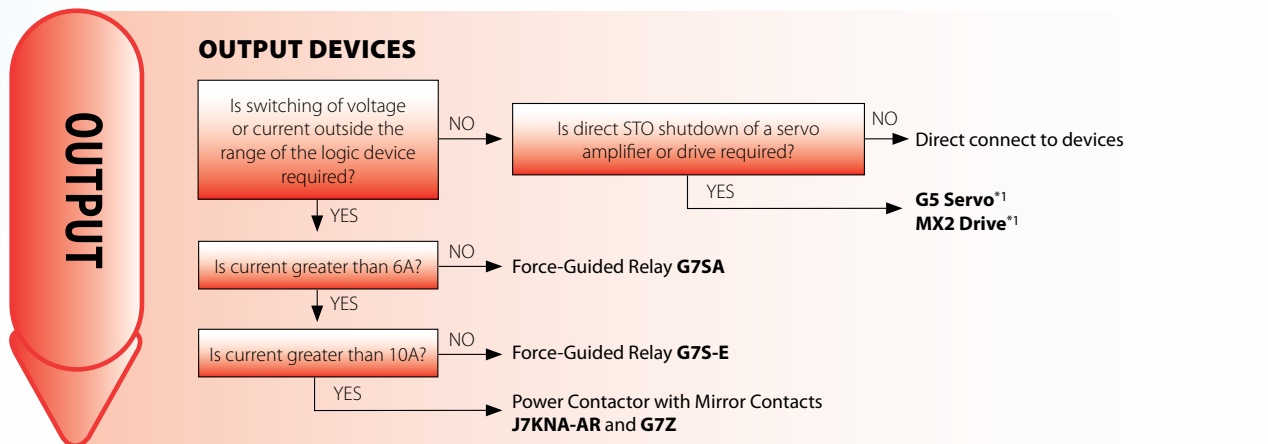
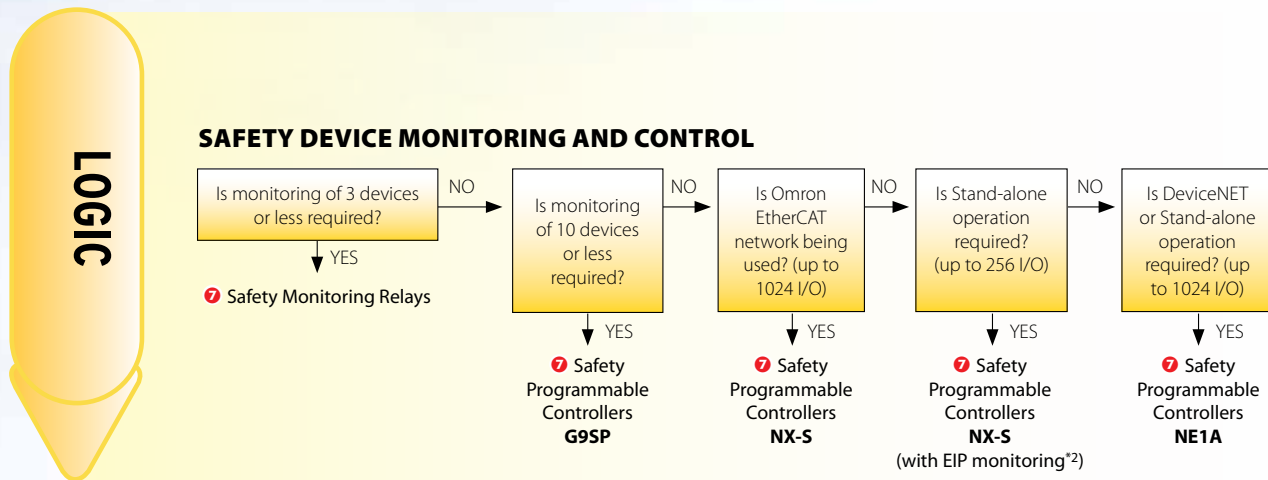
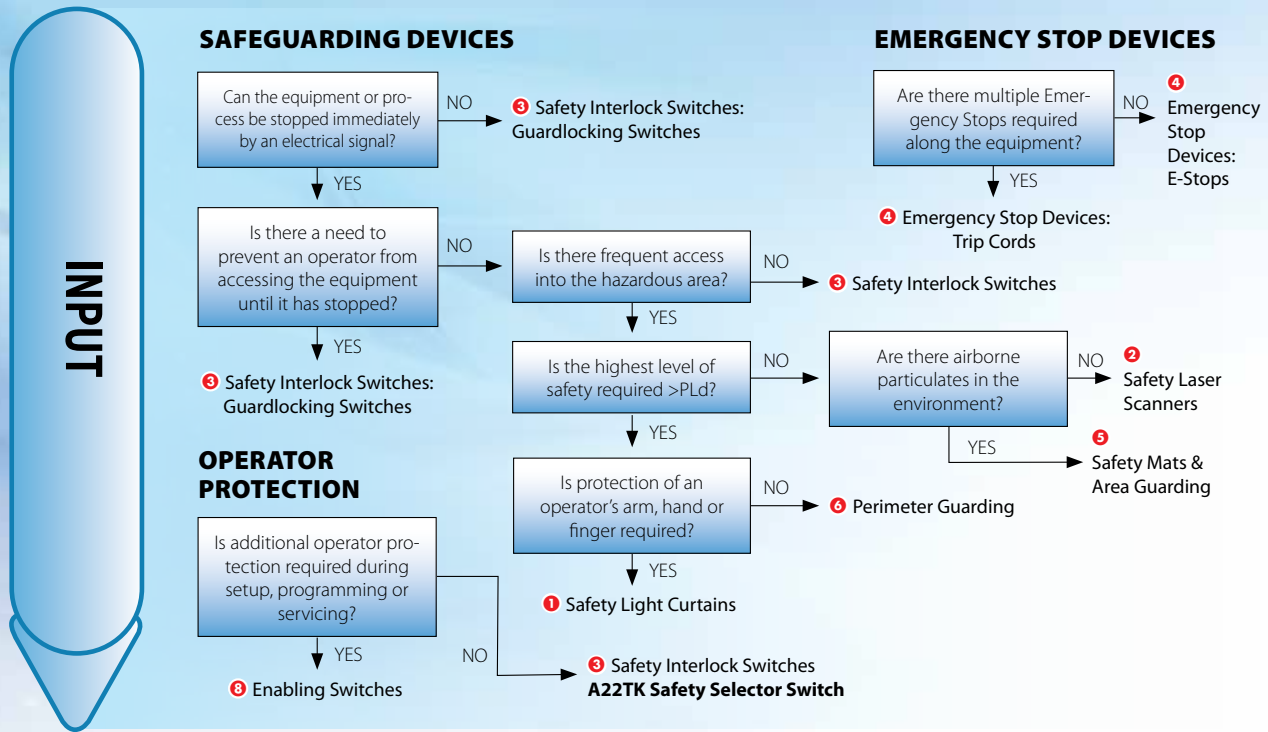

\*1 Please refer to [www.omron247.com](http://www.omron247.com) for more information about servos and drives with integrated safety

\*2 Available Early 2015

\* Please refer to [www.omron247.com](http://www.omron247.com) or to the Machine & Process Safeguarding Solution Selection Guide for additional information and product selections.

# Safety Light Curtains & Perimeter Access Guarding

## Contents

<b>Type 4 Light Curtains</b>		
F3SG-RA	Global Light Curtain	AA-2
MS4800 MSF4800	MiniSafe® Light Curtain	AA-3
F3SJ-A	“Advanced” Light Curtain	AA-4
F3SJ-B	“Basic” Light Curtain	AA-5
F3SJ-E	“Easy” Light Curtain	AA-6
<b>Light Curtain Resource Modules</b>		
RM-1	Resource Module Converts Solid-State Outputs to Force-Guided Relay Outputs	AA-7
RM-2, -2AC, -2-AC-IP	Resource Module – Converts Solid-State Outputs to Force-Guided Relay Outputs	AA-7
RM-3	Resource Module – Mute Module	AA-8
RM-X	Resource Module – Converts Solid-State Outputs to Force-Guided Relay Outputs	AA-8
<b>Perimeter Access Guarding</b>		
PA4600	Perimeter Access Guarding Device	AA-9

## Global Multilingual Light Curtain offers safety in 8 languages

Advanced Safety Light Curtain in rugged, IP67 rates housing

- Built-in muting; requires no external muting controller
- Resolution: 14 mm (finger protection) and 30 mm (Hand protection) models
- Scan QR code with smart phone for local language support and troubleshooting guide
- All models designed for global use; PNP/ NPN output selection DIP switch



## Ordering Information

Model	Description
F3SG-4RA0240-14	F3SG-4RA, 14MM RESOLUTION, 240 PROTECTIVE HEIGHT
F3SG-4RA0400-14	F3SG-4RA, 14MM RESOLUTION, 400 PROTECTIVE HEIGHT
F3SG-4RA0560-14	F3SG-4RA, 14MM RESOLUTION, 560 PROTECTIVE HEIGHT
F3SG-4RA0720-14	F3SG-4RA, 14MM RESOLUTION, 720 PROTECTIVE HEIGHT
F3SG-4RA0880-14	F3SG-4RA, 14MM RESOLUTION, 880 PROTECTIVE HEIGHT
F3SG-4RA1200-14	F3SG-4RA, 14MM RESOLUTION, 1200 PROTECTIVE HEIGHT
F3SG-4RA1680-14	F3SG-4RA, 14MM RESOLUTION, 1680 PROTECTIVE HEIGHT
F3SG-4RA0270-30	F3SG-4RA, 30MM RESOLUTION, 270 PROTECTIVE HEIGHT
F3SG-4RA0430-30	F3SG-4RA, 30MM RESOLUTION, 430 PROTECTIVE HEIGHT
F3SG-4RA0590-30	F3SG-4RA, 30MM RESOLUTION, 590 PROTECTIVE HEIGHT
F3SG-4RA0750-30	F3SG-4RA, 30MM RESOLUTION, 750 PROTECTIVE HEIGHT
F3SG-4RA0910-30	F3SG-4RA, 30MM RESOLUTION, 910 PROTECTIVE HEIGHT
F3SG-4RA1230-30	F3SG-4RA, 30MM RESOLUTION, 1230 PROTECTIVE HEIGHT
F3SG-4RA1550-30	F3SG-4RA, 30MM RESOLUTION, 1550 PROTECTIVE HEIGHT
F3SG-4RA1790-30	F3SG-4RA, 30MM RESOLUTION, 1790 PROTECTIVE HEIGHT
F39-LGA	F3SG-4RA STANDARD ADJUSTABLE BRACKET
F39-LP	F3SG-4RA MUTING LAMP
F39-JG10A-L	F3SG-4RA, SINGLE ENDED CABLE FOR TX,10M
F39-JG3B-L	F3SG-4RA, DOUBLE ENDED CABLE FOR TX,3M
F39-JG7B-L	F3SG-4RA, DOUBLE ENDED CABLE FOR TX,7M
F39-JG10B-L	F3SG-4RA, DOUBLE ENDED CABLE FOR TX,10M
F39-JG10A-D	F3SG-4RA, SINGLE ENDED CABLE FOR RX,10M
F39-JG3B-D	F3SG-4RA, DOUBLE ENDED CABLE FOR RX,3M
F39-JG5B-D	F3SG-4RA, DOUBLE ENDED CABLE FOR RX,5M
F39-JG10B-D	F3SG-4RA, DOUBLE ENDED CABLE FOR RX,10M

## MiniSafe® Light Curtains

- Resolutions: 14 mm (0.55 in.), 20 mm (0.79 in.), 30 mm (1.18 in.), and 40 mm (1.57 in.)
- Ranges: 7 m (23 ft.) for 14 mm resolution systems; and 20 m (65 ft.) for 20, 30 and 40 mm resolution systems
- Protected Heights: 280 to 2120 mm (11 to 83.5 in.)
- Compact size: 50 x 38 mm (2 x 1.5 in.)
- “Two-box” design — no separate control box; no cable between transmitter and receiver
- Individual Beam Indicators
- Quick and easy fixed blanking programming option “SB1”
- Simple cascading models



## Ordering Information

Model	Part Number	Description
MS4800S-20-0320	70230-1180	MS4800 SYSTEM, STANDARD, 20MM RESOLUTION, 320 PROTECTED HEIGHT
MS4800S-20-0440	70230-1183	MS4800 SYSTEM, STANDARD, 20MM RESOLUTION, 440 PROTECTED HEIGHT
MS4800S-20-0600	70230-1187	MS4800 SYSTEM, STANDARD, 20MM RESOLUTION, 600 PROTECTED HEIGHT
MS4800S-20-0760	70230-1191	MS4800 SYSTEM, STANDARD, 20MM RESOLUTION, 760 PROTECTED HEIGHT
MS4800S-20-0920	70230-1195	MS4800 SYSTEM, STANDARD, 20MM RESOLUTION, 920 PROTECTED HEIGHT
MS4800S-20-1080	70230-1199	MS4800 SYSTEM, STANDARD, 20MM RESOLUTION, 1080 PROTECTED HEIGHT
MS4800S-20-1200	70230-1202	MS4800 SYSTEM, STANDARD, 20MM RESOLUTION, 1200 PROTECTED HEIGHT
MS4800S-30-0440	70230-1222	MS4800 SYSTEM, STANDARD, 30MM RESOLUTION, 440 PROTECTED HEIGHT
MS4800S-30-0600	70230-1226	MS4800 SYSTEM, STANDARD, 30MM RESOLUTION, 600 PROTECTED HEIGHT
MS4800S-30-0720	70230-1229	MS4800 SYSTEM, STANDARD, 30MM RESOLUTION, 720 PROTECTED HEIGHT
MS4800S-30-0760	70230-1230	MS4800 SYSTEM, STANDARD, 30MM RESOLUTION, 760 PROTECTED HEIGHT
MS4800S-30-0840	70230-1232	MS4800 SYSTEM, STANDARD, 30MM RESOLUTION, 840 PROTECTED HEIGHT
MS4800S-30-0920	70230-1234	MS4800 SYSTEM, STANDARD, 30MM RESOLUTION, 920 PROTECTED HEIGHT
MS4800S-30-1040	70230-1237	MS4800 SYSTEM, STANDARD, 30MM RESOLUTION, 1040 PROTECTED HEIGHT
MS4800S-30-1200	70230-1241	MS4800 SYSTEM, STANDARD, 30MM RESOLUTION, 1200 PROTECTED HEIGHT
MS4800S-30-1400	70230-1246	MS4800 SYSTEM, STANDARD, 30MM RESOLUTION, 1400 PROTECTED HEIGHT
MS4800S-30-1520	70230-1249	MS4800 SYSTEM, STANDARD, 30MM RESOLUTION, 1520 PROTECTED HEIGHT
MS4800-CBLRX-10M	40451-0100	MS4800 SPARE RECEIVER CABLE, 10M
MS4800-CBLRX-15M	40451-0150	MS4800 SPARE RECEIVER CABLE, 15M
MS4800-CBLRX-30M	40451-0300	MS4800 SPARE RECEIVER CABLE, 30M
MS4800-CBLTX-10M	40452-0100	MS4800 SPARE TRANSMITTER CABLE, 10M
MS4800-CBLTX-15M	40452-0150	MS4800 SPARE TRANSMITTER CABLE, 15M
MS4800-CBLTX-30M	40452-0300	MS4800 SPARE TRANSMITTER CABLE, 30M

A  
A

## “Advanced” Safety Light Curtains

- Resolution: 14 mm (0.55 in.), 20 mm (0.79 in.), 25 mm (1.01 in.) 30 mm (1.18 in.), or 55 mm (2.17 in.)
- Range: 7 m (23 ft.) or 9 m (29.5 ft.) dependent on minimum object resolution and protected height
- Protected heights: 14 mm protected heights from 245 to 1631 mm (9.6 to 64 in.), 20 mm, 25 mm and 30 mm protected heights from 245 to 2495 mm (9.6 to 98 in.), 55 mm from 270 to 2470 mm (10.6 to 97 in.)
- Very compact size – 30 x 24 mm (1.18 x 0.94 in.)
- Cascaded designs possible – 4 segments, up to 400 beams
- Partial muting and position detection muting
- Cross-talk prevention



## Ordering Information

Model	Part Number	Description
F3SJ-A0245P20	40560-2001	F3SJ-A SYSTEM, 20MM RESOLUTION, 245 PROTECTIVE HEIGHT
F3SJ-A0245P30	40560-3001	F3SJ-A SYSTEM, 30MM RESOLUTION, 245 PROTECTIVE HEIGHT
F3SJ-A0305P20	40560-2003	F3SJ-A SYSTEM, 20MM RESOLUTION, 305 PROTECTIVE HEIGHT
F3SJ-A0320P30	40560-3004	F3SJ-A SYSTEM, 30MM RESOLUTION, 320 PROTECTIVE HEIGHT
F3SJ-A0395P30	40560-3007	F3SJ-A SYSTEM, 30MM RESOLUTION, 395 PROTECTIVE HEIGHT
F3SJ-A0455P20	40560-2008	F3SJ-A SYSTEM, 20MM RESOLUTION, 455 PROTECTIVE HEIGHT
F3SJ-A0470P30	40560-3010	F3SJ-A SYSTEM, 30MM RESOLUTION, 470 PROTECTIVE HEIGHT
F3SJ-A0605P20	40560-2013	F3SJ-A SYSTEM, 20MM RESOLUTION, 605 PROTECTIVE HEIGHT
F3SJ-A0620P30	40560-3016	F3SJ-A SYSTEM, 30MM RESOLUTION, 620 PROTECTIVE HEIGHT
F3SJ-A0695P30	40560-3019	F3SJ-A SYSTEM, 30MM RESOLUTION, 695 PROTECTIVE HEIGHT
F3SJ-A0755P20	40560-2018	F3SJ-A SYSTEM, 20MM RESOLUTION, 755 PROTECTIVE HEIGHT
F3SJ-A0770P30	40560-3022	F3SJ-A SYSTEM, 30MM RESOLUTION, 770 PROTECTIVE HEIGHT
F3SJ-A0870P30	40560-3026	F3SJ-A SYSTEM, 30MM RESOLUTION, 870 PROTECTIVE HEIGHT
F3SJ-A0905P20	40560-2023	F3SJ-A SYSTEM, 20MM RESOLUTION, 905 PROTECTIVE HEIGHT
F3SJ-A0920P30	40560-3028	F3SJ-A SYSTEM, 30MM RESOLUTION, 920 PROTECTIVE HEIGHT
F3SJ-A1025P20	40560-2027	F3SJ-A SYSTEM, 20MM RESOLUTION, 1025 PROTECTIVE HEIGHT
F3SJ-A1045P30	40560-3033	F3SJ-A SYSTEM, 30MM RESOLUTION, 1045 PROTECTIVE HEIGHT
F3SJ-A1220P30	40560-3040	F3SJ-A SYSTEM, 30MM RESOLUTION, 1220 PROTECTIVE HEIGHT
F3SJ-A1495P30	40560-3045	F3SJ-A SYSTEM, 30MM RESOLUTION, 1495 PROTECTIVE HEIGHT
F39-CN6	11033-0007	F3SJ-A KEY CAP FOR MUTING
F39-LJ1	11033-0008	F3SJ-A MOUNTING BRACKETS, STANDARD MOUNTING
F39-LJ2	11033-0009	F3SJ-A MOUNTING BRACKETS, FLAT SIDE MOUNTING
F39-LJ3	11033-0010	F3SJ-A MOUNTING BRACKETS, FREE-LOCATION MOUNTING
F39-GWUM	11033-0155	F3SJ-A SD-MANAGER SETTING SUPPORT SOFTWARE
F39-TC5P01	11033-0180	F3SJ-A CONNECTOR TERMINAL BOX WITH MUTING SENSOR OUTPUT MODE (PNP)
F39-TC5P02	11033-0181	F3SJ-A CONNECTOR TERMINAL BOX WITH OVERRIDE MODE (PNP)
F39-CN8	11033-0184	F3SJ-A SHORT-CIRCUIT CONNECTOR
F39-JC3A	11034-1001	F3SJ-A CONNECTOR CABLE, SINGLE-ENDED, 3M, PAIR
F39-JC7A	11034-1002	F3SJ-A CONNECTOR CABLE, SINGLE-ENDED, 7M, PAIR
F39-JC10A	11034-1003	F3SJ-A CONNECTOR CABLE, SINGLE-ENDED, 10M, PAIR
F39-JC15A	11034-1004	F3SJ-A CONNECTOR CABLE, SINGLE-ENDED, 15M, PAIR
F39-JC20A	11034-1071	F3SJ-A CONNECTOR CABLE, SINGLE-ENDED, 20M, PAIR
F3SP-B1P	11042-6001	F3SJ-A/B CONTROL UNIT



## “Basic” Safety Light Curtains

- Fast and easy installation
- Resolution: 25 mm (1.01 in.)
- Range: 7 m (23 ft.)
- Protected heights: 185 to 2065 mm (7.28 to 81.26 in.)
- Very compact size: 30 x 30 mm (1.18 x 1.18 in.)
- Cascaded designs possible – 3 segments
- Simple muting
- Cross-talk prevention



## Ordering Information

Model	Part Number	Description
F3SJ-B0185P25	11037-7001	F3SJ-B SYSTEM, 25MM RESOLUTION, 185 MM PROTECTED HEIGHT
F3SJ-B0305P25	11037-7003	F3SJ-B SYSTEM, 25MM RESOLUTION, 305 MM PROTECTED HEIGHT
F3SJ-B0465P25	11037-7005	F3SJ-B SYSTEM, 25MM RESOLUTION, 465 MM PROTECTED HEIGHT
F3SJ-B0625P25	11037-7007	F3SJ-B SYSTEM, 25MM RESOLUTION, 625 MM PROTECTED HEIGHT
F3SJ-B0785P25	11037-7009	F3SJ-B SYSTEM, 25MM RESOLUTION, 785 MM PROTECTED HEIGHT
F3SJ-B0945P25	11037-7011	F3SJ-B SYSTEM, 25MM RESOLUTION, 945 MM PROTECTED HEIGHT
F3SJ-B1105P25	11037-7013	F3SJ-B SYSTEM, 25MM RESOLUTION, 1105 MM PROTECTED HEIGHT
F3SJ-B1265P25	11037-0015	F3SJ-B SYSTEM, 25MM RESOLUTION, 1265 MM PROTECTED HEIGHT
F3SJ-B1505P25	11037-0018	F3SJ-B SYSTEM, 25MM RESOLUTION, 1505 MM PROTECTED HEIGHT
F3SP-B1P	11042-6001	F3SJ-A/B CONTROL UNIT
F39-JD3A	11077-1003	F3SJ-B CONNECTOR CABLE, SINGLE-ENDED, 3M, PAIR
F39-JD7A	11077-1004	F3SJ-B CONNECTOR CABLE, SINGLE-ENDED, 7M, PAIR
F39-JD10A	11077-1005	F3SJ-B CONNECTOR CABLE, SINGLE-ENDED, 10M, PAIR
F39-JD15A	11077-1006	F3SJ-B CONNECTOR CABLE, SINGLE-ENDED, 15M, PAIR
F39-JD20A	11077-1007	F3SJ-B CONNECTOR CABLE, SINGLE-ENDED, 20M, PAIR
F39-JDR5B	11077-1008	F3SJ-B CONNECTOR CABLE, DOUBLE-ENDED, 0.5M, PAIR
F39-JD1B	11077-1009	F3SJ-B CONNECTOR CABLE, DOUBLE-ENDED, 1M, PAIR
F39-JD3B	11077-1010	F3SJ-B CONNECTOR CABLE, DOUBLE-ENDED, 3M, PAIR
F39-JD5B	11077-1011	F3SJ-B CONNECTOR CABLE, DOUBLE-ENDED, 5M, PAIR
F39-JD7B	11077-1012	F3SJ-B CONNECTOR CABLE, DOUBLE-ENDED, 7M, PAIR
F39-JD10B	11077-1013	F3SJ-B CONNECTOR CABLE, DOUBLE-ENDED, 10M, PAIR
F39-JD15B	11077-1014	F3SJ-B CONNECTOR CABLE, DOUBLE-ENDED, 15M, PAIR
F39-JD20B	11077-1015	F3SJ-B CONNECTOR CABLE, DOUBLE-ENDED, 20M, PAIR
F39-LJB1	11083-0001	F3SJ-E/B TOP/BOTTOM BRACKET, INCLUDES 4 PCS
F39-LJB4	11083-0007	F3SJ-E/B COMPATIBLE MOUNTING BRACKET, USE WHEN REPLACING F3SJ-A OR F3SN, INCLUDES 4 PCS
F39-CN10	11083-1001	F3SJ-B MUTING KEY CAP
F39-JBR2W	11083-1002	F3SJ-B CONNECTION CABLE FOR EXTENSION, 0.2M

A  
A

## “Easy” Safety Light Curtains

- Fast and easy installation
- Resolution: 25 mm (1.01 in.)
- Range: 7 m (23 ft.)
- Protected heights: 185 to 1105 mm (7.28 to 43.50 in.)
- Very compact size: 30 x 30 mm (1.18 x 1.18 in.)
- Cross-talk prevention
- 3 m integrated cables



## Ordering Information

Model	Part Number	Description
F3SJ-E0185P25	11082-7001	F3SJ-E SYSTEM, 25MM RESOLUTION, 185 MM PROTECTED HEIGHT
F3SJ-E0305P25	11082-7003	F3SJ-E SYSTEM, 25MM RESOLUTION, 305 MM PROTECTED HEIGHT
F3SJ-E0465P25	11082-7005	F3SJ-E SYSTEM, 25MM RESOLUTION, 465 MM PROTECTED HEIGHT
F3SJ-E0625P25	11082-7007	F3SJ-E SYSTEM, 25MM RESOLUTION, 625 MM PROTECTED HEIGHT
F3SJ-E0785P25	11082-7009	F3SJ-E SYSTEM, 25MM RESOLUTION, 785 MM PROTECTED HEIGHT
F3SJ-E0945P25	11082-7011	F3SJ-E SYSTEM, 25MM RESOLUTION, 945 MM PROTECTED HEIGHT
F3SJ-E1105P25	11082-7013	F3SJ-E SYSTEM, 25MM RESOLUTION, 1105 MM PROTECTED HEIGHT
F39-LJB1	11083-0001	F3SJ-E/B TOP/BOTTOM BRACKET, INCLUDES 4 PCS
F39-LJB4	11083-0007	F3SJ-E/B COMPATIBLE MOUNTING BRACKET, USE WHEN REPLACING F3SJ-A OR F3SN, INCLUDES 4 PCS

## Resource Module — Converts Solid-State Outputs to Force-Guided Relay Outputs

- Converts the solid-state safety outputs of one STI safety device to electromechanical force-guided safety relay outputs
- Compatible with MS4800, F3SJ, PA4600 and OS32C
- 55 mm DIN enclosure with removable terminal blocks
- CE approved



### Ordering Information

Model	Part Number	Description
RM-1	43763-0010	RM-1, 24VDC, DIN-RAIL MOUNT

# RM-2, -2AC & 2-AC-IP Resource Module

## Resource Module — Converts Solid-State Outputs to Force-Guided Relay Outputs

- Converts the solid-state safety and auxiliary outputs of one STI safety device to electromechanical force-guided safety relay outputs
- Available for DC or AC input power
- Provides connection points for all safety device functions including MPCE monitoring and 24 VDC power
- Compatible with MS4800, F3SJ, PA4600 and OS32C
- Enclosures —  
 RM-2: 100 mm DIN, IP20  
 RM-2AC: 150 mm DIN, IP20  
 RM-2AC-IP: metal chassis, IP65



- CE approved
- Removable terminal blocks

### Ordering Information

Model	Part Number	Description
RM-2	43776-0010	RM-2, 24VDC, DIN-RAIL MOUNT
RM-2AC	40344-0010	RM-2AC, 100-240VAC, DIN-RAIL MOUNT
RM-2AC-IP	40525-0010	RM-2AC-IP, 100-240VAC, METAL CHASSIS



## Resource Module — Mute Module

- Type 4 safety product, when used in combination with a Type 4 safety light curtain
- Provides muting controls for up to two light curtains
- Diagnostic display
- Solid-state safety outputs
- 100 mm DIN box enclosure
- Removable terminal blocks
- DeviceNet option
- Compatible with MS4800, F3SJ, PA4600 and OS32C

### Input Signals

- Input Power +24 VDC
- Two independent channels, each channel is comprised of one light curtain and up to four mute sensors
- Start
- EDM (MPCE monitoring)
- Mute enable

### Output Signals

- Two independent PNP safety outputs
- NPN & PNP auxiliary outputs
- Mute lamp drivers (2)
- Mute auxiliary (NPN)
- Mute armed (NPN)



### Indicators

- Diagnostic display
- Machine Run
- Machine Stop
- Interlock
- OSSD input active (light curtains)
- Sensor input active (sensors)
- Mute Enable active

### Ordering Information

Model	Part Number	Description
RM-3	43983-0010	RM-3, MUTE MODULE, 24VDC, DIN-RAIL MOUNT

## Resource Module — Converts Solid-State Outputs to Force-Guided Relay Outputs

- Converts the solid-state safety outputs of one STI safety device to electromechanical force-guided safety relay outputs
- Compatible with MS4800, F3SJ, PA4600 and OS32C
- CE approved
- 22.5 mm DIN enclosure



### Ordering Information

Model	Part Number	Description
RM-X	40152-0010	RM-X, RELAY EXPANSION MODULE

## Perimeter Access Guarding Device

- 1 to 6 beams available
- Operating range of 70 m
- Compact size — 46 x 55 mm (1.81 x 2.17 in.)
- Simple “two-box” design — no separate control box required
- Individual Beam Indicators



## Ordering Information

Model	Part Number	Description
PA46-1-000-Q2-NO1-PN	70170-1045	PA4600 SYSTEM, 1 BEAM, M-12 QD, NO1, PNP
PA46-2-600-Q2-NO1-PN	70170-1042	PA4600 SYSTEM, 2 BEAMS, 600MM SPACING, QD, NO1, PNP
PA46-3-400-Q2-NO1-PN	70170-1039	PA4600 SYSTEM, 3 BEAMS, 400MM SPACING, QD, NO1, PNP
CBL-LCRX-10M	40552-0100	PA4600 RECEIVER CABLE, 10M
CBL-LCRX-15M	40552-0150	PA4600 RECEIVER CABLE, 15M
CBL-LCRX-30M	40552-0300	PA4600 RECEIVER CABLE, 30M
CBL-LCTX-10M	40553-0100	PA4600 TRANSMITTER CABLE, 10M
CBL-LCTX-15M	40553-0150	PA4600 TRANSMITTER CABLE, 15M
CBL-LCTX-30M	40553-0300	PA4600 TRANSMITTER CABLE, 30M

# Safety Light Curtains & Perimeter Access Guarding

---

## Contents

Safety Laser Scanner		
OS32C	Compact Area Safety Laser Scanner	BB-2

## Compact Safety Area Laser Scanner

EtherNet/IP Capable for Status and  
Measurement Data Reporting

- Compact size (104.5 mm height), power efficient (5 W) and light weight (1.3 kg) for longer AGV battery life
- Versions with 3M and 4M safety zones available
- Configuration memory block, no need to reprogram after sensor replacement, minimal down time
- Configurable minimum object resolution of 30, 40, 50 or 70 mm, for hand and arm detection applications
- 8 individual sector indicators and LED indicators, determine scanner status at a glance



**EtherNet/IP™**  
conformance tested



- Type 3 Safety Laser Scanner complies with IEC61496-1/-3
- Performance Level d and category 3 (ISO13849-1)

## Ordering Information

Model	Part Number	Description
OS32C-BP	40589-0011	SYSTEM WITH BACK CABLE ENTRY, ETHERNET, 3M
OS32C-BP-DM	40589-0013	SYSTEM WITH BACK CABLE ENTRY, ETHERNET/IP, 3M, MEASUREMENT
OS32C-SP1	40589-0021	SYSTEM WITH SIDE CABLE ENTRY, ETHERNET, 3M
OS32C-SP1-DM	40589-0023	SYSTEM WITH SIDE CABLE ENTRY, ETHERNET/IP, 3M, MEASUREMENT
OS32C-BP-4M	40588-0011	SYSTEM WITH BACK CABLE ENTRY, ETHERNET, 4M
OS32C-SP1-4M	40588-0021	SYSTEM WITH BACK CABLE ENTRY, ETHERNET, 4M
OS32C-BP-DM-4M	40588-0013	SYSTEM WITH BACK CABLE ENTRY, ETHERNET/IP, 4M, MEASUREMENT
OS32C-SP1-DM-4M	40588-0023	SYSTEM WITH BACK CABLE ENTRY, ETHERNET/IP, 4M, MEASUREMENT
WIN-CLN-KT	40387-0020	WINDOW CLEANING KIT
OS32C-BKT1	40634-0010	MOUNTING BRACKET, BOTTOM/SIDE
OS32C-BKT2	40635-0010	MOUNTING BRACKET, XY AXIS ROTATION
OS32C-BKT4	40636-0010	MOUNTING BRACKET, PROTECTIVE COVER FOR WINDOW
OS32C-MT	40637-0010	MOUNTING STAND
OS32C-HDT	40638-0010	MOUNTING STAND HARDWARE KIT
OS32C-BKT3	40648-0010	MOUNTING BRACKET, SIMPLE
OS32C-CBL-03M	40649-0030	POWER CABLE, 3M
OS32C-CBL-10M	40649-0100	POWER CABLE, 10M
OS32C-CBL-20M	40649-0200	POWER CABLE, 20M
OS32C-CBL-30M	40649-0300	POWER CABLE, 30M
OS32C-ECBL-02M	40650-0020	ETHERNET CABLE, 2M
OS32C-ECBL-05M	40650-0050	ETHERNET CABLE, 5M
OS32C-ECBL-15M	40650-0150	ETHERNET CABLE, 15M
OS32C-SN	40651-0011	SPARE I/O SENSOR BLOCK WITHOUT I/O BLOCK
OS32C-SN-DM	40651-0013	SPARE I/O SENSOR BLOCK WITHOUT I/O BLOCK FOR DM VERSION
OS32C-CBBP	40652-0010	SPARE I/O BLOCK WITH BACK CABLE ACCESS
OS32C-CBSP1	40652-0020	SPARE I/O BLOCK WITH LEFT SIDE CABLE ACCESS
OS32C-WIN-KT	40653-0010	SPARE REPLACEMENT SCAN WINDOW
OS32C-ADAPT-OS31	40668-0010	TO OS3101 ADAPTOR CABLE



## Contents

### Modular Safety System

NX-S	Safety Control and I/O	CC-1
------	------------------------	------

### Stand-Alone Safety Controller

G9SP	Programmable Safety Controller	CC-2
------	--------------------------------	------

### DeviceNet Safety

NE1A	Compact Safety Network Controllers	CC-3
------	---------------------------------------	------

DST1	Safety I/O Terminals	CC-4
------	----------------------	------

# Programmable Safety Controllers

---

## Safety over EtherCAT Integration of Safety into Machine Automation Enables Simple, Flexible System Configuration

- EN ISO13849-1 (PLe/Safety Category 4), IEC 61508 (SIL3) certified.
- One connection using Safety over EtherCAT (FSoE)\* protocol enables flexible configuration by mixing the Safety Units with standard NX I/O.
- Hardware and safety circuits can be configured using the Sysmac Studio



### Features

- Integrated safety into machine automation possible by connecting with the NX-series EtherCAT coupler.
- The Safety CPU Unit controls up to 128 Safety I/O Units.
- 4 or 8 points per Safety Input Unit. The 2-point Safety Input Unit can be directly connected with OMRON Non-contact Switches and Single beam Sensors.
- 2 or 4 points per Safety Output Unit. The 2-point Safety Output Unit is characterized by large output breaking current of 2.0 A.
- The Safety Units can be freely allocated in any combination with standard NX I/O.
- Compliant with IEC61131-3.
- NEW! Now available for use with the NX EtherNet/IP coupler for stand-alone operation with monitoring by any EtherNet/IP master device.

### Ordering Information

Model	Description
NX-SIH400 VER 1.1	NX SAFETY I/O, 4 IN, SPECIALTY
NX-SOD400	NX SAFETY I/O, 4 OUT, 0.5A
NX-SID800	NX SAFETY I/O, 8 IN, STANDARD
NX-SOH200	NX SAFETY I/O, 2 OUT, 2A
NX-SL3300 VER 1.1	CPU-512K, 32 SAFETY CONNECTIONS, 256 I/O MAX.
NX-SL3500	CPU-2048K, 128 SAFETY CONNECTIONS, 1024 I/O MAX.

\*Safety over EtherCAT (FSoE): The open protocol Safety over EtherCAT (abbreviated with FSoE “FailSafe over EtherCAT” defines a safety related communication layer for EtherCAT. Safety over EtherCAT meets the requirements of IEC 61508 SIL 3 and enables the transfer of safe and standard information on the same communication system without limitations with regard to transfer speed and cycle time.

Sysmac is a trademark or registered trademark of OMRON Corporation in Japan and other countries for OMRON factory automation products. EtherCAT® is a registered trademark of Beckhoff Automation GmbH for their patented technology.



## Compact Standalone Programmable Safety Controllers for small and mid-sized machinery

- Easy programming for complex safety control
- Three types of CPU with different I/O size to suit the application
- Four types of Expansion I/O Units for hard-wired diagnosis or standard non-safety signals
- Clear diagnosis and monitoring via Ethernet (Omron FINS protocol), EtherNet/IP, or serial (RS-232) connection
- Supports direct connection with non-contact switches and safety mats
- Easy design, verification, standardization and reuse of safety control by unique programming software
- ISO 13849-1(PLe), IEC61508(SIL3) certified



## Ordering Information

Model	Part Number	Description
CM-EIP-1	82611-0010	G9SP ETHERNET/IP OPTION BOARD
G9SP-N10D	11080-0002	G9SP BASE MODEL, CONTROLLER, 10 SAFETY INPUTS, 6 TEST OUTPUTS, 16 SAFETY OUTPUTS
G9SP-N10S	11080-0001	G9SP BASE MODEL, CONTROLLER, 10 SAFETY INPUTS, 4 TEST OUTPUTS, 4 SAFETY OUTPUTS
G9SP-N20S	11080-0003	G9SP BASE MODEL, CONTROLLER, 20 SAFETY INPUTS, 6 TEST OUTPUTS, 8 SAFETY OUTPUTS
WS02-G9SP01-V1	11080-1001	G9SP SOFTWARE CONFIGURATOR

## DeviceNet Safety Network Controllers

- NE1A Series helps to reduce wiring within a safety network and delivers a high degree of flexibility.
- NE1A-SCPU01-V1 provides 16 built-in safety inputs and 8 built-in safety outputs.
- NE1A-SCPU02 provides 40 built-in safety inputs and 8 built-in safety outputs.
- For lines with various levels of distributed safety devices up to 64 controllers can be connected to the network.
- Complicated safety systems are greatly simplified with 23 safety-certified function blocks and easy Drag and drop hardware configuration.
- Monitor the safety system from standard controllers across the network.
- EN 954-1/ISO13849-1 CAT4 and IEC 61508 SIL3 certification.



## Ordering Information

Model	Part Number	Description
NE1A-SCPU01-V1 VER 2.0	11061-0004	NE1A BASE MODEL, 16 INPUTS, 8 OUTPUTS
NE1A-SCPU02 VER 2.0	11061-0005	NE1A BASE MODEL, 40 INPUTS, 8 OUTPUTS

## Distributed Safety I/O Terminals that reduce wiring

- Distributed safety terminals that reduce wiring
- Lineup includes four models to accommodate various I/O types and number of I/O points
- Monitor the safety system from standard controllers across the network
- EN 954-1/ISO13849-1 CAT4 and IEC 61508 SIL3 certification
- The DST1-XD0808SL-1 supports logic operation functions for high-speed processing in applications requiring partial stopping of the safety system.



## Ordering Information

Model	Part Number	Description
DST1-ID12SL-1	11062-6001	DST1 BASE MODEL, 12 SAFETY INPUTS, 4 TEST OUTPUTS
DST1-MD16SL-1	11062-6002	DST1 BASE MODEL, 8 SAFETY INPUTS, 8 SAFETY OUTPUTS, 4 TEST OUTPUTS
DST1-MRD08SL-1	11062-6003	DST1 BASE MODEL, 4 SAFETY INPUTS, 4 SAFETY OUTPUTS, 4 TEST OUTPUTS

## Contents

Safety Mats		
UMQ	Quick-disconnect Universal Safety Mat	DD-1
MC	Safety Mat Controllers	DD-2
Safety Edges & Bumpers		
SGE & SCS	Safety Edges	DD-3
SCSF	Safety Bumpers	DD-3
SCC	Safety Edge Controllers	DD-4

D  
D

# Safety Mats, Edges & Bumpers

---



## Quick-Disconnect Universal Safety Mat System

Heavy-Duty Four-Wire Presence Sensing Mats with Removable Cable, Category 3 Controllers and Perimeter Trim

### System

When UMQ series mats are combined with an MC3, MC4 or MC6 controller (with complete diagnostics), the result is a system that meets the standard EN 1760-1:1998 and is entitled to display the CE mark. See below for an overview of the various components.

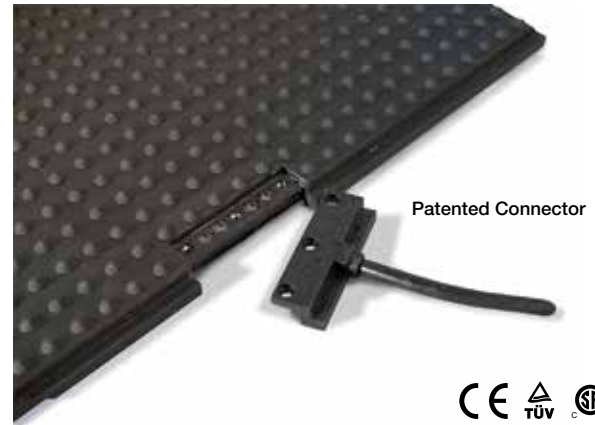

D  
D

### Ordering Information

Other custom sizes and configurations available.  
Please use the Quick Link code above for ordering information.

Model	Part Number	Description
UMQ-1260-A	70220-1002	UMQ UNIVERSAL BLACK MAT - 12 X 60 IN
UMQ-1872-A	70220-1010	UMQ UNIVERSAL BLACK MAT - 18 X 72 IN
UMQ-2412-A	70220-1011	UMQ UNIVERSAL BLACK MAT - 24 X 12 IN
UMQ-2418-A	70220-1012	UMQ UNIVERSAL BLACK MAT - 24 X 18 IN
UMQ-2424-A	70220-1013	UMQ UNIVERSAL BLACK MAT - 24 X 24 IN
UMQ-2460-A	70220-1015	UMQ UNIVERSAL BLACK MAT - 24 X 60 IN
UMQ-2472-A	70220-1017	UMQ UNIVERSAL BLACK MAT - 24 X 72 IN
UMQ-3030-A	70220-1021	UMQ UNIVERSAL BLACK MAT - 30 X 30 IN
UMQ-3060-A	70220-1023	UMQ UNIVERSAL BLACK MAT - 30 X 60 IN
UMQ-3072-A	70220-1025	UMQ UNIVERSAL BLACK MAT - 30 X 72 IN
UMQ-3612-A	70220-1026	UMQ UNIVERSAL BLACK MAT - 36 X 12 IN
UMQ-3624-A	70220-1028	UMQ UNIVERSAL BLACK MAT - 36 X 24 IN
UMQ-3636-A	70220-1030	UMQ UNIVERSAL BLACK MAT - 36 X 36 IN
UMQ-3654-A	70220-1031	UMQ UNIVERSAL BLACK MAT - 36 X 54 IN
UMQ-3660-A	70220-1032	UMQ UNIVERSAL BLACK MAT - 36 X 60 IN
UMQ-3672-A	70220-1034	UMQ UNIVERSAL BLACK MAT - 36 X 72 IN
UMQ-4224-A	70220-1037	UMQ UNIVERSAL BLACK MAT - 42 X 24 IN
UMQ-4236-A	70220-1039	UMQ UNIVERSAL BLACK MAT - 42 X 36 IN
UMQ-4254-A	70220-1041	UMQ UNIVERSAL BLACK MAT - 42 X 54 IN
UMQ-4260-A	70220-1042	UMQ UNIVERSAL BLACK MAT - 42 X 60 IN
UMQ-4824-A	70220-1047	UMQ UNIVERSAL BLACK MAT - 48 X 24 IN
UMQ-4836-A	70220-1049	UMQ UNIVERSAL BLACK MAT - 48 X 36 IN
UMQ-4848-A	70220-1051	UMQ UNIVERSAL BLACK MAT - 48 X 48 IN
UMQ-4866-A	70220-1054	UMQ UNIVERSAL BLACK MAT - 48 X 66 IN
UMQ-4872-A	70220-1055	UMQ UNIVERSAL BLACK MAT - 48 X 72 IN
UMQ5 CABLE	19251-0050	5M QUICK-DISCONNECT CABLE
UMQ10 CABLE	19251-0100	10M QUICK-DISCONNECT CABLE

### MC3, MC4 and MC6 Series Safety Mat Controllers

The MC Series safety mat controllers are used in conjunction with a four-wire, normally open, safety mat where perimeter guarding is required. These control reliable controllers send a stop signal to the guarded machine when an object of sufficient weight is detected on the active mat area.

The MC Series controllers, when combined with a four-wire UM or UMQ series mat, provide access guarding and improved productivity. The work area is fully visible and accessible.

The controller meets the requirement of EN 1760-1:1998, EN 13849-1, ANSI/RIA 15.06-1999 (R2009), ANSI B11.19-2010, OSHA 1910-217C. CSA and UL508.



#### MC6

- Universal power input
- Up to 6 mat zone inputs
- Six mat zone status indicator LEDs
- Select from Automatic Start, Start/Restart Interlock or Start Interlock operating modes
- MPCE monitoring

- Remote access to reset functions
- 2-digit numeric display for fault diagnostics
- Surface mount, lockable metal enclosure

#### Options

- Lid-mounted reset key switch
- Quick disconnect for incoming power and relay outputs
- Quick disconnects up to 6 mat zone inputs
- Solid-state safety output module
- Safety relay output module

### Ordering Information

Model	Part Number	Description
MC3	43767-0010	MC3 MAT CONTROLLER
MC4-0004	43815-0004	MC4 MAT CONTROLLER, 24VDC, 4 CONNECTORS
MC4-0010	43815-0010	MC4 MAT CONTROLLER, 100-240VAC, 0 CONNECTORS
MC4-0011	43815-0011	MC4 MAT CONTROLLER, 100-240VAC, 1 CONNECTOR
MC4-0012	43815-0012	MC4 MAT CONTROLLER, 100-240VAC, 2 CONNECTORS
MC4-0013	43815-0013	MC4 MAT CONTROLLER, 100-240VAC, 3 CONNECTORS
MC4-0014	43815-0014	MC4 MAT CONTROLLER, 100-240VAC, 4 CONNECTORS
MC6AC-0016	43938-0016	MC6 MAT CONTROLLER, AC 6 CONNECTORS
MC6DC-0012	43939-0012	MC6 MAT CONTROLLER, DC, 2 CONNECTORS
MC6DC-0016	43939-0016	MC6 MAT CONTROLLER, DC, 6 CONNECTORS

# SGE & SCS Series Safety Edges

Quick Link

S824

omron247.com

## Safety Edges (SGE & SCS Series Profiles)

- Profile materials NBR (SCS series only), EPDM or TPE
- Available in six sizes for SGE Series and two sizes for SCS Series

## Applicable Controllers

- SCC-1224 Single-Channel Controller
- SCC-1224ND Single-Channel Controller
- SCC-2124 Dual-Channel Controller
- SCC-2224 Dual-Channel Controller

## Ordering Information

All edges are custom. Please use the Quick Link code above for ordering information.



DD

# SCSF Safety Bumpers

Quick Link

S826

omron247.com

## Safety Bumpers

- Foam rubber covered in polyurethane, mounted on an aluminum base
- Available in lengths up to 3000 mm;  
Standard sizes:  
53 mm x 100 mm  
100 mm x 200 mm  
150 mm x 300 mm  
200 mm x 400 mm

## Ordering Information

All edges are custom. Please use the Quick Link code above for ordering information.



## Single and Dual-Channel Safety Edge Controllers

for use with All Safety Edges and Safety Bumpers

- Power requirements
  - 120 VAC or 24 VDC is acceptable for the SCC-1224 single channel units
  - 24 VDC is acceptable for SCC-2124/2224 dual channel units
- Inputs
  - Single channel units accept a single two-wire edge or bumper system
  - Dual channel units accept 1 or 2 two-wire edge or bumper systems
- Outputs
  - Single channel units have two safety outputs and one auxiliary output for signaling
  - Dual channel units have either 1 or 2 safety outputs, and either 1 or 2 auxiliary outputs with DIP switch selection for input channel relationship
- External Device Monitoring –EDM is provided on all units with a N/C loop between Z1 and Z2



- Monitored Reset Modes
  - Monitored manual reset mode that requires closure of the reset circuit followed by opening of the circuit is available on all units
  - Automatic reset mode that occurs upon closure of the reset circuit is available on all units
- Delayed Auxiliary Output – Delayed opening of the auxiliary output for reversal of a door or gate may be selected on all units except SCC1224ND

## Ordering Information

Model	Part Number	Description
SCC-1224	43872-0020	SCS EDGE CONTROLLER, AUX CONTACT MOMENTARILY CLOSES WHEN ACTIVATED
SCC-1224ND	43872-0021	SCS EDGE CONTROLLER, AUX CONTACT REMAINS CLOSED WHEN ACTIVATED

## Contents

<b>Tongue Interlock Switches</b>		
D4NS	Safety-Door Switch	EE-2
T5009 & T5009-6	Universal Tongue-Operated Safety Interlock Switch	EE-3
T4012	Universal Tongue-Operated Safety Interlock Switch	EE-4
T4016	Heavy-Duty Metal-Body Safety Interlock Switch	EE-5
T2008	Small Tongue-Operated Safety Interlock Switch	EE-6
D4GS-N	Slim Safety Door Switches with IP67 Rating	EE-7
<b>Guardlocking Interlock Switches</b>		
D4SL-N	Super Small Class 6-Contact Guard Lock Safety-Door Switch	EE-8
D4NL	Guard Lock Safety-Door Switch	EE-9
TL4019	Guard Lock Safety-Door Switch	EE-10
TL4024	Guard Lock Safety-Door Switch	EE-11
D4JL	Guard Lock Safety-Door Switch	EE-12
<b>Non-Contact Interlock Switches</b>		
CM	Most Diverse and Flexible Line of Coded Magnetic Safety Interlock Switches and Controllers	EE-13
MA	Magnetically Actuated Safety Interlock Switches	EE-14
D40Z/ D40A/ G9SX-NS	Compact Non-contact Door Switch/Flexible Safety Unit	EE-15
MA-S	Stainless Steel Magnetically Actuated Safety Interlock Switches and Actuators	EE-16
MFS	Stainless Steel Magnetically Actuated Safety Interlock Switches and Actuators	EE-17
<b>Hinge Pin Interlock Switches</b>		
D4NH	Safety-door Hinge Switch	EE-18

## Safety-Door Switch

- Multi-contact, labor-saving, environment-friendly, next-generation safety-door switch
- Lineup includes three contact models with 2NC/1NO and 3NC contact forms and MBB models in addition to the previous contact forms 1NC/1NO, and 2NC
- M12-connector models are available, saving on labor and simplifying replacement.
- Standardized gold-clad contacts provide high contact reliability. Applicable to both standard loads and microloads.
- Variety of metallic heads available



## Ordering Information

Model	Part Number	Description
D4NS-4CF-NPT	11027-0098	D4NS BASE MODEL, 2NC+1NO, M20+NPT
D4NS-4DF-NPT	11027-0099	D4NS BASE MODEL, 3NC, M20+NPT
D4NS-4BF-NPT	11027-0101	D4NS BASE MODEL, 2NC, M20+NPT
D4NS-4AF-NPT	11027-0104	D4NS BASE MODEL, 1NC+1NO, M20+NPT
D4DS-K1	11018-0011	D4NS, D4NL OPERATION KEY, HORIZONTAL MOUNTING
D4DS-K2	11018-0012	D4NS, D4NL OPERATION KEY, VERTICAL MOUNTING
D4DS-K3	11018-0013	D4NS, D4NL OPERATION KEY, ADJUSTABLE MOUNTING (HORIZONTAL)
D4DS-K5	11018-1005	D4NS, D4NL OPERATION KEY, ADJUSTABLE MOUNTING (HORIZONTAL/VERTICAL)

## Universal Tongue-Operated Safety Interlock Switch

- Strong and versatile—the compact size of the strong, glass-filled polyester housing and metal reinforced cam allows this popular switch to be used in most applications
- NEMA 6 enclosure enables these switches to withstand water washdown cleaning
- Rotatable head gives four possible actuator entry points for versatile installation. A blanking plug is supplied for the unused entry
- Small swing radius allows use on doors with a swing radius as small as 2.5 in. when using the optional flexible actuators
- Hi-Hold models reduce nuisance rips and allow the switch to also serve as the gate catch without the need to mount any additional hardware
- 4 contact poles provide 2 poles for dual channel safety monitoring and 2 additional poles for status monitoring



HI-HOLD MODELS AVAILABLE



Conforms to EN1088, EN292, EN60947-5-1, EN60204-1  
UL and C-UL listed

- Optional connector makes installation easy
- Optional stainless steel head is available

## Ordering Information

Model	Part Number	Description
T5009-021F1M	44501-0120	T5009 BASE MODEL, FLX1 2N/C+1NO BBM, 3 X M20/NPT
T5009-021SM	44501-0110	T5009 BASE MODEL, 2NC+1NO BBM, STD ACTUATOR, 3 X M20/NPT
T5009-6040N	44501-1045	T5009-6 BASE MODEL, 4NC BBM, 3 X 1/2 NPT
SM01-MCK40	44501-0740	T5009 CATCH KIT
SA01-S	44501-0750	T5009 REPLACEMENT STANDARD ACTUATOR
SA01-STD	44501-0755	T5009 STANDARD SPARE ACTUATOR, PLASTIC HEADED SWITCHES
SA01-FLX1	44501-0760	T5009 FLEX 1 SPARE ACTUATOR, PLASTIC OR STAINLESS STEEL HEADED SWITCHES
SA01-FLX2	44501-0765	T5009 FLEX 2 SPARE ACTUATOR, PLASTIC OR STAINLESS STEEL HEADED SWITCHES
SA01-F2	44501-0780	T5009, T5007 REPLACEMENT FLEXIBLE 2 ACTUATOR WITH GUIDE
SA19-F1	44519-0710	T5009, TL8012, TL5012, T5007, T4011 REPLACEMENT FLEXIBLE ACTUATOR WITH GUIDE
SLD26-01	44526-0801	T5009, T4011, T5007, TL8012-S SWITCH LOCKING DEVICE

## Universal Tongue-Operated Safety Interlock Switch

- Strong and versatile—the compact size of the strong, glass-filled thermoplastic housing allows this switch to be used in most applications
- NEMA 6 enclosure enables these switches to withstand water washdown cleaning
- Rotatable head gives eight possible actuator entry points for versatile installation. A blanking plug is supplied for the unused entry.
- Long life—these switches, with their stainless steel actuators, are designed for a minimum of two million actuations
- Available in 2 or 4 contact pole versions. The 4 contact pole version provides 2 poles for dual channel safety monitoring and 2 additional poles for status monitoring.
- An optional stainless steel guide is available for demanding applications



Conforms to EN1088, EN292, EN60947-5-1, EN60204-1  
UL and C-UL listed, BG approved

## Ordering Information

Model	Part Number	Description
T4012-011	44538-2010	T4012 BASE MODEL, 1N/C+1N/O, M20
T4012-020	44538-2020	T4012 BASE MODEL, 2N/C, M20
T4012-020TM	44538-0120	T4012 BASE MODEL, 2N/C, M20/NPT ADAPTER
T4012-022	44538-2040	T4012 BASE MODEL, 2N/C+2N/O, M20
T4012-022TM	44538-0140	T4012 BASE MODEL, 2N/C+2N/O, M20/NPT ADAPTER
T4012-031	44538-2030	T4012 BASE MODEL, 3N/C+1N/O, M20
T4012-031TM	44538-0130	T4012 BASE MODEL, 3N/C+1 N/O, M20/NPT ADAPTER
SRH34-90	44534-0790	T4012 REPLACEMENT HEAD
SBRL34-P70	44534-8070	T4012 PLASTIC SLIDE BOLT FOR RIGHT OR LEFT HAND DOOR
SBR34-MR30	44534-8130	T4012 BOLT FOR RIGHT-HUNG DOOR (YELLOW METAL)
SBL34-MR40	44534-8140	T4012 BOLT FOR LEFT-HUNG DOOR (YELLOW METAL)



## Heavy-Duty Metal-Body Safety Interlock Switch

- Rugged enclosure—the all metal housing and stainless steel actuator of the T4016 makes it suitable for harsh environments
- NEMA 6/IP67 enclosure enables these switches to withstand water washdown cleaning.
- Rotatable head gives eight possible actuator entry points for versatile installation. A blanking plug is supplied for the unused entry.
- Long life—these switches, with their stainless steel actuators, are designed for a minimum of two million actuations
- A variety of 4 contact pole versions provides 2 poles for dual channel safety monitoring and 2 additional poles for status monitoring



E  
E

## Ordering Information

Model	Part Number	Description
T4016-031SM	44539-0010	T4016 BASE MODEL,3NC+1NO, 90 ACTUATOR, 3 X 0.5 INCH NPT CONDUIT OPENINGS
T4016-031TM	44539-0110	T4016 BASE MODEL,3NC+1NO, FLAT ACTUATOR, 3 X 0.5 INCH NPT CONDUIT OPENINGS
T4016-031F1M	44539-0210	T4016 BASE MODEL, 3NC+1NO, FLEX 1 ACTUATOR, 3 X 0.5 INCH NPT CONDUIT OPENINGS
T4016-031	44539-2010	T4016 BASE MODEL, 3N/C+1N/O, 3 X 0.5 INCH NPT CONDUIT OPENINGS
SAG-SS80	44534-0780	T4016 STAINLESS STEEL ALIGNMENT GUIDE
SA35-TRB	44535-0700	T4016 REPLACEMENT FLAT ACTUATOR RB
SA35-SRB	44535-0710	T4016 REPLACEMENT 90-DEGREE ACTUATOR RB
SBR-M00	44535-8000	T4016 BRACKET WITH HANDLE FOR RIGHT-HUNG DOOR (YELLOW)
SBL-M00	44535-8010	T4016 BRACKET WITH HANDLE FOR LEFT-HUNG DOOR (YELLOW)

## Small Tongue-Operated Safety Interlock Switch

- Small size—these switches are ideal for guarding applications with space restrictions. Fits on 1 inch square tubing.
- NEMA 6 (IP67) enclosure enables these switches to withstand water washdown cleaning
- Rotatable head gives eight possible actuator entry points for versatile installation. A blanking plug is supplied for the unused entry.
- Long life—these switches, with their stainless steel actuators, are designed for a minimum of one million actuations
- Available with two contact poles. Contact configurations of 1 N/O and 1 N/C or 2 N/C are available to meet requirements of dual channel safety monitoring
- An optional stainless steel guide is available for demanding applications



Conforms to EN1088, EN292,  
EN60947-5-1, EN60204-1  
UL and C-UL listed

## Ordering Information

Model	Part Number	Description
T2008-11SM	44540-0010	T2008 BASE MODEL, 1 N/C+1 N/O, M16, 90 ACT'R+ADAPTER
T2008-02SM	44540-0020	T2008 BASE MODEL, 2 N/C, M16, 90 ACT'R+ADAPTER

## Slim Safety Door Switches with IP67 Rating

- Slim design with a width of only 17 mm (three-contact models)
- Reversible design allowing either front or rear mounting
- Built-in Switches with two- or three-terminal contact construction are available
- Operation Key with rubber mounting hole to absorb vibration and shock
- IP67 degree of protection



## Ordering Information

Model	Part Number	Description
D4GS-N1R-5	11021-0023	D4GS-N BASE MODEL, 1NC+1NO, HORIZONTAL, 5M CABLE
D4GS-N2R	11021-0025	D4GS-N BASE MODEL, 2NC, HORIZONTAL, 1M CABLE
D4GS-N2T	11021-0026	D4GS-N BASE MODEL, 2NC, VERTICAL, 1M CABLE
D4GS-N2R-5	11021-0031	D4GS-N BASE MODEL, 2NC, HORIZONTAL, 5M CABLE
D4GS-N3R-3	11021-0035	D4GS-N BASE MODEL, 2NC+1NO, HORIZONTAL, 3M CABLE
D4GS-N3R-5	11021-0037	D4GS-N BASE MODEL, 2NC+1NO, HORIZONTAL, 5M CABLE
D4GS-N4R	11021-0039	D4GS-N BASE MODEL, 3NC, HORIZONTAL, 1M CABLE
D4GS-NK1	11021-0045	D4GS-N OPERATION KEY, HORIZONTAL MOUNTING
D4GS-NK2	11021-0046	D4GS-N OPERATION KEY, VERTICAL MOUNTING
D4GS-NK4	11021-0047	D4GS-N OPERATION KEY, ADJUSTABLE MOUNTING (VERTICAL)

## Super Small Class 6-Contact Guard Lock Safety-Door Switch

- Wiring time is reduced with two types of wiring methods capable of one-touch attachment and removal
- A wide variety of built-in switches can be used for various devices. (4-, 5-, and 6-contact models are available)
- Key holding force of 1,300 N
- It is possible to change the key insertion point without detaching the head
- Drive solenoids directly from the controller
- Lockout slide key prevents workers from becoming trapped inside the hazardous area.

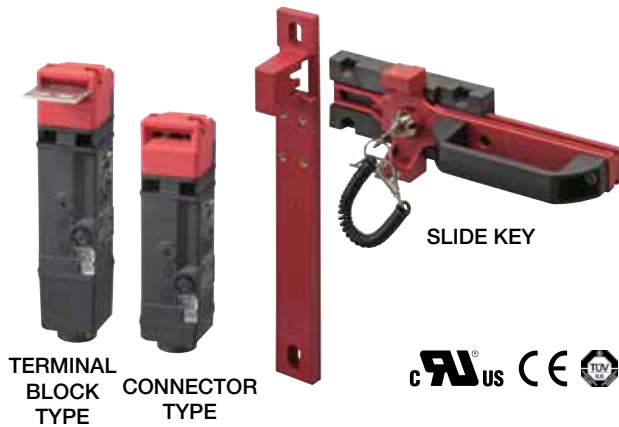

- The vertical door switch can be easily mounted on 40 x 40 mm aluminum frames.
- Plastic material makes the key suitable for lightweight doors.

## Ordering Information

Model	Part Number	Description
D4SL-N3HFG-DN	11079-2158	D4SL-N BASE MODEL, SOLENOID LOCK, 3NC+2NC, M20 CONDUIT WITH M20-TO-NPT ADAPTER, PLASTIC HEAD
D4SL-N2NFG-D4N	11079-2200	D4SL-N BASE MODEL, SOLENOID LOCK, 2NC/1NO+2NC/1NO, G 1/2 CONDUIT, PLASTIC HEAD
D4SL-N3NFA-D	11079-2225	D4SL-N BASE MODEL, SOLENOID RELEASE, 2NC/1NO+2NC/1NO, M20 CONDUIT WITH M20-TO-NPT ADAPTER, PLASTIC HEAD
D4SL-N3NFA-DN	11079-2226	D4SL-N BASE MODEL, SOLENOID RELEASE, 2NC/1NO+2NC/1NO, M20 CONDUIT WITH M20-TO-NPT ADAPTER, PLASTIC HEAD
D4SL-N3NFA-D4	11079-2227	D4SL-N BASE MODEL, SOLENOID RELEASE, 2NC/1NO+2NC/1NO, M20 CONDUIT WITH M20-TO-NPT ADAPTER, PLASTIC HEAD
D4SL-N3NFG-D	11079-2229	D4SL-N BASE MODEL, SOLENOID LOCK, 2NC/1NO+2NC/1NO, M20 CONDUIT WITH M20-TO-NPT ADAPTER, PLASTIC HEAD
D4SL-N3NFG-DN	11079-2230	D4SL-N BASE MODEL, SOLENOID LOCK, 2NC/1NO+2NC/1NO, M20 CONDUIT WITH M20-TO-NPT ADAPTER, PLASTIC HEAD
D4SL-N3NFG-D4	11079-2231	D4SL-N BASE MODEL, SOLENOID LOCK, 2NC/1NO+2NC/1NO, M20 CONDUIT WITH M20-TO-NPT ADAPTER, PLASTIC HEAD
D4SL-N3QFA-D	11079-2241	D4SL-N BASE MODEL, SOLENOID RELEASE, 3NC+2NC/1NO, M20 CONDUIT WITH M20-TO-NPT ADAPTER, PLASTIC HEAD
D4SL-NK1	11079-3001	D4SL-N OPERATION KEY, HORIZONTAL
D4SL-NK2	11079-3002	D4SL-N OPERATION KEY, VERTICAL
D4SL-NK3	11079-3003	D4SL-N OPERATION KEY, ADJUSTABLE (HORIZONTAL)
D4SL-NK1S	11079-3004	D4SL-N OPERATION KEY, HORIZONTAL MOUNTING (SHORT)
D4SL-NK1G	11079-3005	D4SL-N OPERATION KEY, HORIZONTAL (RUBBER BUSHING)
D4SL-NK2G	11079-3006	D4SL-N OPERATION KEY, VERTICAL (RUBBER BUSHING)
D4SL-NSK10-LK	11079-4001	D4SL-N SLIDE KEY
D4SL-CN3	11079-0106	D4SL CONNECTOR CABLE, 3M
D4SL-CN5	11079-0107	D4SL CONNECTOR CABLE, 5M

## Guard Lock Safety-Door Switch

- Best-selling guard lock safety-door switch available in several compact, multi-contact models
- Selectable Operation Key insertion direction and adjustable mounting ensure installation flexibility
- Built-in switches with multiple-contact construction are available
- Key holding force of 1,300 N minimum
- Can be used for either standard loads or microloads
- Lineup includes models with a conduit size of M20
- IP67 degree of protection
- Variety of metallic heads available



## Ordering Information

Model	Part Number	Description
D4NL-4EFA-B-NPT	11025-0174	D4NL BASE MODEL, M20, 2NC/1NO+1NC/1NO, PLASTIC, MECHANICAL LOCK, NPT
D4NL-4EFG-B-NPT	11025-0176	D4NL BASE MODEL, M20, 2NC/1NO+1NC/1NO, PLASTIC, 24VDC SOLENOID LOCK, NPT
D4NL-4FFA-B-NPT	11025-0178	D4NL BASE MODEL, M20, 2NC/1NO+2NC, PLASTIC, MECHANICAL LOCK, NPT
D4NL-4FFG-B-NPT	11025-0180	D4NL BASE MODEL, M20, 2NC/1NO+2NC, PLASTIC, 24VDC SOLENOID LOCK, NPT
D4NL-4EDA-B4-NPT	11025-0189	D4NL BASE MODEL, M20, 2NC/1NO+1NC/1NO, METAL, MECHANICAL LOCK, SPECIAL RELEASE KEY, NPT
D4NL-4GDA-B4-NPT	11025-0190	D4NL BASE MODEL, M20, 3NC+1NC/1NO, METAL, MECHANICAL LOCK, SPECIAL RELEASE KEY, NPT
D4NL-4EDG-B4-NPT	11025-0191	D4NL BASE MODEL, M20, 2NC/1NO+1NC/1NO, METAL, 24VDC SOLENOID LOCK, SPECIAL RELEASE KEY, NPT
D4NL-4GDG-B4-NPT	11025-0192	D4NL BASE MODEL, M20, 3NC+1NC/1NO, METAL, 24VDC SOLENOID LOCK, SPECIAL RELEASE KEY, NPT
D4NL-4GDA-B4S-NPT	11025-0336	D4NL BASE MODEL, M20, 3NC+1NC/1NO, METAL, MECHANICAL LOCK, SPECIAL RELEASE KEY, FRONT KEY, NPT
D4DS-K1	11018-0011	D4NL, D4NS OPERATION KEY, HORIZONTAL MOUNTING
D4DS-K2	11018-0012	D4NL, D4NS OPERATION KEY, VERTICAL MOUNTING
D4DS-K3	11018-0013	D4NL, D4NS OPERATION KEY, ADJUSTABLE MOUNTING (HORIZONTAL)
D4DS-K5	11018-1005	D4NL, D4NS OPERATION KEY, ADJUSTABLE MOUNTING (HORIZONTAL/VERTICAL)
D4NL-RK	11025-9001	D4NL SPECIAL RELEASE KEY

## Safety Interlock Switch with Guard Door Locking

- High locking force of 1,200 N (270 lb.) locks guard door shut until machine is safe to enter
- IP67 (NEMA 6) enclosure enables the TL4019 to withstand water washdown
- Door and lock monitoring—the TL4019 has a total of 4 contacts: 2 N/C safety + 1 contact for door position monitoring + 1 contact for lock monitoring



Conforms to EN1088, EN60947-5-1, EN292, EN60204-1  
UL and C-UL listed, BG approved

## Ordering Information

Model	Part Number	Description
TL4019-10241TM	44534-0010	TL4019 (FLAT ACTUATOR), 24VAC/DC, 2N/C+2 N/O, 3XM20 W/NPT ADAPTER
TL4019-20241TM	44534-0030	TL4019 (FLAT ACTUATOR), 24VAC/DC, 2 N/C+2 N/O, 3XM20 W/NPT ADAPTER
TL4019-30241TM	44534-0050	TL4019 (FLAT ACTUATOR), 24VAC/DC, 2 N/C+1N/O+1N/O, 3XM20 W/NPT ADAPTER
TL4019-30242TM	44534-0070	TL4019 (FLAT ACTUATOR), 24VAC/DC, 2 N/C+1N/O+1N/C, 3XM20 W/NPT ADAPTER
TL4019-10241F1M	44534-0310	TL4019 (FLEX1 ACTUATOR), 24VAC/DC, 2 N/C+2 N/O, 3XM20 W/NPT ADAPTER
TL4019-30242F1M	44534-0370	TL4019 (FLEX1 ACTUATOR), 24VAC/DC, 2 N/C+1N/O+1N/C, 3XM20 W/NPT ADAPTER
TL4019-40241TM	44534-0410	TL4019 (FLAT ACTUATOR), 24VAC/DC, 2 N/C+1N/O+1N/O, 3XM20 W/NPT ADAPTER
TL4019-40242TM	44534-0430	TL4019 (FLAT ACTUATOR), 24VAC/DC, 2 N/C+1N/O+1N/C, 3XM20 W/NPT ADAPTER
TL4019-40241SM	44534-0510	TL4019 (90-DEGREE ACTUATOR), 24VAC/DC, 2 N/C+1N/O+1N/O, 3XM20 W/NPT ADAPTER
TL4019-50241SM	44534-0570	TL4019 (90-DEGREE ACTUATOR), 24VAC/DC, 1 N/C+1N/C+1N/O, 3XM20 W/NPT ADAPTER
TL4019-40241F1M	44534-1710	TL4019 (FLEX1 ACTUATOR), 24VAC/DC, 2 N/C+1N/O+1N/O, 3XM20 W/NPT ADAPTER
TL4019-40242F1M	44534-1730	TL4019 (FLEX1 ACTUATOR), 24VAC/DC, 2 N/C+1N/O+1N/C, 3XM20 W/NPT ADAPTER
TL4019-10241	44534-2010	TL4019 BASE MODEL, 24VAC/DC, 2N/C+2 N/O, 3XM20 (SWITCH ONLY)
TL4019-20241	44534-2030	TL4019 BASE MODEL, 24VAC/DC, 2 N/C+2 N/O, 3XM20 (SWITCH ONLY)
TL4019-30241	44534-2050	TL4019 24VAC/DC, 2 N/C+1N/O+1N/O, 3XM20 (SWITCH ONLY)
TL4019-31101	44534-2060	TL4019 BASE MODEL, 110 VAC, 2 N/C+1N/O+1N/O, 3XM20 (SWITCH ONLY)
TL4019-30242	44534-2070	TL4019 BASE MODEL, 24VAC/DC, 2 N/C+1N/O+1N/C, 3XM20 (SWITCH ONLY)
TL4019-30243	44534-2090	TL4019 BASE MODEL, 24VAC/DC, 2 N/C+1N/C+1N/O, 3XM20 (SWITCH ONLY)
TL4019-40241	44534-2110	TL4019 BASE MODEL, 24VAC/DC, 2 N/C+1N/O+1N/O, 3XM20 (SWITCH ONLY)
TL4019-41101	44534-2120	TL4019 BASE MODEL, 110 VAC, 2 N/C+1N/O+1N/O, 3XM20 (SWITCH ONLY)
TL4019-40242	44534-2130	TL4019 BASE MODEL, 24VAC/DC, 2 N/C+1N/O+1N/C, 3XM20 (SWITCH ONLY)
TL4019-40243	44534-2150	TL4019 BASE MODEL, 24VAC/DC, 2 N/C+1N/C+1N/O, 3XM20 (SWITCH ONLY)
TL4019-50241	44534-2170	TL4019 BASE MODEL, 24VAC/DC, 1 N/C+1N/C+1N/O, 3XM20 (SWITCH ONLY)
TL4019-30241RR	44534-3050	TL4019 BASE MODEL, 24VAC/DC, 2 N/C+1N/O+1N/O, 3XM20
SA34-T	44534-0700	TL4019 REPLACEMENT FLAT ACTUATOR
SA34-TOT	44534-0701	TL4019 REPLACEMENT FLAT ACTUATOR OT
SA34-5	44534-0710	TL4019 REPLACEMENT 90-DEGREE ACTUATOR
SA34-F2	44534-0720	TL4019 REPLACEMENT FLEX 2 ACTUATOR
SA34-F2OT	44534-0721	TL4019 REPLACEMENT FLEX 2 ACTUATOR OT
SA34-F1	44534-0730	TL4019 REPLACEMENT FLEX 1 ACTUATOR
SA34-F1OT	44534-0731	TL4019 REPLACEMENT FLEX 1 ACTUATOR OT
SA34-TRB	44534-0740	TL4019 REPLACEMENT FLAT ACTUATOR RB
SA34-TRBOT	44534-0741	TL4019 REPLACEMENT FLAT ACTUATOR OTRB
SA34-SRB	44534-0750	TL4019 REPLACEMENT 90-DEGREE ACTUATOR RB
SM34-LED61	44534-0761	TL4019 LED LID KIT
SM34-KLR02	44534-0802	TL4019 KEY LOCK RELEASE (2 KEYS INCLUDED)
SBLK34-R50	44534-8050	TL4019 SLIDE BOLT INTERIOR LEVER KIT (USE WITH REAR RELEASE SLIDE BOLTS ONLY)
SBRH-R60	44534-8060	TL4019 REAR RELEASE T-HANDLE

## Safety Interlock Switch with Guard Door Locking

- High locking force of 1,500 N (337 lb.) locks guard door shut until machine is safe to enter
- IP67 (NEMA 6) enclosure withstands water washdown
- Door and lock monitoring—the TL4024 has a total of 4 contacts: 2 N/C safety + 1 contact for door position monitoring + 1 contact for lock monitoring
- Unlocking is possible with a back load on the door to satisfy the demands of high cycle time applications
- Narrow profile enables mounting to 2 in. square tubing or in applications with space restrictions
- Rotatable head—the rotatable head provides 8 actuator entry positions to satisfy most installation requirements
- Optional key release—this option on power-to-unlock models allows manual unlocking of the guard door



Conforms to EN1088, EN60947-5-1, EN292, EN60204-1  
UL and C-UL listed, BG approved

- Optional slide bolt with integral door handle aids installation on sliding and swinging guard doors
- Two LED (red/green) status indicators on the lid may be wired to suit the application

## Ordering Information

Model	Part Number	Description
TL4024-10242TM	44535-0010	TL4024 BASE MODEL, 24VAC/DC, 2N/C+ 1N/O+1N/C, FLAT ACTUATOR
TL4024-10242SM	44535-0110	TL4024 BASE MODEL, 24VAC/DC, 2N/C+ 1N/O+1N/C, 90-DEGREE ACTUATOR
TL4024-10242	44535-2010	TL4024 BASE MODEL, 24VAC/DC, 2N/C+1N/O+1N/C, 3 X .05 IN. NPT CONDUIT
TL4024-10243	44535-2030	TL4024 BASE MODEL, 24VAC/DC, 2N/C+1N/O+1N/O, 3 X .05 IN. NPT CONDUIT
SA35-F1	44535-0750	TL4024 REPLACEMENT FLEX 1 ACTUATOR

## Guard Lock Safety-Door Switch

- Holding force of 3,000 N
- Two safety circuits and two monitor contacts provide an array of monitoring patterns.
- Standard gold-clad contacts enable use with ordinary loads and microloads.
- Models with trapped keys prevent workers from being locked in hazardous work areas.
- Models with rear release buttons allow people to unlock the Switch and escape if they are locked into hazardous areas.
- IP67 degree of protection



## Ordering Information

Model	Part Number	Description
D4JL-2NFA-C5	11022-0004	D4JL BASE MODEL, SPECIAL RELEASE KEY, GREEN, MECHANICAL LOCK, 2NC/1NO+2NC/1NO
D4JL-2NFA-D5	11022-0036	D4JL BASE MODEL, SPECIAL RELEASE KEY, ORANGE, MECHANICAL LOCK, 2NC/1NO+2NC/1NO
D4JL-2NFA-C6	11022-0068	D4JL BASE MODEL, SPECIAL RELEASE KEY+REAR RELEASE, GREEN, MECHANICAL LOCK, 2NC/1NO+2NC/1NO
D4JL-K1	11022-0001	D4JL OPERATION KEY, HORIZONTAL MOUNT
D4JL-K2	11022-0002	D4JL OPERATION KEY, VERTICAL MOUNT
D4JL-K3	11022-0254	D4JL OPERATION KEY, ADJUSTABLE MOUNT (HORIZONTAL)
D4JL-SK40	11022-0194	D4JL MOUNTING SLIDE KEY



## Most Diverse and Flexible Line of Coded Magnetic Safety Interlock Switches and Controllers

- Combine door switch monitoring and E-stop monitoring by using the CM-S41 controller
- Monitor is single switch to CAT4 with the CM-S30 controller
- Monitor multiple switches to CAT3 using CM-S4 or CM-S30 controllers
- Monitoring multiple switches on individual channels can be achieved by using the CM-S21 or CM-S41 controllers. Easily expand your system by using the CM-SE expansion module.
- All CM switches are rated IP67
- Stainless steel switches are available for harsh environments



Conforms to EN292, EN60204-1, EN954-1, EN1088, EN60947-5-3, EN947-5-3, EN50081, EN50082, EN61000-6-2, ISO 13849-1  
UL and C-UL listed, TUV certified

## Ordering Information

Model	Part Number	Description
CM-S4	44536-0040	CM-S4 BASE MODEL, CONTROL (24VAC/DC) 1N/O+1N/O AUX.
CM-S1PC3	44536-0100	CM-S1 BASE MODEL, SWITCH & ACT WITH 1N/O+1N/C, 3 M CABLE
CM-S1PC5	44536-0105	CM-S1 BASE MODEL, SWITCH & ACT WITH 1N/O+1N/C, 5 M CABLE
CM-S21-24	44536-0120	CM-S21 BASE MODEL, CONTROL (24 VAC/DC) 2N/O+1N/C AUX.
CM-S2PC3	44536-0200	CM-S2 BASE MODEL, SWITCH & ACT WITH 1N/O+1N/C, 3 M CABLE
CM-S221PC5	44536-0221	CM-S221PC5 BASE MODEL, SWITCH & ACT WITH 2NO+1NC, 5M CABLE
CM-S521PC5	44536-0521	CM-S521 BASE MODEL, SWITCH & ACT WITH 2N/C+1N/O, 5 M CABLE
CM-S621PC5	44536-0621	CM-S5621 BASE MODEL, SWITCH & ACT WITH 2N/C+1N/O, 5 M CABLE
CM-S621PC10	44536-1621	CM-S621 BASE MODEL, SWITCH & ACT WITH 2N/C+1N/O, 10 M CABLE
CM-S31SC3	44536-3100	CM-S31 BASE MODEL, SWITCH+ACT, 3M CABLE
CM-S31SC5	44536-3105	CM-S31 BASE MODEL, SWITCH+ACT, 5M CABLE

## Magnetically Actuated Safety Interlock Switches

- Large selection—choose from a large selection of contact configurations housed in plastic to satisfy most application requirements
- NEMA 6 enclosure enables the MA Series switches to satisfy most application requirements (MA 3, 4, 5 are NEMA 4)
- Misalignment tolerant—the non-contact actuation of the switches makes them very tolerant to misalignment of up to 10 mm (0.39 in.)
- Variety of terminations—select various cable lengths or terminal strip termination for easy installation. Cable connector on selected models



Conforms to EN1088, EN292, EN60204-1  
UL and C-UL listed

- Long life—the MA Series is designed for a minimum of one million actuations

## Ordering Information

Model	Part Number	Description
MA-1APC4	44507-0020	MA-1 BASE MODEL (AC ONLY), 1N/C, 4M CABLE SWITCH+ACTUATOR
MA-1APC8	44507-0180	MA-1 BASE MODEL (AC ONLY), 1N/C, 8M CABLE SWITCH+ACTUATOR
MA-10APC2	44507-0110	MA-10 BASE MODEL (110 VAC ONLY), 1N/C, 2M CABLE, SWITCH+ACTUATOR
MA-10APC4	44507-0330	MA-10 BASE MODEL (110 VAC ONLY), 1N/C, 4M CABLE, SWITCH+ACTUATOR
MA-15DP21C3	44507-1540	MA-15 BASE MODEL (24VDC ONLY), 2N/C+1N/O 3M CABLE, SWITCH+ACT'R (300MA MAX.)
MA-15DP21C5	44507-1541	MA-15 BASE MODEL (24VDC ONLY), 2N/C+1N/O 5M CABLE, SWITCH+ACT'R (300MA MAX.)
MA-15DP21CC	44507-1549	MA-15 BASE MODEL (24VDC ONLY), 2N/C+1N/O CONNECTOR, MALE M12, SW+ACT'R (300MA MAX.)
MA16DP11C3	44507-1620	MA-16 BASE MODEL (24VDC ONLY), 1N/C, 1N/O, 3M CABLE, SWITCH & ACTUATOR
MA16DP11C6	44507-1621	MA-16 BASE MODEL (24VDC ONLY), 1N/C, 1N/O, 6M CABLE, SWITCH & ACTUATOR
MA16DP10C3	44507-1610	MA-16 BASE MODEL (24VDC ONLY), 1N/C, 3M CABLE, SWITCH & ACTUATOR
MA16DP10C6	44507-1611	MA-16 BASE MODEL (24VDC ONLY), 1N/C, 6M CABLE, SWITCH & ACTUATOR
MA16DP21C3	44507-1640	MA-16 BASE MODEL (24VDC ONLY), 2 N/C, 1N/O, 3M CABLE, SWITCH & ACTUATOR
MA-16AP11C6	44507-1661	MA-16 BASE MODEL (AC ONLY), 1N/C, 1N/O 6M CABLE, SWITCH & ACTUATOR
MA-16AP11C3	44507-1660	MA-16 BASE MODEL (AC ONLY), 1N/C, 1N/O, 3M CABLE, SWITCH & ACTUATOR
MA-16AP10C3	44507-1650	MA-16 BASE MODEL (AC ONLY), 1N/C, 3M CABLE, SWITCH & ACTUATOR
MA-16AP10C6	44507-1651	MA-16 BASE MODEL (AC ONLY), 1N/C, 6M CABLE, SWITCH & ACTUATOR
MA-2DPC15	44507-0370	MA-2 BASE MODEL (24VDC ONLY), 1N/C+1N/O, 15M CABLE, SWITCH+ACTUATOR
MA-2DPCC	44507-0650	MA-2 BASE MODEL (24VDC ONLY), 1N/C+1N/O, CONNECTOR 4-PIN MICRO DC, SWITCH+ACTUATOR
MA-2APC4	44507-0040	MA-2 BASE MODEL (AC ONLY), 1N/C+1N/O, 4M CABLE, SWITCH+ACTUATOR
MA-20DPCC	44507-0630	MA-20 BASE MODEL (24VDC ONLY), 2N/C, CONNECTOR 4-PIN MICRO DC M12, SWITCH+ACTUATOR
MA-21DPCC	44507-0670	MA-21 BASE MODEL (24VDC ONLY), 2N/C+1N/O, CONNECTOR, SWITCH+ACTUATOR
MA-34DS11C3	44507-3420	MA-34 BASE MODEL, 1N/C+1N/O, 3M CABLE, SWITCH+ACTUATOR
MA-35DS21C3	44507-3540	MA-35 BASE MODEL, 2N/C+1N/O, 3M CABLE, SWITCH+ACTUATOR (300MA MAX.)
MA-35DS21C5	44507-3541	MA-35 BASE MODEL, 2N/C+1N/O, 5M CABLE, SWITCH+ACTUATOR (300MA MAX.)
MA-35DS21CC	44507-3549	MA-35 BASE MODEL, 2N/C+1N/O, M12 MALE CONNECTOR, SWITCH+ACTUATOR (300MA MAX.)
MA-36DS11C3	44507-3620	MA-36 BASE MODEL, 1N/C+1N/O, 3M CABLE, SWITCH & ACTUATOR
MA-36AS10C3	44507-3650	MA-36 BASE MODEL, 1N/C, 3M CABLE, SWITCH & ACTUATOR
MA-4APTC	44507-0060	MA-4 BASE MODEL (AC ONLY), 1N/C+1N/O, TERMINAL CONNECTION, SWITCH+ACTUATOR
SA07-MA00	44507-0700	MA 1-5, 20 & 21 REPLACEMENT ACTUATOR RED ABS PLASTIC
SA07-MA10	44507-0710	MA 6, 9 & 10 REPLACEMENT ACTUATOR RED ABS PLASTIC
SA07-MA16	44507-0716	MA-10-16 REPLACEMENT ACTUATOR RED ABS PLASTIC

# D40Z/D40A/G9SX-NS

## Safety Interlock Switches

Quick Link

S362

omron247.com

### Compact Non-contact Door Switch/ Flexible Safety Unit

- Up to 30 units can be connected to a single G9SX (15 units with G9SP) Controller
- Troubleshooting is made easy with the switch's two-color diagnostic LED display patterns
- Photocoupler monitor output allows connection to a general-purpose PLC (NPN type)



### D40Z

- Supports ISO 13849-1 (Safety Category 4/PLe)
- Non-magnetic actuator will not attract metal fillings



### D40A

- Magnetic actuator

### Ordering Information

Model	Part Number	Description
D40A-1C5	11008-6002	D40A BASE MODEL, SWITCH AND ACTUATOR, 5M CABLE
D40Z-1C2	11081-0001	D40Z BASE MODEL, SWITCH AND ACTUATOR, 2M CABLE
D40Z-1C5	11081-0002	D40Z BASE MODEL, SWITCH AND ACTUATOR, 5M CABLE
D40Z-1C-A	11081-0003	D40Z BASE MODEL, ACTUATOR ONLY

## Stainless Steel Magnetically Actuated Safety Interlock Switches and Actuators

- Stainless steel cases—both switch and actuator are housed in stainless steel for applications that require the use of this robust and corrosion resistant material
- Large selection—choose from a variety of contact configurations housed in stainless steel to satisfy the most demanding applications
- NEMA 6 enclosure enables the MA-S Series switches to satisfy most application requirements
- Misalignment tolerant—the non-contact actuation of the MA-S Series switches makes them very tolerant to misalignment of up to 10 mm (0.39 in.)
- High temperature—the MA-S switches and cables are designed to operate in temperatures up to 125°C (257°F)
- Long life—the MA-S Series safety interlock switches are designed for a minimum of one million actuations



Conforms to EN1088, EN292,  
EN60204-1  
UL and C-UL listed

## Ordering Information

Model	Part Number	Description
MA-S21DSC3	44507-0450	MA-S21 BASE MODEL, 2N/C+1N/O, 3M CABLE, SWITCH+ACTUATOR

## Magnetic Ferroresonant Stand-alone Safety Interlock Switch

- Tamper resistant—the combination of magnetic and ferroresonant signals required to close the safety contacts makes the MFS very tamper resistant
- Standalone—use for lower risk applications as a stand-alone safety switch allowing direct switching of relays and contactors up to 2 A at 230 VAC
- MFS-11 provides a visible LED which illuminates green when the actuator is in range and contacts are closed
- MFS-12 provides a dual color LED indicator. LED illuminates green when the actuator is in range and the contacts are closed. LED illuminates Red when the actuator is out of range and contacts are open.
- Compact size—mounts easily on 1-in. square tubing
- Use with safety monitoring relays in applications requiring a higher level of safety reliability
- NEMA 4 enclosure enables water wash-down cleaning



Conforms to EN1088, EN292, EN60204-1, EN954-1, EN947-5-3, EN60947-5-1, EN50081, EN50082, EN61000-6-2  
UL and C-UL listed

E  
E

## Ordering Information

Model	Part Number	Description
MFS-11P11C3	44508-1120	MFS BASE MODEL, SWITCH & ACTUATOR, 1N/C+1N/O, 3M CABLE
MFS-11P11C6	44508-1121	MFS BASE MODEL, SWITCH & ACTUATOR, 1N/C+1N/O, 6M CABLE
MFS-11P11CC5	44508-1128	MFS BASE MODEL, SWITCH & ACTUATOR, 1N/C+1N/O, M12 MALE CONNECTOR+5M CABLE
MFS-11P20C10	44508-1132	MFS BASE MODEL, SWITCH & ACTUATOR, 2N/C, 10M CABLE
MFS-12P21C6	44508-1133	MFS BASE MODEL,-12 SWITCH & ACTUATOR, 2N/C+1N/O, 6M CABLE
MFS-12P21CC5	44508-1134	MFS-12 BASE MODEL, SWITCH & ACTUATOR, 2N/C+1N/O, M12 MALE CONNECTOR+5M CABLE
MFS-11P20CC	44508-1139	MFS BASE MODEL, SWITCH & ACTUATOR, 2N/C, M12 MALE CONNECTOR

## Safety-door Hinge Switch

- Compact, plastic-body safety-door hinge switch designed for saving space in machines
- Lineup includes three contact models with 2NC/1NO and 3NC contact forms in addition to the previous contact forms 1NC/1NO, and 2NC. Models with MBB contacts are also available
- M12-connector models are available, saving on labor and simplifying replacement
- Standardized gold-clad contacts provide high contact reliability. Can be used with both standard loads and microloads.



## Ordering Information

Model	Part Number	Description
D4NH-4CAS-NPT	11024-0105	D4NH BASE MODEL, SHAFT ACTUATOR, 1-CONDUIT, NPT, 2NC/1NO
D4NH-4CBC-NPT	11024-0107	D4NH BASE MODEL, ARM LEVER ACTUATOR, 1-CONDUIT, NPT, 2NC/1NO
D4NH-4BBC-NPT	11024-0108	D4NH BASE MODEL, ARM LEVER ACTUATOR, 1-CONDUIT, NPT, 2NC
D4NH-4ABC-NPT	11024-0109	D4NH BASE MODEL, ARM LEVER ACTUATOR, 1-CONDUIT, NPT, 1NC/1NO

## Contents

<b>Rope Pulls</b>		
ER5018	Compact Rope Pull Emergency Stop Switch	FF-2
ER6022	Rope Pull Emergency Stop Switch	FF-3
ER6022-SS	Stainless Steel Rope Pull Emergency Stop Switch	FF-4
ER1022/ ER1032	Rope Pull Emergency Stop Switches	FF-5
<b>E-Stops</b>		
A22E	22 or 25 mm Diameter Emergency Stop Switch	FF-6
A165E	16 mm Diameter Emergency Stop Switch	FF-7

## Compact Rope Pull Emergency Stop Switch

- Compact size allows this switch to be used on smaller machines with a mounting width of 40 mm (1.57 in.) and covering rope spans up to 40 m (131 ft.)
- Tension indicator makes system setup and rope tension maintenance easy
- Contact arrangements of 2 N/C + 1 N/O or 3 N/C
- IP67 (NEMA 6) enclosure enables the ER5018 switch to withstand water wash-down cleaning
- Heavy-duty housing—the die-cast housing and stainless steel eye nut makes the ER5018 suitable for demanding industrial applications
- Integral E-Stop—the optional E-stop provides emergency stopping at the extreme end of the installation
- Reset button—the blue reset button must be pushed in order to return to “machine run” condition following switch actuation by a pulled or slacked rope
- Vibration tolerant—the snap-acting switch contacts protect against nuisance tripping due to vibration
- Rubber bellows contain UV inhibitor making the switches suitable for outdoor applications



  
 Conforms to IEC947-5-1, IEC947-5-5, EN418, UL508, BS5304  
 UL and C-UL listed, TUV certified

## Ordering Information

Model	Part Number	Description
ER5018-021M	44506-4010	ER5018 BASE MODEL, 2N/C+1N/O, M20
ER5018-021N	44506-4020	ER5018 BASE MODEL, 2N/C+1N/O, 1/2 IN. NPT
ER5018-021NE	44506-4120	ER5018 BASE MODEL, 2N/C+1N/O, 1/2 IN. NPT, E STOP



## Rope Pull Emergency Stop Switch

- Rope spans up to 80 m (262 ft.) means fewer number of switches required per application
- Tension indicator makes system setup and rope tension maintenance easy
- Contact arrangements of 2 N/C + 1 N/O, 3 N/C + 1 N/O or 2 N/C + 2 N/O
- IP67 (NEMA 6) enclosure enables the ER6022 switch to withstand water wash-down cleaning
- Reset button—the blue reset button must be pushed in order to return to “machine run” condition following switch actuation by a pulled or slacked rope
- Indicator beacon—the optional dual indicator beacon, available in 24 VDC or 120 VAC, can be wired to flash red to indicate a tripped switch or glow a constant green to indicate a properly reset switch
- E-stop button—the ER6022 has two mounting positions where the optional E-stop button may be installed; the E-stop button may be added or replaced in the field
- Rubber bellows contain UV inhibitor making the switches suitable for outdoor applications



Conforms to IEC947-5-1, IEC947-5-5, EN418, UL508, BS5304  
UL and C-UL listed, TUV certified

## Ordering Information

Model	Part Number	Description
ER6022-021M	44506-5010	ER6022-BASE MODEL, 2N/C+1N/O, M20
ER6022-021ME	44506-5210	ER6022-BASE MODEL, 2N/C+1N/O, M20, E STOP
ER6022-021MEL	44506-5410	ER6022-BASE MODEL, 2N/C+1N/O, M20, E STOP, LED
ER6022-021NE	44506-5220	ER6022-BASE MODEL, 2N/C+1N/O, 1/2 IN. NPT, E STOP
ER6022-021NEL	44506-5420	ER6022-BASE MODEL, 2N/C+1N/O, 1/2 IN. NPT, E STOP, LED
ER6022-021NELAC	44506-5423	ER6022-BASE MODEL, 2N/C+1N/O, 1/2 IN. NPT, E STOP, 120VAC LED
ER6022-022MLSS	44506-5910	ER6022-BASE MODEL, 2NC+2NO,3 X M20, LED
ER6022-022N	44506-5080	ER6022-BASE MODEL, 2N/C+2N/O, 1/2 IN. NPT
ER6022-022NE	44506-5280	ER6022-BASE MODEL, 2N/C+2N/O, 1/2 IN. NPT, E-STOP
ER6022-022NEL	44506-5480	ER6022-BASE MODEL, 2N/C+2N/O, 1/2 IN. NPT, E-STOP, LED
ER6022-022NELSS	44506-5960	ER6022-BASE MODEL, 2NC+2NO,3 X 1/2 IN. NPT, E-STOP, LED

## Stainless Steel Rope Pull Emergency Stop Switch

- Rope spans up to 100 m (328 ft.) means fewer number of switches required per application
- Tension indicator maintains the proper rope tension
- Contact arrangements of 3 N/C + 1 N/O or 2 N/C + 2 N/O
- IP67 (NEMA 6) enclosure withstands water washdown cleaning
- 316 stainless steel cast housing and stainless steel hardware
- Reset button—the blue reset button must be pushed in order to return to “machine run” condition following switch actuation by a pulled or slacked rope
- Vibration tolerant—the snap-acting switch contacts protect against nuisance tripping due to vibration
- Indicator beacon—the dual indicator beacon is optional on the ER6022-SS; the indicator beacon can be wired to flash red to indicate a tripped switch or glow a constant green to indicate a properly reset switch
- Optional E-stop button—may be added or replaced in the field
- Rubber bellows contain UV inhibitor making the switches suitable for outdoor applications
- Extreme Cold Version—for applications down to -40°C



Conforms to IEC947-5-1, IEC947-5-5, EN418, UL508, BS5304  
UL and C-UL listed, TUV certified

# ER1022/ER1032 Rope Pull Emergency Stop Devices

## Common Features

- IP67 (NEMA 6) enclosure enables the switch to withstand water washdown cleaning
- Integral E-stop—the E-stop button provides emergency stopping capability at the extreme end of the installation and is field serviceable
- Tension indicator makes system setup and rope tension maintenance easy
- 4 N/C safety contacts and 2 N/O auxiliary contacts satisfy the most demanding applications
- Vibration tolerant—the snap-acting switch contacts protect against nuisance tripping due to vibration
- Indicator beacon—the indicator beacon, available in 24 VDC or 120 VAC, can be wired to flash red to indicate a tripped switch or glow a constant green to indicate a properly reset switch
- Rubber bellows contain UV inhibitor making the switches suitable for outdoor applications

## ER1022

Rope spans up to 125 m (410 ft.)



Conforms to IEC947-5-1, IEC947-5-5, EN418, UL508, BS5304  
UL and C-UL listed, TUV certified

## ER1032

Rope spans up to 200 m (656 ft.)



Conforms to IEC947-5-1, IEC947-5-5, EN418, UL508, BS5304  
UL and C-UL listed, TUV certified

**Quick Link** **S422** [omron247.com](http://omron247.com)

**Quick Link** **S423** [omron247.com](http://omron247.com)

## Ordering Information

Model	Part Number	Description
ER1022-042MELL	44506-6410	ER1022 BASE MODEL, 4N/C+2N/O, M20, E STOP, LED 24VDC, L
ER1022-042MELR	44506-6510	ER1022 BASE MODEL, 4N/C+2N/O, M20, E STOP, LED 24VDC, R
ER1022-042NELL	44506-6420	ER1022 BASE MODEL, 4N/C+2N/O, 1/2 IN. NPT, E STOP, LED 24VDC, L
ER1022-042NELR	44506-6520	ER1022 BASE MODEL, 4N/C+2N/O, 1/2 IN. NPT, E STOP, LED 24VDC, R

## Ordering Information

Model	Part Number	Description
ER1032-042MEL	44506-7410	ER1032 BASE MODEL, 4N/C+2N/O, M20, E STOP, LED 24VDC, D
ER1032-042NEL	44506-7420	ER1032 BASE MODEL, 4N/C+2N/O, 1/2 IN. NPT, E STOP, LED 24VDC, D
ER1032-042NELAC	44506-7421	ER1032 BASE MODEL, 4N/C+2N/O, 1/2 IN. NPT, E STOP, LED 120 VAC, D

## Emergency Stop Switch (22 mm or 25 mm diameter)

- Install in 22-dia. or 25-dia. panel cutout
- Direct opening mechanism to open the circuit when the contact welds
- Safety lock mechanism prevents operating errors
- Easy mounting and removal of Switch Blocks using a lever
- Mount three Switch Units in series to improve wiring efficiency (with non-lighted Switch Units, three Units can be mounted for multiple contacts)
- Finger protection mechanism on Switch Unit provided as a standard feature
- Install using either round, or forked crimp terminals

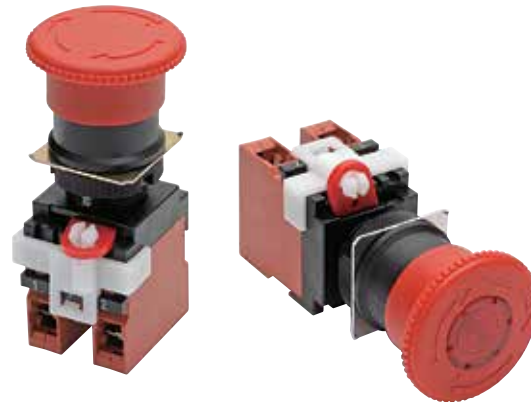

- Non-lighted versions are IP65 (oil resistant). Lighted versions are IP65
- A lock plate is provided as a standard feature to ensure that the control box and switch are not easily separated

## Ordering Information

Model	Part Number	Description
A22E-L-02	11004-7013	A22E BASE MODEL, NON-LIGHTED, PUSH-LOCK, TURN RESET, 2NC, 60 DIA.
A22EL-M-24A-02	11004-7010	A22E BASE MODEL, LIGHTED, PUSH-LOCK, TURN RESET, 2NC, 24V, NO REDUCTION, 40 DIA.
A22E-M	11004-2002	A22E BASE MODEL, NON-LIGHTED, PUSH-LOCK, TURN RESET, 40 DIA.
A22E-M-01	11004-7001	A22E BASE MODEL, NON-LIGHTED, PUSH-LOCK, TURN RESET, 1NC, 40 DIA.
A22E-M-02	11004-7002	A22E BASE MODEL, NON-LIGHTED, PUSH-LOCK, TURN RESET, 2NC, 40 DIA.
A22E-M-11	11004-7004	A22E BASE MODEL, NON-LIGHTED, PUSH-LOCK, TURN RESET, 1NC+1NO, 40 DIA.
A22E-M-12	11004-7051	A22E BASE MODEL, NON-LIGHTED, PUSH-LOCK, TURN RESET, 2NC+1NO, 40 DIA.
A22E-MP-02	11004-7034	A22E BASE MODEL, NON-LIGHTED, PUSH-PULL, 2NC, 40 DIA.
A22E-MP-11	11004-7036	A22E BASE MODEL, NON-LIGHTED, PUSH-PULL, 1NC+1NO, 40 DIA.
A22E-S-01	11004-7024	A22E BASE MODEL, NON-LIGHTED, PUSH-LOCK, TURN RESET, 1NC, 30 DIA.
A22E-S-02	11004-7025	A22E BASE MODEL, NON-LIGHTED, PUSH-LOCK, TURN RESET, 2NC, 30 DIA.

## Emergency Stop Switch (16 mm diameter)

- Separate construction with one of the smallest class of depths in the world
- Direct opening mechanism to open contacts in emergencies, such as when they are welded
- Conforms to EN418
- Includes a safety lock to prevent misuse
- Features separate construction that allows the switch to be separated for easier wiring and one-piece-like construction that allows easier handling
- Models available with 3 contacts built into a single block (A165E-U)



## Ordering Information

Model	Part Number	Description
A165E-S-01	11002-7007	A165E BASE MODEL, NON-LIGHTED, 30 DIA., SPST-NC
A165E-S-02	11002-7008	A165E BASE MODEL, NON-LIGHTED, 30 DIA., DPST-NC
A165E-S-03U	11002-7012	A165E BASE MODEL, NON-LIGHTED, 30 DIA., TPST-NC

# Emergency Stop Devices

---

## Contents

<b>Safety Limit Switches</b>		
D4N	Safety Limit Switch	GG-2
D4N-□R	Pull-reset Safety Limit Switch	GG-3
D4B-□N	Safety Limit Switch	GG-4
D4F	Small Safety Limit Switch	GG-5
<b>Safety Selector Switch</b>		
A22TK	Safety Key Selector Switch	GG-6
<b>Enabling Switch Device</b>		
A4EG	Enabling Grip Switch with Distinct Feel for Three Easily Discernible Positions	GG-7
<b>Two-Hand Control</b>		
TS	TouchStart™ Capacitive Palm Button	GG-8

## Safety Limit Switch

- Upgraded safety limit switches based on the popular D4D, providing a full lineup conforming to international standards
- Lineup includes three contact models with 2NC/1NO and 3NC contact forms in addition to the previous contact forms 1NC/1NO, and 2NC. Models with MBB contacts are also available
- M12-connector models are available, saving on labor and simplifying replacement
- Standardized gold-clad contacts provide high contact reliability. Can be used with both standard loads and microloads
- Conforms to EN115, EN81-1, and EN81-2 (slow-action models only)
- Lineup includes both slow-action and snap-action models with Zb contacts
- Certified standards: UL, EN (TÜV), and CCC



## Ordering Information

Model	Part Number	Description
D4N-4120-NPT	11023-0707	D4N BASE MODEL,1NC/1NO, ROLLER LEVER, SNAP ACT, M20+NPT
D4N-412G-NPT	11023-0702	D4N BASE MODEL,1NC/1NO, ADJ ROLLER LEVER, SNAP ACT, M20+NPT
D4N-4132-NPT	11023-0705	D4N BASE MODEL, 1NC/1NO, ROLLER PLUNGER, M20+NPT
D4N-4162-NPT	11023-0704	D4N BASE MODEL,1NC/1NO, ONE WAY ROLLER HORIZONTAL, SNAP ACT, M20+NPT
D4N-4172-NPT	11023-0703	D4N BASE MODEL,1NC/1NO, ONE WAY ROLLER VERTICAL, SNAP ACT, M20+NPT



## Pull-reset Safety Limit Switch

- A series of pull-reset models now available
- Lineup includes three contact models with 2NC/1NO and 3NC contact forms in addition to the previous contact forms 1NC/1NO and 2NC
- M12-connector models are available, saving on labor and simplifying replacement
- Standardized gold-clad contacts provide high contact reliability. Can be used with both standard loads and microloads
- Conforms to EN115, EN81-1 and EN81-2
- Certified standards: UL, EN (TÜV), and CCC



## Ordering Information

Model	Part Number	Description
D4N-4A32R-NPT	11023-0694	D4N-R BASE MODEL, 1NC+1NO, SLOW ACT, TOP ROLLER PLUNGER, M20+NPT
D4N-4A2GR-NPT	11023-0697	D4N-R BASE MODEL, 1NC+1NO, SLOW ACT, ADJ ROLLER LEVER, M20+NPT
D4N-4A20R-NPT	11023-0698	D4N-R BASE MODEL, 1NC+1NO, SLOW ACT, ROLLER LEVER, M20+NPT
D4N-4B2GR-NPT	11023-0699	D4N-R BASE MODEL, 2NC, SLOW ACT, ADJ ROLLER LEVER, M20+NPT

## Safety Limit Switch

- Snap-action contact with certified direct opening operation
- Direct opening mechanism (NC contacts only) added to enable opening contacts when faults occur, such as fused contacts
- Safety of lever settings ensured using a mechanism that engages a gear between the operating position indicator plate and the lever
- Equipped with a mechanism that indicates the applicable operating zone, as well as push-button switching to control left and right motion
- Head seal structure strengthened to improve seal properties (TÜV: IEC IP67, UL: NEMA 3, 4, 4X, 6P, and 13)
- Wide standard operating temperature range: -40 to 80°C
- Models with gold-plated contacts to enable handling microloads
- Certified standards: UL, CSA, EN (TÜV), and CCC



## Ordering Information

Model	Part Number	Description
D4B-4111N-NPT	11012-0020	D4B-N BASE MODEL, ROLLER LEVER, NPT,1NC/1NO
D4B-4113N-NPT	11012-4029	D4BN-N BASE MODEL, 1NC/1NO, SNAP ACTION, NPT
D4B-4115N-NPT	11012-0024	D4B-N BASE MODEL, ROLLER LEVER, STAINLESS STEEL, NPT, 1NC/1NO
D4B-4116N-NPT	11012-0025	D4B-N BASE MODEL, ADJUSTABLE ROLLER LEVER, NPT, 1NC/1NO
D4B-4117N-NPT	11012-4028	D4B-N BASE MODEL, ADJUSTABLE ROD LEVER, NPT, 1NC/1NO
D4B-4170N-NPT	11012-0026	D4B-N BASE MODEL, TOP PLUNGER, NPT, 1NC/1NO
D4B-4171N-NPT	11012-0022	D4B-N BASE MODEL, TOP ROLLER PLUNGER, M20+NPT1NC/1NO, SNAP ACTION
D4B-4A13N-NPT	11012-4027	D4B-N BASE MODEL, NPT, 2NC
D4B-4A71N-NPT	11012-0023	D4B-N BASE MODEL, TOP ROLLER PLUNGER, NPT, 2NC

## Small Safety Limit Switch

- Smallest class of safety limit switches
- Extra small limit switch with a direct opening mechanism (four-contact model)
- High-sensitivity safety limit switch
- Four contacts in either 2NC + 2NO or 4NC versions
- Degree of protection: IP67 (EN60947-5-1)
- Certified standards: UL, EN (TÜV), and CC



## Ordering Information

Model	Part Number	Description
D4F-302-1R	11019-0007	D4F BASE MODEL, 2NC+2NO, ROLLER PLUNGER, 1M CABLE, HORIZONTAL
D4F-102-3R	11019-0021	D4F BASE MODEL, 1NC+1NO, ROLLER PLUNGER, 3M CABLE, HORIZONTAL
D4F-202-3R	11019-0022	D4F BASE MODEL, 2NC, ROLLER PLUNGER, 3M CABLE, HORIZONTAL
D4F-302-3R	11019-0023	D4F BASE MODEL, 2NC+2NO, ROLLER PLUNGER, 3M CABLE, HORIZONTAL
D4F-120-3D	11019-0025	D4F BASE MODEL, 1NC+1NO, ROLLER LEVER, 3M CABLE, VERTICAL
D4F-302-3D	11019-0031	D4F BASE MODEL, 2NC+2NO, ROLLER PLUNGER, 3M CABLE, VERTICAL
D4F-120-5R	11019-0033	D4F BASE MODEL, 1NC+1NO, ROLLER LEVER, 5M CABLE, HORIZONTAL
D4F-320-5R	11019-0035	D4F BASE MODEL, 2NC+2NO, ROLLER LEVER, 5M CABLE, HORIZONTAL
D4F-220-5D	11019-0042	D4F BASE MODEL, 2NC, ROLLER LEVER, 5M CABLE, VERTICAL
D4F-320-5D	11019-0043	D4F BASE MODEL, 2NC+2NO, ROLLER LEVER, 5M CABLE, VERTICAL
D4F-420-5D	11019-0044	D4F BASE MODEL, 4NC, ROLLER LEVER, 5M CABLE, VERTICAL
D4F-302-5D	11019-0047	D4F BASE MODEL, 2NC+2NO, ROLLER PLUNGER, 5M CABLE, VERTICAL

## Safety Key Selector Switch

- Key-type selector switch with direct opening mechanism
- Selector Switch for secure equipment activation during maintenance
- 30 types of exclusive keys make it more difficult to disable
- The trapped key of the D4JL Guard Lock Safety-door Switch has the same shape as the locking key of the D4SL-SK10-LK Slide Key Unit. Units can be combined to improve safety. (Specify the same key type.)
- Common to the switch part of Emergency Stop Switch A22E. (Non-lighted model only)



## Ordering Information

Model	Part Number	Description
A22TK-2LL-02-K01	11004-8009	A22TK BASE MODEL, 2N/C, LEFT KEY RELEASE, LEFT N/C CLOSED, KEY INCLUDED
A22TK-2LR-12-K01	11004-8022	A22TK BASE MODEL, 1N/O+2N/C, LEFT KEY RELEASE, RIGHT N/C CLOSED, KEY INCLUDED
A22TK-2RL-02-K01	11004-8033	A22TK BASE MODEL, 2N/C, RIGHT KEY RELEASE, LEFT N/C CLOSED, KEY INCLUDED
A22TK-2RL-12-K01	11004-8034	A22TK BASE MODEL, 1N/O+2N/C, RIGHT KEY RELEASE, LEFT N/C CLOSED, KEY INCLUDED
A22Z-3466-1	11003-0053	A22E LEGEND PLATE, 60-DIA.
A22Z-B101Y	11003-0061	A22E CONTROL BOX
A22Z-EG1	11004-0001	A22E E-SHOP SHROUD FOR EMERGENCY OFF "EMO", YELLOW

## Enabling Grip Switch with Distinct Feel for Three Easily Discernible Positions

- The difficult task of configuring safety circuits is now easily achieved by combining the A4EG with the G9SX-GS
- In addition to the standard models, the lineup also includes models with an emergency stop switch and models with a momentary operation switch
- An optional Holding Key (sold separately) provides a versatile method for selecting modes
- Equipped with conduit connector



## Ordering Information

Model	Part Number	Description
A4EG-C000041	11073-0001	A4EG BASE MODEL, SWITCH ONLY, 2NC SAFETY, 1 AUX
A4EG-BM2B041	11073-0003	A4EG BASE MODEL, SWITCH ONLY, 2NC SAFETY, 2NO FUNCTION
A4EG-OP2	11073-0005	A4EG MOUNTING BRACKET
A4EG-OP3	11073-0006	A4EG HOLDING KEY
SC09-9M310	44509-0310	A4EG CABLE, 10-PIN MINI MALE, 9 MS
SC09-9M320	44509-0320	A4EG CABLE, 8-PIN MINI MALE, 9 MS
SC09-9M330	44509-0330	A4EG CABLE, 4-PIN MINI MALE, 10 MS
SC12-M16CG80	44512-0080	M16 CORD GRIP (4-5MM ID)
SC12-M20CG90	44512-0090	M20 CORD GRIP (4-5MM ID)

## Capacitive Palm Button

- No physical pressure required to actuate switch—reduces the likelihood of wrist injury caused by repetitive motion
- Excellent sensitivity—sensor is designed to operate even if operator is wearing gloves
- RFI Immunity—special circuitry inhibits output in the presence of RFI that would otherwise cause false triggering of output
- AC version is UL Recognized—meets the applicable requirements in the proposed first edition of UL 491
- Saves time and money
- Easy mounting in a single hole
- Wiring is simplified because terminals are clearly identified and easily accessible
- No special power supplies are required because switch is available in either 120 VAC or 24 VDC versions



## Ordering Information

Model	Part Number	Description
TS-10	44527-0010	TOUCHSTART BASE MODEL, 120 VAC, REV. 2

<b>Contents</b>		
<b>Safety Monitoring Relays</b>		
<b>Fixed Terminals</b>		
G9SA	Safety Relay Unit	HH-2
SR101A	Single-Channel Relay	HH-2
SR103AM	Dual-Channel Relay	HH-3
SR104P	Two-Hand Control Relay	HH-3
SR106ED	Safety Expansion Unit	HH-3
SR107, 108 & 109AD	Dual-Channel Relay	HH-4
SR125SMS45	Stop Motion Sensing Unit	HH-5
SR131A	Dual-Channel Relay	HH-6
<b>Safety Monitoring Relays</b>		
<b>Removable Terminals</b>		
SR203M & 203AM	Dual-Channel Relay	HH-6
SR208 & 209AD	Dual-Channel Relay	HH-7
<b>Force-Guided Relays</b>		
G7SA	Compact Slim Relays Conforming to EN Standards	HH-8
G7S-□-E	Lineup Now Includes 10A Models	HH-8



## Safety Relay Unit

- Four kinds of 45-mm wide units are available:  
A 3-pole model, a 5-pole model, and models with 3 poles and 2 OFF-delay poles, as well as a two-hand controller.  
Also available are 17.5 mm wide expansion units with 3 poles and 3 OFF-delay poles.
- Simple expansion connection
- OFF-delay models have 15-step OFF-delay settings



- Conforms to EN standards (BG approval)
- Both DIN track mounting and screw mounting are possible

## Ordering Information

Model	Part Number	Description
G9SA-301 AC/DC24	11054-6001	G9SA BASE MODEL, 3NO+1NC, 45MM, E-STOP CONTROL
G9SA-301 AC100-240	11054-6012	G9SA BASE MODEL, 3NO+1NC, 45MM, E-STOP CONTROL
G9SA-321-T075 AC/DC24	11054-6003	G9SA BASE MODEL, 3NO IMMEDIATE, 2NO DELAYED, 7.5 SEC.
G9SA-501 AC/DC24	11054-6002	G9SA BASE MODEL, 5NO+1NC, 45MM, E-STOP CONTROL
G9SA-EX301	11054-6007	G9SA BASE MODEL, 3NO+1NC, EXP MODULE, 45MM, NO DELAY

# SR101A Safety Monitoring Relays

## Single-Channel Monitoring Relay

- Power requirements—the SR101A will accept 24 VAC/DC or 115 VAC
- Inputs—a single N/C input channel, not monitored, is provided
- Outputs—the SR101A has two N/O outputs to route power to the coils of power contactors
- External Device Monitoring (EDM) is provided with a N/C loop between S11 and S21 on the SR101A
- Reset mode—an automatic reset mode is provided with the SR101A



## Ordering Information

Model	Part Number	Description
SR101A01	44510-1011	SR101 BASE MODEL, 24VAC/DC, 1 INPUT, 2 OUTPUTS



# SR103AM Safety Monitoring Relays

Quick Link

S368

omron247.com

## Dual-Channel Monitoring Relay

- Power requirements—the SR103AM will accept 24 VAC/DC or 115 VAC
- Inputs—the SR103AM will accept single or dual N/C inputs or dual inputs from a light curtain
- Outputs—the SR103AM has 3 N/O outputs to route power to the coils of power contactors, plus 1 N/C auxiliary output for signaling purposes
- External Device Monitoring (EDM) is provided with a N/C loop between S11/ S12 and S21 on the SR103AM
- Monitored manual or automatic/manual reset modes are available on the SR103AM.



Conforms to EN60204-1, EN954-1, VDE 0113-1  
UL and C-UL listed  
TÜV Rheinland approved

- Monitored manual reset requires closure of the reset circuit followed by opening of the circuit. Reset occurs when circuit is opened. Auto reset requires only closure of the reset circuit as reset occurs when circuit is closed

## Ordering Information

Model	Part Number	Description
SR103AM01	44510-1031	SR103 BASE MODEL, 24VAC/DC, 2 INPUTS, 3 OUTPUTS, 1 N/C AUX.
SR103AM02	44510-1032	SR103 BASE MODEL, 110 VAC, 2 INPUTS, 3 OUTPUTS, 1 N/C AUX.

# SR104P Safety Monitoring Relays

Quick Link

S369

omron247.com

## Two-Hand Control Monitoring Relay

- Power requirements—the SR104P will accept 24 VAC/DC and 115 VAC
- Inputs—controls and monitors two-hand control switches to ensure that both switches are operated within 0.5 seconds of each other
- Outputs—the SR104P has 2 N/O outputs to route power to the coils of power contactors
- External Device Monitoring (EDM) is provided with a N/C loop between X1 and X2 on the SR104P



Conforms to EN574 Cat. IIIC, EN60204-1, EN954-1, VDE 0113-1  
UL and C-UL listed, BG approved

## Ordering Information

Model	Part Number	Description
SR104P01	44510-1041	SR104 BASE MODEL, 24 VAC/DC, 2 HAND CONTROL UNIT, 2 OUTPUTS
SR104P02	44510-1042	SR104 BASE MODEL, 110 VAC, 2 HAND CONTROL UNIT, 2 OUTPUTS



# SR106ED Safety Monitoring Relays

**Quick Link**  
**S373**  
 omron247.com

## Safety Expansion Unit

- Power requirements—the SR106ED will accept 24 VAC/DC or 115 VAC
- Outputs—the SR106ED has 3 N/O delayed outputs to route power to the coils of power contactors (delay selectable from 1 to 30 sec.)
- Auxiliary Output—the SR106ED has 1 N/C auxiliary for monitoring by the safety monitoring relay
- PLC Compatible—The N/O off delayed output makes it possible to use the SR106ED on machines with





  
 Conforms to EN60204-1, EN954-1, VDE 0113-1  
 UL and C-UL listed  
 TÜV Rheinland approved

programmable logic controllers that require some time to execute an orderly shutdown

## Ordering Information

Model	Part Number	Description
SR106ED01	44510-1061	SR106 BASE MODEL, 24VAC/DC, 1 INPUT, 3 OFF DELAYED OUTPUTS, 1 AUX.

# SR107, 108 & 109AD Safety Monitoring Relays

**Quick Link**  
**S375**  
 omron247.com

## Dual-Channel Monitoring Relay

- Power requirements—the SR107AD, SR108AD and SR109AD will accept 24 VAC/DC
- Inputs—the SR107AD, SR108AD and SR109AD will accept single or dual N/C inputs or dual PNP solid-state inputs from a light curtain
- Outputs—the SR107AD, SR108AD and SR109AD have a total of 4 N/O outputs with 3, 2 or 1 of the outputs with a time delay of 1-30 sec.
- External Device Monitoring (EDM) is provided with a N/C loop between S12 and S21 on the SR107AD, SR108AD and SR109AD
- Reset mode—a monitored manual start or an auto/manual start may be configured with the SR107AD, SR108AD and SR109AD. Monitored manual reset requires closure of the reset circuit followed





  
 Conforms to EN60204-1, EN954-1, EN292, VDE 0113-1  
 UL and C-UL listed, BG approved

- by opening of the circuit. Reset occurs when circuit is opened. Auto reset requires only closure of the reset circuit as reset occurs when circuit is closed.
- PLC Compatible—The N/O off delayed outputs make it possible to use the SR107AD, SR108AD and SR109AD on machines with Programmable Logic Controllers that require some time to execute an orderly shutdown

## Ordering Information

Model	Part Number	Description
SR108AD01	44510-1081	SR108 BASE MODEL, 24VAC/DC, 2 INPUTS, 2 OUTPUTS, 2 DELAYED OUTPUTS

## Stop Motion Sensing Unit

- Power requirements—the SR125SMS45 will accept 24 VDC or 110 VAC
- Motion detection input—the SR125SMS45 detects the stop condition of all types of AC or DC motors by sensing the motor's back EMF across terminals Z1, Z2 and Z3
- Drive compatible—the SR125SMS45 will function with electronic motor control devices such as variable speed controllers, DC injection brakes, etc.
- Selectable speed limit—the SR125SMS45 has 1 N/O and 1 N/C outputs that are switched when motor speed reaches the adjustable preset limit (0.01 to 0.10 V) for the particular output
- Auxiliary output—the SR125SMS45 has 2 solid state auxiliary signaling outputs



CE UL S&B  
Conforms to EN60204-1, EN292, and EN692  
UL listed, CSA and BG approved

## Ordering Information

Model	Part Number	Description
SR125SMS4501	44510-1271	SR125 BASE MODEL, 24 VDC, BACK EMF SENSING, 1NO+1NC, 2 SOLID STATE

HH

# SR131A Safety Monitoring Relays

Quick Link

S378

omron247.com

## Dual-Channel Monitoring Relay

- Power requirements—the SR131A will accept 24 VDC
- Inputs—The SR131A is designed to monitor two magnetically encoded non-contact switches with 1 N/C and 1 N/O contacts
- Outputs—the SR131A has 2 N/O outputs to route power to the coils of external device power contactors plus 2 N/C auxiliary solid state outputs for signaling purposes
- External Device Monitoring (EDM) is provided with a N/C loop between Y1 and Y2 on the SR131A



Conforms to EN60204-1, EN954-1, EN292, and EN1088  
UL and C-UL listed, CSA and BG approved

- Selectable reset modes—automatic/manual reset mode is available on the SR131A

## Ordering Information

Model	Part Number	Description
SR131A00	44510-1310	SR131 BASE MODEL, 24VDC, 2 INPUTS (TWO), 2 OUTPUTS, 2 SOLID STATE AUX.

# SR203M & 203AM Safety Monitoring Relays

Quick Link

S382

omron247.com

## Dual-Channel Monitoring Relay

- Power requirements—the SR203M/A will accept 24 VAC/DC or 115 VAC
- Inputs—the SR203M/A will accept single or dual N/C inputs or dual PNP inputs from a light curtain
- Outputs—the SR203M/A has 3 N/O outputs to route power to the coils of power contactors, plus 1 N/C auxiliary output for signaling purposes
- External Device Monitoring (EDM) is provided with a N/C loop between S12 and S34 on the SR203M/A



Conforms to EN60204-1, EN954-1, ISOTR 12100  
UL and C-UL listed

- Monitored manual or automatic/manual reset modes are available on the SR203M/A
- The SR203M/A have removable terminal blocks

SR203AM

Quick Link

S383

omron247.com

## Ordering Information

Model	Part Number	Description
SR203A01	44510-2031	SR203 BASE MODEL, 24VAC/DC, 2 INPUTS, 3 OUTPUTS, 1 N/C AUX.

## Dual-Channel Safety Monitoring Relay

- Power requirements—the SR208AD/209AD will accept 24 VAC/DC or 115 VAC
- Inputs—the SR208AD/209AD will accept single or dual N/C inputs or dual PNP inputs from a light curtain
- Outputs—the SR208AD has 2 N/O immediate outputs plus 3 N/O delayed outputs. The SR209AD has 2 N/O immediate outputs plus 2 N/O and 1 N/C delayed outputs to route power to the coils of power contactors (selectable from 0.5 to 10 sec)
- External Device Monitoring (EDM) is provided with a N/C loop between Y1 and Y2 on the SR208AD/209AD
- Reset mode—monitored manual or automatic/manual reset modes are available on the SR208/209AD



- PLC Compatible—The N/O off delayed outputs make it possible to use the SR208AD/209AD on machines with Programmable Logic Controllers that require some time to execute an orderly shut-down. The N/C on delayed output of the SR209AD may be used to apply power for unlocking a solenoid locking switch
- The SR208AD/209AD have removable terminal blocks

## Ordering Information

Model	Part Number	Description
SR208AD01	44510-2081	SR208 BASE MODEL, 24VAC/DC, 2 INPUTS, 2 OUTPUTS, 3 DELAYED OUTPUTS
SR209AD01	44510-2091	SR209 BASE MODEL, 24VAC/DC, 2 INPUTS, 2 OUTPUTS, DELAYED OUTPUTS 2N/O+1N/C

## Compact, Slim Relays Conforming to EN Standards

- Relays with forcibly guided contacts (EN50205 Class A, certified by VDE)
- Supports the CE marking of machinery (Machinery Directive)
- Helps avoid hazardous machine status when used as part of an interlocking circuit
- Four-pole and six-pole relays are available
- The relay's terminal arrangement simplifies PWB pattern design



- Reinforced insulation between inputs and outputs. Reinforced insulation between some poles of different polarity

## Ordering Information

Model	Part Number	Description
G7SA-2A2B DC24	11051-0002	G7SA BASE MODEL, 2NO+2NC, 24VDC, FORCE GUIDED RELAY
G7SA-3A1B DC24	11051-0001	G7SA BASE MODEL, 3NO+1NC, 24VDC, FORCE GUIDED RELAY
G7SA-3A3B DC24	11051-0005	G7SA BASE MODEL, 3NO+3NC, 24VDC, FORCE GUIDED RELAY
G7SA-4A2B DC24	11051-0004	G7SA BASE MODEL, 4NO+2NC, 24VDC, FORCE GUIDED RELAY
G7SA-5A1B DC24	11051-0003	G7SA BASE MODEL, 5NO+1NC, 24VDC, FORCE GUIDED RELAY
P7SA-10F	11059-0012	G7SA 4 POLE SOCKET, TRACK MOUNTING, NO LED
P7SA-10F-ND DC24	11059-0010	G7SA 4 POLE SOCKET, TRACK MOUNTING, LED
P7SA-10P	11059-0008	G7SA 4 POLE SOCKET, BACK MOUNTING, NO LED
P7SA-14F	11059-0009	G7SA 6 POLE SOCKET, TRACK MOUNTING, NO LED
P7SA-14F-ND DC24	11059-0011	G7SA 6 POLE SOCKET, TRACK MOUNTING, LED
P7SA-14P	11059-0007	G7SA 6 POLE SOCKET, BACK MOUNTING, NO LED

# G7S-□-E Force-Guided Relays

## Lineup Now Includes 10-A Models

- Relays with forcibly guided contacts (EN50205 Class A, certified by VDE)
- Supports the CE marking of machinery (Machinery Directive)
- Helps avoid hazardous machine status when used as part of an interlocking circuit
- Track-mounting and back-mounting sockets are available

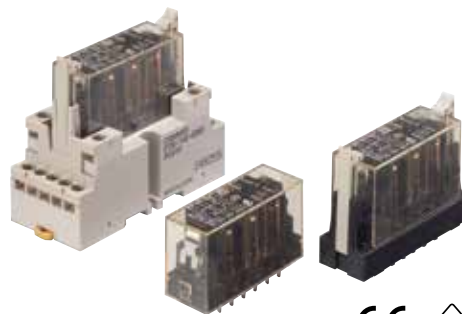

## Ordering Information

Model	Part Number	Description
G7S-3A3B-E DC24	11052-0001	G7S-E BASE UNIT, 6 POLES, 3PST-NO, 3PST-NC
G7S-4A2B-E DC24	11052-0002	G7S-E BASE UNIT, 6 POLES, 4PST-NO, DPST-NC
P7S-14F-END DC24	11060-0001	G7S-E, TRACK-MOUNT SOCKET, 24VDC

## Model Number Index

Family	Section-Page	Family	Section-Page	Family	Section-Page
3G3DV	H-5	E2E – Miniature	L-11	E3X-HD	K-12
3G3JX	H-2	E2E – Standard	L-1	E3X-MDA	K-17
3G3MX2	H-3	E2E2 AC 2-wire	L-10	E3X-NA	K-14
3G3RX	H-4	E2E2 DC 2-wire	L-7	E3X-NA-F	K-17
3Z4S-LE	P-13	E2E2 DC 3-wire	L-8	E3X-SD	K-14
A	O-10	E2EC	L-12	E3Z	J-4
A16/A165	Z-6	E2EH	L-21	E3Z-B	J-11
A165E	FF-7	E2EM	L-5	E3Z-F	J-5
A165K	Z-8	E2EQ	L-22	E3Z-G	J-11
A165S/A165W/A165LW	Z-7	E2E-U	L-22	E3Z-K	J-14
A22E	FF-6	E2EV	L-25	E3Z-L	J-12
A22R/A22RL	Z-3	E2EY	L-26	E3Z-L□	J-6
A22RK	Z-4	E2EZ	L-26	E3Z-LS	-J-13
A22RS/A22RW	Z-4	E2F	L-18	E3ZM	J-7
A22TK	GG-6	E2FM	L-19	E3ZM-B	J-10
A3U	Z-5	E2FQ	L-23	E3ZM-C	J-8
A4EG	GG-7	E2K-C	L-16	E3ZM-V	J-9
C200H-MC402-E	F-4	E2K-F	L-17	E4E-N	O-5
C200HW-NC□□	F-7	E2K-L	L-17	E5AC	T-4
CJ1W-NC□71	F-3	E2K-X	L-23	E5AC-T	T-9
CJ1W-NC□8□	F-2	E2K-X	L-15	E5AN-H/E5EN-H	T-13
CJ2	B-2	E2Q5	L-14	E5AN-HT/E5EN-HT	T-14
CM	EE-13	E2S	L-14	E5AR/E5ER	T-18
CP1E	B-17	E32 - Area Monitoring	K-10	E5C2	T-16
CP1H	B-15	E32 - Built-in Lens	K-5	E5CB	T-1
CP1L	B-16	E32 - Chemical Resistant	K-6	E5CC	T-2
CR	I-3	E32 - Heat Resistant	K-7	E5CC-T	T-7
CRT1	C-6	E32 - Longer Distance	K-4	E5CC-U	T-6
CS1	B-9	E32 – Miniature	K-3	E5CN-H	T-11
CS1W-MC□21	F-5	E32 - Precision Detection	K-9	E5CN-HT	T-12
CS1W-NC□□3	F-6	E32 - Robot Application	K-5	E5CSV	T-15
CX-One	E-2	E32 - Special Application	K-11	E5DC	T-5
D40Z/D40A/G9SX-N	EE-15	E32 - Square Shape	K-2	E5EC	T-3
D4A-N	O-3	E32 - Standard Cylindrical	K-1	E5EC-T	T-8
D4B-□N	GG-4	E32 - Vacuum Resistant	K-8	E5GC	T-10
D4C	O-4	E39-L	J-24	E5ZN	T-19
D4CC	O-4	E39-R	J-24	E6A2-C	R-5
D4F	GG-5	E39-VA	M-10	E6B2-C	R-6
D4GS-N	EE-7	E3C-LDA	J-20	E6C3-A	R-2
D4JL	EE-12	E3FA/E3RA	J-1	E6C3-C	R-7
D4MC	O-5	E3FB/E3RB	J-2	E6CP-A	R-3
D4N	GG-2	E3FC	J-3	E6D-C	R-8
D4NH	EE-18	E3G	J-15	E6F-A	R-4
D4NL	EE-9	E3G-M	J-16	E6F-C	R-8
D4N-□R	GG-3	E3JM	J-16	EE-SA701/801	N-16
D4NS	EE-2	E3K	J-18	EE-SPW311/411	N-12
D4SL-N	EE-8	E3NC-L/E3NC-S	J-19	EE-SPW321/421	N-13
D5B	O-7	E3NX-FA	K-13	EE-SPX301/EE-SPX401	N-7
DRT2 In-panel	C-4	E3S-A	J-18	EE-SPX303N/403N	N-9
DRT2 On-machine	C-5	E3S-C	J-22	EE-SPX613	N-14
DST1	CC-4	E3S-CL	J-15	EE-SPX74□/EE-SPX84□	N-6
DV	H-5	E3T	J-17	EE-SPX-W2A	N-8
DZ	O-12	E3X-DAC-S	K-18	EE-SPY301/302/401/402	N-7
E2A	L-4	E3X-DAH-S	K-18	EE-SPY31□/41□	N-10
E2A3	L-6	E3X-DA-S	K-15	EE-SPY801/802	N-17
E2B	L-3	E3X-DA-SE-S	K-16	EE-SPZ-A	N-15
E2C-EDA	L-24	E3X-ECT/CRT/		EE-SX47□/EESX-67□	N-3
E2CY	L-25	DRT21S/DRT21/CIF11	K-19	EE-SX77□/EE-SX87□	N-2

## Model Number Index

Family	Section-Page	Family	Section-Page	Family	Section-Page
EESX95□	N-1	H7BX	V-11	R88M-G	G-6
EE-SX97□	N-5	H7CN	V-11	R88M-K	G-5
EE-SY671/672	N-11	H7CX-N	V-9	RM-1	AA-7
EJ1	T-20	H7EC/H7ET/H7ER	V-10	RM-2/RM-2AC/RM-2AC-IP	AA-7
ER1022, ER1032	FF-5	H7GP	V-12	RM-3	AA-8
ER5018	FF-2	H7HP	V-13	RM-X	AA-8
ER6022	FF-3	H8PS	F-8	RX	H-4
ER6022-SS	FF-4	Hawk	S-4	S8JX-G	U-6
ERT1	C-7	HS/MobileHawk	S-5	S8JX-P	U-7
F3ET2, F3EM2	J-21	JX	H-2	S8VK-G	U-2
F3SG-R	AA-2	K3GN	W-3	S8VK-R	U-3
F3SJ-A	AA-4	K3HB -X, -H, -V, -S	W-1	S8VK-T	U-8
F3SJ-B	AA-5	K3HB-C, -P, -R	W-2	S8VM	U-5
F3SJ-E	AA-6	K3MA-J, -L, -F	W-3	S8VS	U-4
F3UV	J-23	K7L-AT50	X-8	SCADA	E-4
FH	P-7	K8AK-AS	X-2	SCC	DD-4
FL	P-10	K8AK-AW	X-3	SCSF	DD-3
FL-V	P-11	K8AK-LS	X-7	SGE, SCS	DD-3
FQ2	P-2	K8AK-PA/K8AK-PM/K8AK-PW	X-4	SHL	O-6
FQ-CR	S-8	K8AK-PH/K8DS-PH	X-5	SR101A	HH-2
FQ-M	P-3	K8AK-TH	T-17, X-6	SR103AM	HH-3
FZ/FH Accessories	P-6	K8AK-VS/K8AK-VW	X-1	SR104P	HH-3
FZ/FH Cameras	P-5	LY	Y-4	SR106ED	HH-3
FZ5-L	P-4	M16/M165	Z-9	SR107/SR108/SR109AD	HH-4
FZ-LE	P-13	M22R	Z-2	SR125SMS345	HH-5
G2R□-S	Y-2	M2BJ	Z-10	SR131A	HH-6
G2RV	Y-1	MA	EE-14	SR203M, SR203AM	HH-6
G3MC	Y-19	MA-S	EE-16	SR208, SR209AD	HH-7
G3NA	Y-12	MC	DD-2	Sysmac NJ Series	F-1
G3NE	Y-11	MFS	EE-17	Sysmac NJ System	A-2
G3PA	Y-14	MGN	Y-10	Sysmac NX System	A-1
G3PE	Y-15	MJN	Y-6	Sysmac Studio	E-1
G3PF	Y-16	MKS	Y-5	T2008	EE-6
G3PH	Y-13	MKS-X	Y-7	T4012	EE-4
G3R-I/O	Y-18	MS-3	S-1	T4016	EE-5
G3RV	Y-17	MS4800/MSF4800	AA-3	T5009, T5009-6	EE-3
G3TB	Y-20	MX2	H-3	TCS1400	S-6
G3ZA	T-21	MY	Y-3	TCS1490	S-6
G7J	Y-8	NA5	D-2	TL4019	EE-10
G7SA	HH-8	NB	D-6	TL4024	EE-11
G7S-□-E	HH-8	NE1A	CC-3	TL-W	L-13
G7TC/G70A/G70D	C-11	NJ I/O	A-4	TS	GG-8
G7Z	Y-9	NJ501-4	I-2	TZ	O-12
G9SA	HH-2	NS	D-3	UMQ	DD-1
G9SP	CC-2	NSJ	D-4	V400-H	S-7
GRT1	C-3	NS-Runtime	E-6	V400-R2	S-9
GX	C-8	NT11	D-8	V500-R2	S-9
GX-JC	C-13	NT2S	D-9	V640	S-13
H3CA	V-2	NV3/NV4	D-7	V680	S-11
H3CR	V-3	NX	C-1	V680-HAM42-DRT	S-12
H3DK	V-5	NX-S	C-2, CC-1	V680-HAM91/HAM81	S-12
H3DS	V-6	OS32C	BB-2	V680S	S-10
H3JA	V-4	PA4600	AA-9	V750	S-14
H3YN	V-4	QX830	S-2	VB	O-7
H5CX-N	V-1	QX870	S-3	WL-N	O-2
H5F	V-8	R7D□-B	G-4	X	O-11
H5L	V-8	R88D-KN, R88D-KT	G-2	XS2F/XS2W	M-2
H5S	V-7	R88D-KN□□-ECT-L	G-3	XS3F/XS3W	M-6



<b>Family</b>	<b>Section-Page</b>
XS5/XS6 Ethernet Media.....	C-12
XS5F.....	M-5
XW2.....	C-9
XW3D.....	M-10
Y96E-M12.....	M-9
Z.....	O-9
ZAP.....	Z-10
ZE/Z/ZV2.....	O-8
ZEN.....	B-20
ZG2.....	Q-10
ZS-HL.....	Q-5
ZS-L.....	Q-4
ZW.....	Q-8
ZX1.....	Q-1
ZX2.....	Q-2
ZX-E.....	Q-6
ZX-GT.....	Q-9
ZX-L-N.....	Q-3
ZX-T.....	Q-7

## NEMA Ratings

NEMA (National Electrical Manufacturers Association) ratings ensure protection against the following environmental conditions.

Environmental Conditions	Type of Enclosure													
	1	2	3	3R	3S	4	4X	5	6	6P	11	12	12K	13
Accidental contact with the enclosed equipment	X	X	X	X	X	X	X	X	X	X	X	X	X	X
Falling dirt	X	X	--	--	--	X	X	X	X	X	X	X	X	X
Falling liquids, light splashing	--	X	--	--	--	X	X	--	X	X	X	X	X	X
Dust, lint, fibers and flyings (non-combustible, non-ignitable)	--	--	--	--	--	X	X	X	X	X	--	X	X	X
Windblown dust	--	--	X	--	X	X	X	--	X	X	--	--	--	--
Hosedown and splashing water	--	--	--	--	--	X	X	--	X	X	--	--	--	--
Oil and coolant seepage	--	--	--	--	--	--	--	--	--	--	--	X	X	X
Oil or coolant spraying and splashing	--	--	--	--	--	--	--	--	--	--	--	--	--	X
Corrosive agents	--	--	--	--	--	--	X	--	--	X	X	--	--	--
Occasional temporary submersion	--	--	--	--	--	--	--	--	X	X	--	--	--	--
Occasional prolonged submersion	--	--	--	--	--	--	--	--	--	X	--	--	--	--

## IP Ratings

The IEC (International Electrotechnical Commission) defines degrees of protection provided by electrical enclosures with respect to personnel, equipment within the enclosure and ingress of water. The degree of protection is expressed by the letters "IP" followed by two numerals (Example: IP67). See the table below for an explanation of the numerals.

The following information is drawn from publication IEC 60529 of 2004 and 529 of 1989.

By contrast to NEMA, "IP" ratings do not apply to protection against the risk of explosion or conditions such as humidity, corrosive gases, fungi or vermin. Also, different parts of a piece of equipment can have different degrees of protection and still comply with the standards. An example would be the opening in the base of an enclosure.

1st characteristic numeral		2nd characteristic numeral	
Protection against contact and penetration of solid bodies.		Protection against the penetration of liquids.	
0	Not protected	0	Not protected
1	Protection against solid objects greater than 50 mm	1	Protection against dripping water
2	Protection against solid objects greater than 12 mm	2	Protection against dripping water when tilted up to 15°
3	Protection against solid objects greater than 2.5 mm	3	Protection against spraying water
4	Protection against solid objects greater than 1 mm	4	Protection against splashing water
5	Dust protected	5	Protection against water jets
6	Dust tight	6	Protection against heavy seas
--		7	Protection against the effects of immersion
--		8	Protection against submersion
--		9K	Protection against steam jet cleaning

# Social Responsibility

## WORKING FOR THE BENEFIT OF SOCIETY

Our approach to product development and business is guided by core values based on serving the needs of society. This is reflected in the Omron corporate motto...

*“At work for a better life, a better world for all.”*

Conceived by Omron’s founder Kazuma Tateisi, these words reflect his pioneering idea that a company should fulfill its responsibility to society rather than solely focusing on productivity, efficiency, sales and profits. Our unending commitment to identifying social needs is embedded in Omron’s corporate DNA, along with a challenge-oriented spirit capable of responding to those needs.

The Omron Foundation in the Americas funds charitable donations for disaster relief and recovery efforts, and matches individual employee donations to social support, education, and cultural enrichment organizations. Each year on May 10, Omron employees around the world actively participate in charitable activities to honor the core values established by the company’s founder. Throughout the year, Omron offers team and individual opportunities at partner charitable organizations to underscore the need for social responsibility as a corporate priority.



### ENVIRONMENTAL PROTECTION

Providing environmentally safe products to the world.

Omron’s social responsibility also takes the form of decisions and actions that help preserve and restore the environment. Far in advance of directives banning the use of harmful chemicals in making electronics (RoHS), Omron adopted an ECO policy that works to eliminate these and other pollutants. The policy also mandates significant reductions in power consumption to conserve energy and natural resources for future generations.



## OMRON AUTOMATION AND SAFETY • THE AMERICAS HEADQUARTERS

Chicago, IL USA • 847.843.7900 • 800.556.6766 • [www.omron247.com](http://www.omron247.com)

### OMRON CANADA, INC. • HEAD OFFICE

Toronto, ON, Canada • 416.286.6465 • 866.986.6766 • [www.omron247.com](http://www.omron247.com)

### OMRON ELECTRONICS DE MEXICO • HEAD OFFICE

México DF • 52.55.59.01.43.00 • 01-800-226-6766 • [mela@omron.com](mailto:mela@omron.com)

### OMRON ELECTRONICS DE MEXICO • SALES OFFICE

Apodaca, N.L. • 52.81.11.56.99.20 • 01-800-226-6766 • [mela@omron.com](mailto:mela@omron.com)

### OMRON ELETRÔNICA DO BRASIL LTDA • HEAD OFFICE

São Paulo, SP, Brasil • 55.11.2101.6300 • [www.omron.com.br](http://www.omron.com.br)

### OMRON ARGENTINA • SALES OFFICE

Cono Sur • 54.11.4783.5300

### OMRON CHILE • SALES OFFICE

Santiago • 56.9.9917.3920

### OTHER OMRON LATIN AMERICA SALES

54.11.4783.5300

**OMRON EUROPE B.V.** • Wegalaan 67-69, NL-2132 JD, Hoofddorp, The Netherlands. +31 (0) 23 568 13 00 • [www.industrial.omron.eu](http://www.industrial.omron.eu)

*Authorized Distributor:*

#### Automation Control Systems

- Machine Automation Controllers (MAC) • Programmable Controllers (PLC)
- Operator interfaces (HMI) • Distributed I/O • Software

#### Drives & Motion Controls

- Servo & AC Drives • Motion Controllers & Encoders

#### Temperature & Process Controllers

- Single and Multi-loop Controllers

#### Sensors & Vision

- Proximity Sensors • Photoelectric Sensors • Fiber-Optic Sensors
- Amplified Photomicrosensors • Measurement Sensors
- Ultrasonic Sensors • Vision Sensors

#### Industrial Components

- RFID/Code Readers • Relays • Pushbuttons & Indicators
- Limit and Basic Switches • Timers • Counters • Metering Devices
- Power Supplies

#### Safety

- Laser Scanners • Safety Mats • Edges and Bumpers • Programmable Safety Controllers • Light Curtains • Safety Relays • Safety Interlock Switches

Printed on recycled paper. ♻️